

Table of Contents

Before Operation

1

Product Overview

1.1	Components of the screwdriver system	1-2
1.2	Model overview.....	1-3
1.2.1	Nameplate information	1-3
1.2.2	Model explanation	1-5
1.2.3	Product specifications	1-7
1.3	ASA servo screwdriver controller and servo screwdriver	1-9
1.4	Part names of the servo screwdriver controller.....	1-10
1.5	Part names of the servo screwdriver.....	1-12

2

Installation

2.1	Ambient storage conditions	2-2
2.2	Ambient installation conditions	2-2
2.3	Mounting direction and space	2-3
2.4	The use and installation of the servo screwdriver	2-4
2.5	Dimensions.....	2-6
2.6	Safety precautions for using the smart servo screwdriver system.....	2-8
2.7	Maintenance	2-9

3

Wiring

3.1	System connection	3-2
3.1.1	Connection diagrams	3-2
3.2	Wiring for I/O connector.....	3-3
3.2.1	I/O connector	3-3
3.2.2	Signal explanation for i/o connector.....	3-5
3.2.3	Wiring diagrams.....	3-6
3.3	RS232	3-8
3.4	RS485 (used for extension)	3-9

Operation and Setting

4

Functions Overview

4.1 Functions overview	4-2
4.1.1 Major functions	4-3

5

Parameters (Tightening Parameters)

5.1 Parameters overview	5-2
5.2 Create parameters	5-3
5.3 Tightening strategies and the Settings tabs	5-6
5.3.1 General settings	5-7
5.3.2 Tightening settings	5-8
5.3.2.1 Standard strategy	5-8
5.3.2.2 Enhanced strategy	5-14
5.3.2.3 Pre-position strategy	5-15
5.3.2.4 Self-defined strategy	5-17
5.3.3 Loosening settings	5-21
5.4 Save parameters	5-22
5.5 Copy and paste parameters	5-22
5.6 Delete parameters	5-24
5.7 Import / export parameters	5-25

6

Sequence (Tightening Sequence)

6.1 Tightening sequence overview	6-2
6.2 Add a tightening sequence	6-4
6.3 Save a tightening sequence	6-9
6.4 Copy / paste a tightening sequence	6-10
6.5 Delete a tightening sequence	6-12
6.6 Export / import a tightening sequence	6-13

7

Sources (Tightening Source)

7.1 Operation Mode	7-2
7.2 Switching Method	7-4
7.2.1 Manual (Manual setting)	7-5
7.2.2 Screw Bit Selector	7-8
7.2.3 Barcode Scanner	7-12
7.3 Copy a tightening source	7-16
7.4 Delete a tightening source	7-19
7.5 Export / import a tightening source	7-20

8

Results

8.1 Result (Operation results)	8-2
8.2 Curve (Operating curve)	8-8

9

Controller

9.1 System settings	9-2
9.2 DI/DO	9-8
9.3 Peripheral device	9-9
9.4 Communication	9-12
9.5 Service Station	9-13

10

Tool

10.1 Tool Info	10-2
10.2 Tool Settings	10-3
10.3 Led Light Settings	10-5
10.4 Tool Calibration	10-6

11

Reports

11.1 Production Report	11-2
11.2 Error Report	11-3
11.3 Warning Report	11-4

12

Modbus communications

12.1 System structure	12-2
12.2 Operational status of the smart servo screwdriver system	12-3
12.3 Handshake data of the smart servo screwdriver system	12-6
12.4 Examples of tightening parameter operations	12-8
#100 Write the parameters	12-8
#150 Read the parameters	12-9

Troubleshooting

13 Troubleshooting

13.1 Alarm list	13-2
13.1.1 Device alarms.....	13-2
13.1.2 Tightening errors	13-2
13.1.3 Operation warnings.....	13-6
13.2 Causes and corrective actions.....	13-7
13.2.1 Description of device alarms	13-7
13.2.2 Description of tightening errors	13-10
13.2.3 Description of operation warnings	13-35

Appendix

A Modbus communications - Function Codes

A.1 System structure.....	A-3
A.2 Operational status of the smart servo screwdriver system	A-8
A.3 Handshake data of the smart servo screwdriver system	A-12
A.3.1 Parameters operations.....	A-14
#100 Write the parameters	A-14
#150 Read the parameters	A-18
A.3.2 Sequence operations.....	A-21
#200 Write the sequence	A-21
#250 Read the sequence	A-34
A.3.3 Sources operations	A-48
#300 Write the operation mode and switching method of Sources.....	A-48
#301 Write the contents of single source settings	A-49
#350 Read the operation mode and switching method of Sources.....	A-52
#351 Read the contents of single source settings.....	A-53
A.3.4 Results operations	A-56
#400 Write the switching method of Sources	A-56
#401 Write the scanner string	A-57
#402 Write to clear all errors	A-59
#403 Write to reset the operation progress.....	A-60
#404 Write to execute the previous step.....	A-61
#405 Write to execute the next step	A-62
#406 Write to restrict tightening operation	A-63

#407 Write to restrict loosening operation	A-64
#408 Write the scanner advanced settings.....	A-65
#450 Read the switching method of Sources	A-66
#451 Read the scanner string	A-68
#452 Read the scanner advanced settings	A-69
A.3.5 Controller operations	A-71
#500 Write the request for permissions login	A-72
#501 Write the request for password change.....	A-73
#502 Write the request for permissions logout	A-75
#503 Write the page permissions.....	A-76
#504 Write the Ethernet settings.....	A-77
#505 Request for factory reset	A-79
#506 Write the buzzer sound pattern	A-80
#507 Write the DI/DO functions	A-81
#508 Write the DI/DO conversion table	A-83
#509 Write the default torque unit	A-91
#510 Write the default tool start condition	A-92
#550 Read the Ethernet settings.....	A-93
#551 Read the page permissions.....	A-94
#552 Read the firmware version	A-95
#553 Read the DI/DO functions.....	A-96
#554 Read the DI/DO conversion table	A-99
#555 Read the default torque unit	A-106
#556 Read the default tool start condition	A-107
A.3.6 Tool operations.....	A-109
#600 Write to activate the tool.....	A-110
#601 Write to enable service reminder	A-111
#602 Write the lever start level	A-112
#603 Write the push start level	A-113
#604 Write the work light brightness	A-114
#606 Write the LED light settings.....	A-115
#607 Write the tool calibration.....	A-117
#650 Read the tool information.....	A-118
#651 Read the lever start level	A-119
#652 Read the push start level.....	A-120
#653 Read the work light brightness.....	A-122
#655 Read the LED light settings.....	A-123
#656 Read the tool calibration.....	A-125
A.3.7 Reports operations.....	A-126
#700 Clear the production report entries.....	A-127

#701 Clear the error and warning report entries	A-128
#750 Find and read the production report entries	A-129
#751 Find and read curves	A-132
#752 Find and read the error report entries	A-138
#753 Find and read the warning report entries	A-140

Preface

Thank you for purchasing this product. This manual provides information about the ASA ST1 Series Smart Servo Screwdriver System.

This manual includes:

- Installation and inspection of servo screwdriver controller and servo screwdriver
- Servo screwdriver controller structure and wiring diagram
- Description of functions overview
- Description of parameters
- Description of sequence
- Description of sources
- Description of results
- Description of controller
- Description of tool
- Description of reports
- Description of Modbus communications
- Troubleshooting
- Inspection and maintenance

Product features:

- Multiple tightening strategies: you can customize different tightening strategies for different tightening scenarios to achieve quality requirements.
- New generation motors: the compact design meets the need for reducing the size and weight of the equipment structures.

How to use this manual:

Use this manual as a reference when installing, setting up, using, and maintaining the servo screwdriver system.

ASA technical services:

Consult your ASA equipment distributor or ASA Customer Service Center if you encounter any problems.

Safety precautions

Pay special attention to the following safety precautions at all times during inspection, installation, wiring, operation, maintenance, and examination of the servo screwdriver system.

The symbols of “DANGER,” “WARNING”, and “STOP” indicate:



Danger. May cause severe or fatal injuries to personnel if the instructions are not followed.



Warning. May cause moderate injury to personnel, or lead to severe damage or even malfunction of the product if the instructions are not followed.



Absolutely prohibited activities. May cause serious damage or even malfunction of the product if the instructions are not followed.

Installation



- Do not expose the product to an environment containing vapor, corrosive gas, inflammable gas, or other foreign matter to reduce the risk of electric shock or fire.
- The system must be properly plugged in to a grounded outlet.
- Before plugging or unplugging the tool cable, make sure that the power to the controller has been turned off.

Operation



- This product can only be operated by professional-trained industrial assembly personnel.
- This product is designed for intermittent use. The general work cycle is run for 1 second then stop for 4 seconds. This product includes a protection mechanism to ensure that the acceptable work cycle (depending on the torque value and operation time) is not exceeded.



During the operation, do not touch any rotating tool parts, or it may cause personnel injury.

Maintenance and inspection



- Do not use cleaning fluids containing solvents to clean the tool parts or cables.
- Only authorized personnel can repair or restart the system.

1

Product Overview

Before using the ASA Tools smart servo screwdriver system, pay attention to the description of the inspection, nameplate, and model type. You can find a suitable servo screwdriver system in the table in Section 1.3.

1.1	Components of the screwdriver system	1-2
1.2	Model overview	1-3
1.2.1	Nameplate information.....	1-3
1.2.2	Model explanation	1-5
1.2.3	Product specifications.....	1-7
1.3	ASA Tools servo screwdriver controller and servo screwdriver.....	1-9
1.4	Part names of the servo screwdriver controller	1-10
1.5	Part names of the servo screwdriver	1-12

1.1 Components of the screwdriver system

A complete ASA Tools smart servo screwdriver system includes:

- (1) A servo screwdriver controller
- (2) A servo screwdriver (two servo screwdrivers for dual-tool controllers)
- (3) A connection cable (two connection cables for dual-tool controllers) with M16 8-pin circular connectors on both ends. It is used for connecting the servo screwdriver to the servo screwdriver controller.
- (4) Power supply for the servo screwdriver controller:















Model	Control circuit
ST1-1	100 to 240 Vac
ST1-2	100 to 240 Vac

1.2 Model overview

1.2.1 Nameplate information

ASA Tools smart servo screwdriver system - servo screwdriver controller

■ Nameplate information

		ASA TOOLS ENTERPRISE CO.
Model name - - -	MODEL: ST1-1	
Capacity specification - - -	POWER: 100W	
Applicable power supply - - -	INPUT: 100~240Vac 50~60Hz	C LISTED US
Rated power output - - -	OUTPUT: 38Vdc 0~900Hz 3.7A	
Serial number - - -	ST11T22050001	
Serial number QR code		
Firmware version - - -	0.41	
Label part number - - -	Part No. 7L7233	
	2F-1., No. 346, Sec. 6, Nanjing E. Rd., Neihu Dist., Taipei City 11470	
		MADE IN TAIWAN
		WARNING DISCONNECT ALL POWER AND WAIT 10 MINUTES BEFORE SERVICING. RISK OF ELECTRIC SHOCK.
		CAUTION DO NOT TOUCH HEATSINK WHEN POWER IS ON. MAY CAUSE BURN.
		CAUTION READ THE USER MANUAL BEFORE OPERATION.
		USE PROPER GROUNDING TECHNIQUES.

■ Serial number

ST11	T	22	05	0001	(1) Model name
(1)	(2)	(3)	(4)	(5)	(2) Manufacturing plant (T: Taiwan)
					(3) Year of production (22: year 2022)
					(4) Week of production (from 1 to 52)
					(5) Production sequence in a week (starting from 0001)

ASA Tools smart servo screwdriver system - servo screwdriver

■ **Nameplate information**

1

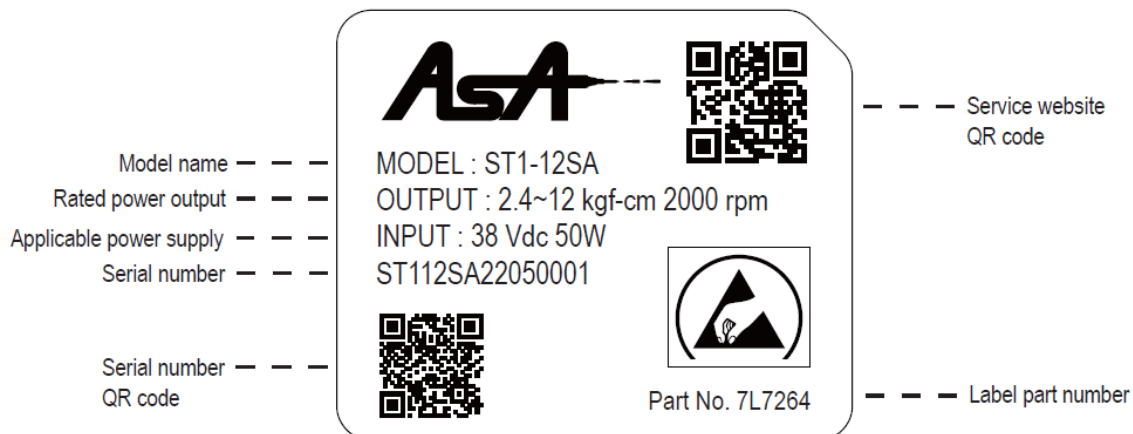

■ **Serial number**

ST112SA 22 05 0001
 (1) (2) (3) (4)

- (1) Model name
- (2) Year of production (22: year 2022)
- (3) Week of production (from 1 to 52)
- (4) Production sequence in a week (starting from 0001)

1.2.2 Model explanation

ASA Tools smart servo screwdriver system - servo screwdriver controller

$$\frac{ST}{(1)} \frac{1}{(2)} - \frac{1}{(3)}$$

1

(1) Product name

ST: Smart Tool

(2) Series

1: Screw Driver 1 series

(3) Number of tools

1: single-tool

2: dual-tool

ASA Tools smart servo screwdriver system - servo screwdriver

$\frac{ST}{(1)}$ $\frac{1}{(2)}$ - $\frac{12}{(3)}$ - $\frac{S}{(4)}$ $\frac{A}{(5)}$

1

(1) Product name

ST: Smart Tool

(2) Series

1: Screw Driver 1 series

(3) Torque output

Code	Specifications
12	2.4 to 12 kgf-cm
30	6 to 30 kgf-cm
50	10 to 50 kgf-cm
75	15 to 75 kgf-cm

(4) Special code

S: standard type

(5) Bit specifications

A: 6.35 mm (1/4") hex head

B: 5 mm hex head

1.2.3 Product specifications

Servo screwdriver

Model	ST1-12SA ST1-12SB	ST1-30SA ST1-30SB	ST1-50SA ST1-50SB	ST1-75SA
Torque range (kgf-cm)	2.4 to 12	6 to 30	10 to 50	15 to 75
Maximum speed (rpm)	2000	1100	700	500
Torque precision	3%			
Weight	500 g			
Bit specifications	6.35 mm (1/4") hex head for the model name that ends with A 5 mm hex head for the model name that ends with B			
Operating temperature	0°C (-32°F) to 40°C (104°F)			
Storage temperature	-20°C (-4°F) to +60°C (140°F)			
Humidity	0% to 90% RH (non-condensing)			
IP rating	IP40			

1

Servo screwdriver controller

Model		ST1-1	ST1-2
Display	Panel type	10.1" TFT LCD (IPS full viewing angle)	
	Resolution	800 x 1280 24-bit RGB	
	Backlight	LED backlight (when room temperature < 25°C, half-life > 50,000 hours)	
	Brightness	500 cd/m ² (Typ.)	
Serial communication port		1 set for RS-232, 2 sets for RS-485	
Touchscreen		4-wire resistive touchscreen Operation expectance > 1,000,000	
Network interface		1 port, 10/100 Mbps auto-detection (with built-in isolated circuit)	
HDMI		1 port, HDMI 1.4a transmitter	
USB		1 USB Host Ver 2.0	
Power supply		50 / 60 Hz, 100 to 240 V _{AC}	
Supported number of tools (servo screwdrivers)		1	2
DC power output		1 set DC24V; max. output: 1A per tool	
Digital input / output		8 DOs (150mA max. output current) + 8 DIs (30 V _{DC} max) per tool	
Output voltage		38 V _{DC}	
Continuous output current		3.7 Arms per tool	
Max. instantaneous output current		15 Arms per tool	
Operating temperature		0°C (-32°F) to 40°C (104°F)	
Storage temperature		-20°C (-4°F) to +60°C (140°F)	
Humidity		0% to 90% RH (non-condensing)	
IP rating		IP20	

1.3 ASA Tools servo screwdriver controller and servo screwdriver

Servo screwdriver			Servo screwdriver controller		
Model	Torque output (kgf-cm)	Max. speed (rpm)	Model	Supported number of tools	Power supply
ST1-12SA ST1-12SB	2.4 to 12	2000	ST1-1	1	100 to 240 Vac
ST1-30SA ST1-30SB	6 to 30	1100			
ST1-50SA ST1-50SB	10 to 50	700			
ST1-75SA	15 to 75	500			
ST1-12SA ST1-12SB	2.4 to 12	2000	ST1-2	2	
ST1-30SA ST1-30SB	6 to 30	1100			
ST1-50SA ST1-50SB	10 to 50	700			
ST1-75SA	15 to 75	500			

List of models:

Item	Model	Description
Servo screwdriver	ST1-12SA	2.4 to 12 kgf-cm, 6.35 mm (1/4") hex head
	ST1-30SA	6 to 30 kgf-cm, 6.35 mm (1/4") hex head
	ST1-50SA	10 to 50 kgf-cm, 6.35 mm (1/4") hex head
	ST1-75SA	15 to 75 kgf-cm, 6.35 mm (1/4") hex head
	ST1-12SB	2.4 to 12 kgf-cm, 5 mm hex head
	ST1-30SB	6 to 30 kgf-cm, 5 mm hex head
	ST1-50SB	10 to 50 kgf-cm, 5 mm hex head
Servo screwdriver controller	ST1-1	100 to 240 Vac, 50 / 60Hz, 100W, single-tool
	ST1-2	100 to 240 Vac, 50 / 60Hz, 200W, dual-tool
Connection cable (with M16 8-pin circular connectors on both ends)	2W2140	Used for connecting the servo screwdriver to the controller (3 m)
	2W2142	Used for connecting the servo screwdriver to the controller (5 m)
	2W2144	Used for connecting the servo screwdriver to the controller (10 m)
Flange module (optional purchase, including a flange and fixing nut)	4V3034	Used for fixing the servo screwdriver to a screw tightening machine or a robotic arm

1.4 Part names of the servo screwdriver controller

Single-tool (controller model: ST1-1)

1

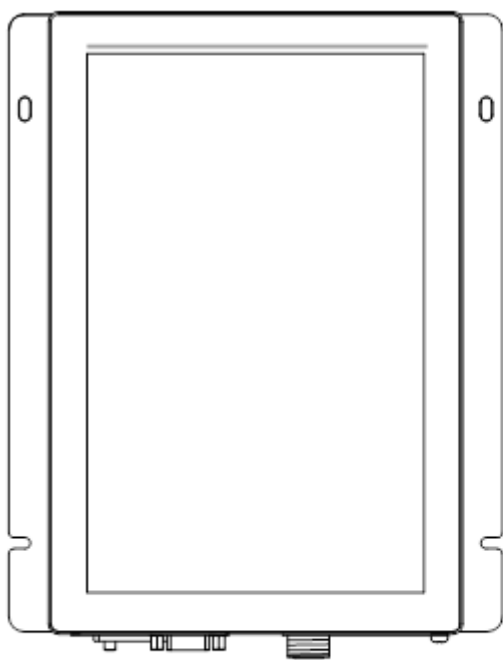

Front view

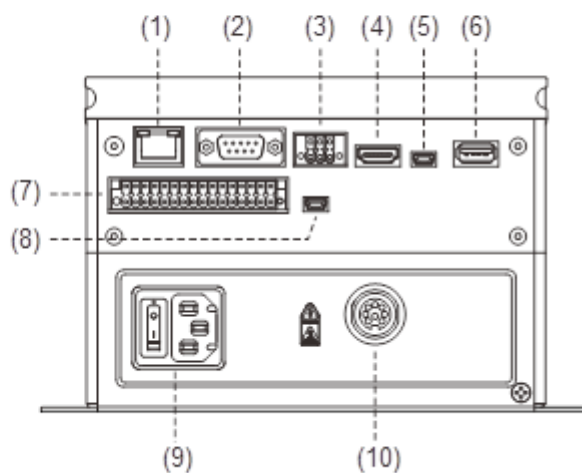

Bottom view

No.	Description	No.	Description
(1)	Standard RJ45 connector - connects to the host systems (PC/PLC/HMI)	(6)	Host connector a. Accesses the tightening data (parameters and results) b. Connects to the Barcode Scanner
(2)	Standard RS232 connector	(7)	Digital I/O port 1
(3)	Two RS485 connectors - connect to extra RS485 devices	(8)	SLAVE-B connector - for the controller firmware update
(4)	HDMI output - synchronously projects the operation screen to an external monitor	(9)	AC connector and switch
(5)	SLAVE-A connector - for the HMI software and firmware update	(10)	Tool-1 connector

Dual-tool (controller model: ST1-2)

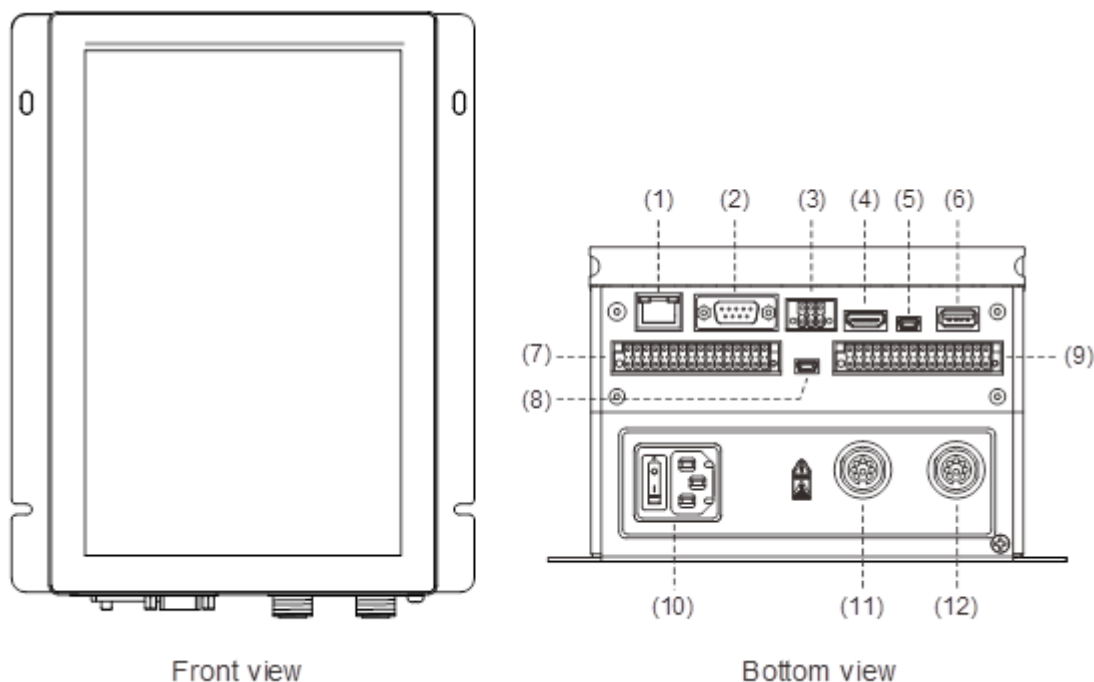

No.	Description	No.	Description
(1)	Standard RJ45 connector - connects to the host systems (PC/PLC/HMI)	(7)	Digital I/O port 1
(2)	Standard RS232 connector	(8)	SLAVE-B connector - for the controller firmware update
(3)	Two RS485 connectors - connect to extra RS485 devices	(9)	Digital I/O port 2
(4)	HDMI output - synchronously projects the operation screen to an external monitor	(10)	AC connector and switch
(5)	SLAVE-A connector - for the HMI software and firmware update	(11)	Tool-1 connector
(6)	Host connector a. Accesses the tightening data (parameters and results) b. Connects to the Barcode Scanner	(12)	Tool-2 connector

Pay special attention to the following when wiring:

1. The controller must be properly grounded to avoid the large power supply noise causing precision error for the servo screwdriver.
2. When the power is off, do not touch the main power cable since the large capacitor inside the controller still contains a dangerously large amount of electric charge.
3. Keep the connection cable at least 30 cm (11.8 inches) away from other signal wires.
4. Do not use any external capacitor, otherwise it may damage the controller.

1.5 Part names of the servo screwdriver

1

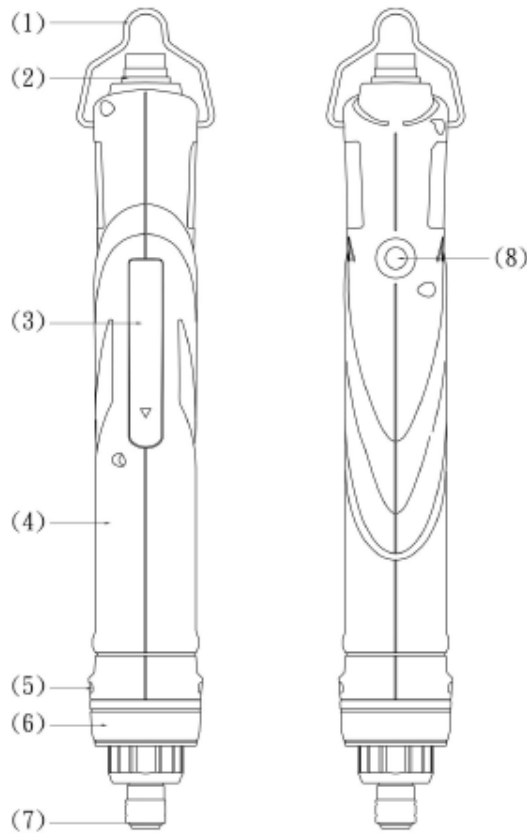

No.	Item	Description
(1)	Hanging ring	Used for hanging the servo screwdriver up for easy access.
(2)	Connector	Used for connecting the servo screwdriver and servo screwdriver controller.
(3)	Lever start	Press this lever to start the servo screwdriver.
(4)	Non-slip handle	Prevents the servo screwdriver from slipping out during handheld use.
(5)	Status LED indicator	Displays the current status of the servo screwdriver. The displayed status can be adjusted through LED Light Settings. Normal use: yellow Tightening NOK: red Tightening OK: green
(6)	Work light LED indicator	Provides solid white light under power supply. The brightness can be adjusted through Tool Settings.
(7)	Shaft of the servo screwdriver	Used for replacing the screw bit. Specification: 6.35 mm (1/4") hex head or 5 mm hex head.
(8)	CW / CCW switch	Used for switching the rotation direction for the servo screwdriver between clockwise (CW) and counterclockwise (CCW) to tighten or loosen the screws.

Installation

2

Follow the instructions in this chapter during installation.

2.1	Ambient storage conditions.....	2-2
2.2	Ambient installation conditions.....	2-2
2.3	Mounting direction and space.....	2-3
2.4	The use and installation of the servo screwdriver.....	2-4
2.5	Dimensions	2-6
2.6	Safety precautions for using the smart servo screwdriver system	2-8
2.7	Maintenance.....	2-9

2

Precautions:

The servo screwdriver controller must be properly grounded to avoid the large power supply noise causing precision error for the servo screwdriver.

2.1 Ambient storage conditions

Before installation, this product must be kept in the shipping carton. In order to retain the warranty coverage and for future maintenance, follow these instructions for storage. While the product is temporarily not in use:

- Store the product in an ambient temperature range of -20°C (-4°F) to +60°C (140°F).
- Store the product in a relative humidity range of 0% to 90% RH (non-condensing).
- Avoid storing the product in an environment containing corrosive gas.

2.2 Ambient installation conditions



Servo screwdriver system: the ambient temperature of the operating environment should be between 0°C (-32°F) to 40°C (104°F). The environment should be free of devices that generate excessive heat; no water, vapor, dust, and oily dust; no corrosive and inflammable gases or liquids; no airborne dust or metal particles; and the environment should be solid without vibration and interference of electromagnetic noise.

If the ambient temperature is over 30°C (86°F), place the product in a well-ventilated environment. During long-term operation, the suggested temperature of the operating environment should be under 25°C (77°F) to ensure the product performance.

2.3 Mounting direction and space

Precautions:

- Mount the servo screwdriver controller in the correct direction according to the following illustrations, with the controller placed flat on a desktop or vertically on a wall. Incorrect mounting direction may result in malfunction.
- For better ventilation and cooling, allow sufficient clearance space (at least 5 cm or 2 inches) between the servo screwdriver controller and the adjacent objects or walls, otherwise the overheat may result in malfunction.

2

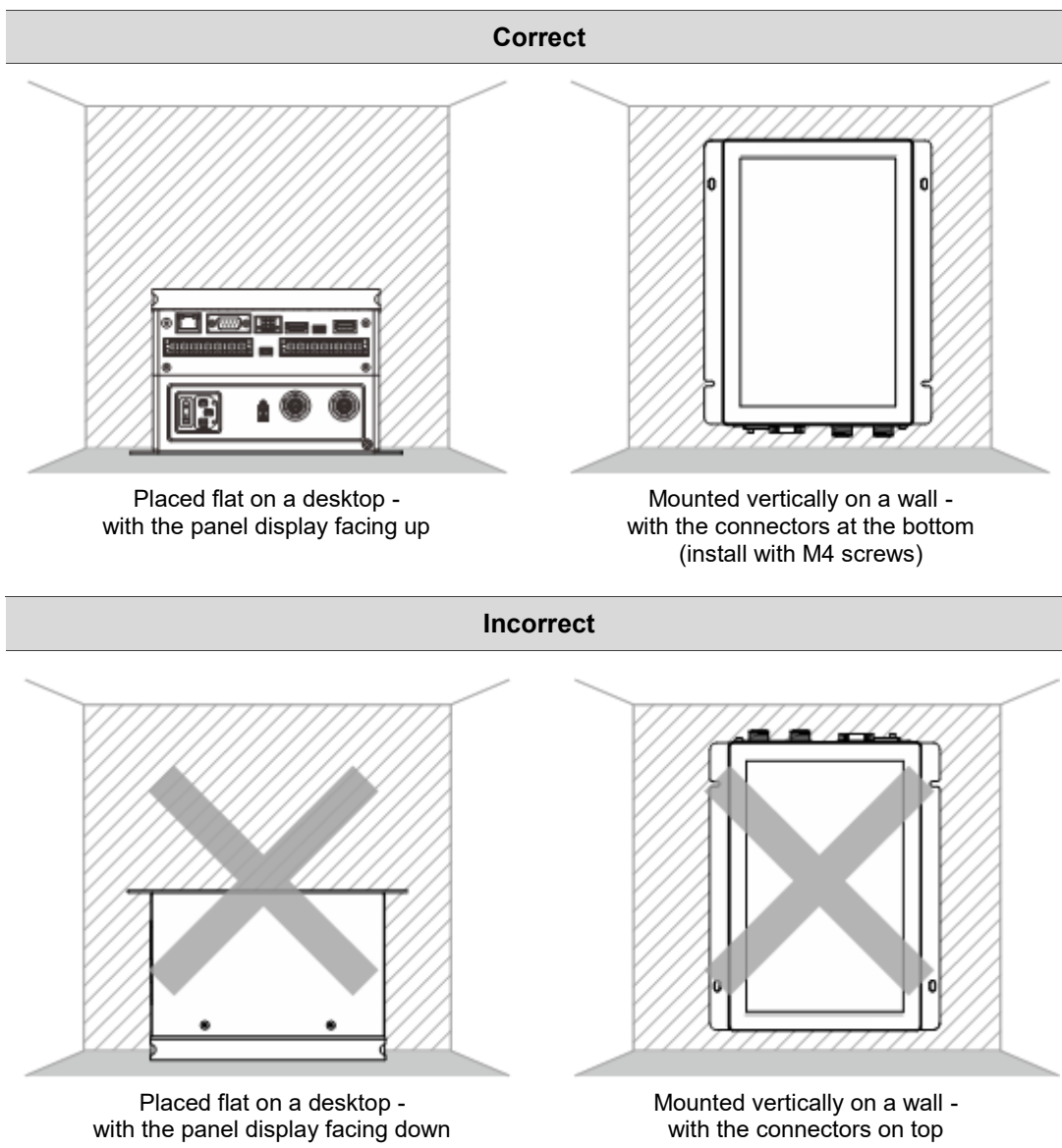

2.4 The use and installation of the servo screwdriver

The servo screwdriver can be used as a handheld or fixed device.

Installing for fixed use:

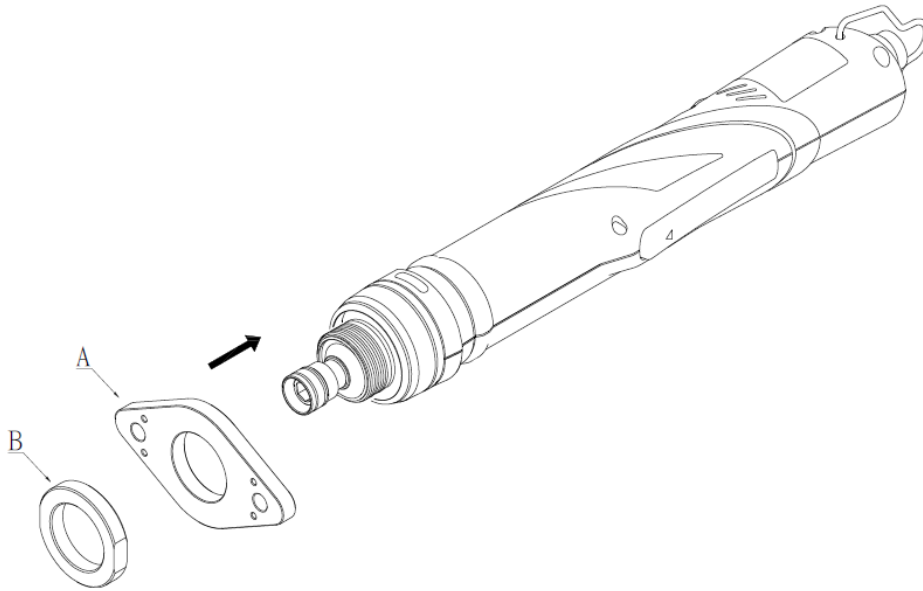

Attach the flange (A) of the flange module to the screwdriver shaft, then tighten the fixing nut (B) (55 to 60 kgf-cm). You can use the module for the screw tightening machine or robotic arm applications.

Installing the bit:

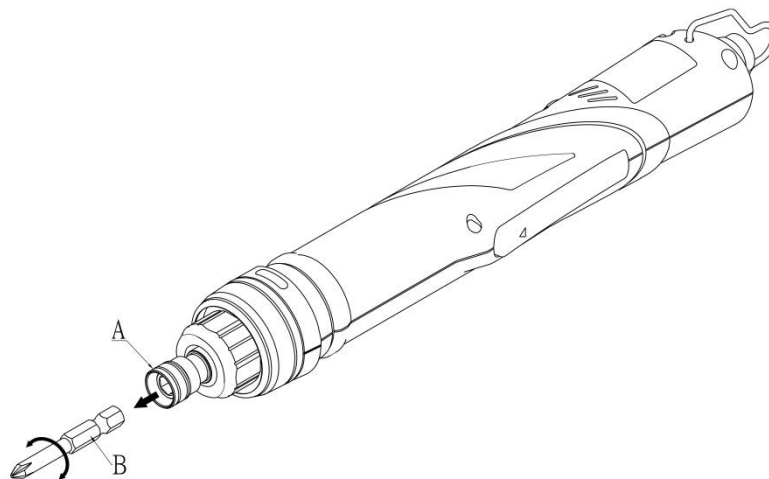

1. Pull out the collar (A).
2. Insert the bit (B).
3. If you are unable to insert the bit, rotate the bit to an angle that can be inserted.

Installing the connection cable:

The connection cable is used for connecting the servo screwdriver and the servo screwdriver controller. Note that the bending radius (r) should be no less than 60 mm (2.36 inches) when bending the cable.

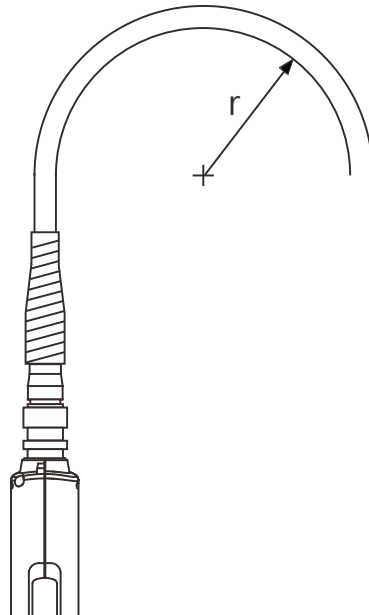

As shown in the following figure on the left, when attaching the connection cable to the servo screwdriver, align the poka-yoke bump on the cable connector with the poka-yoke bump on the screwdriver connector, then tighten the cable connector nut clockwise. While attaching, avoid impacting the pins of screwdriver connector (as shown in the following figure on the right), otherwise, it may cause the screwdriver to malfunction.

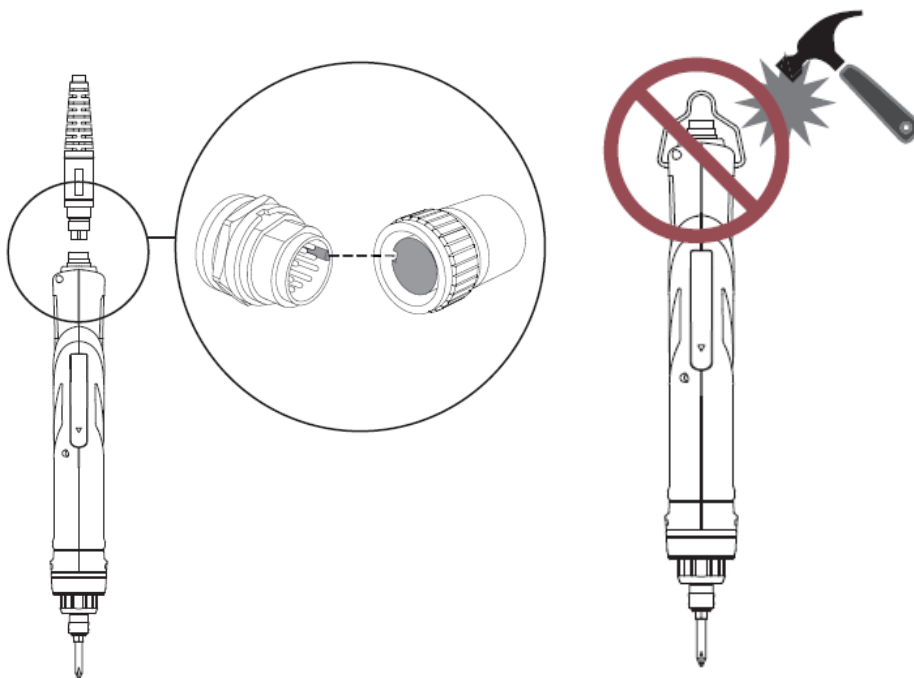

2

2.5 Dimensions

Servo screwdriver controller

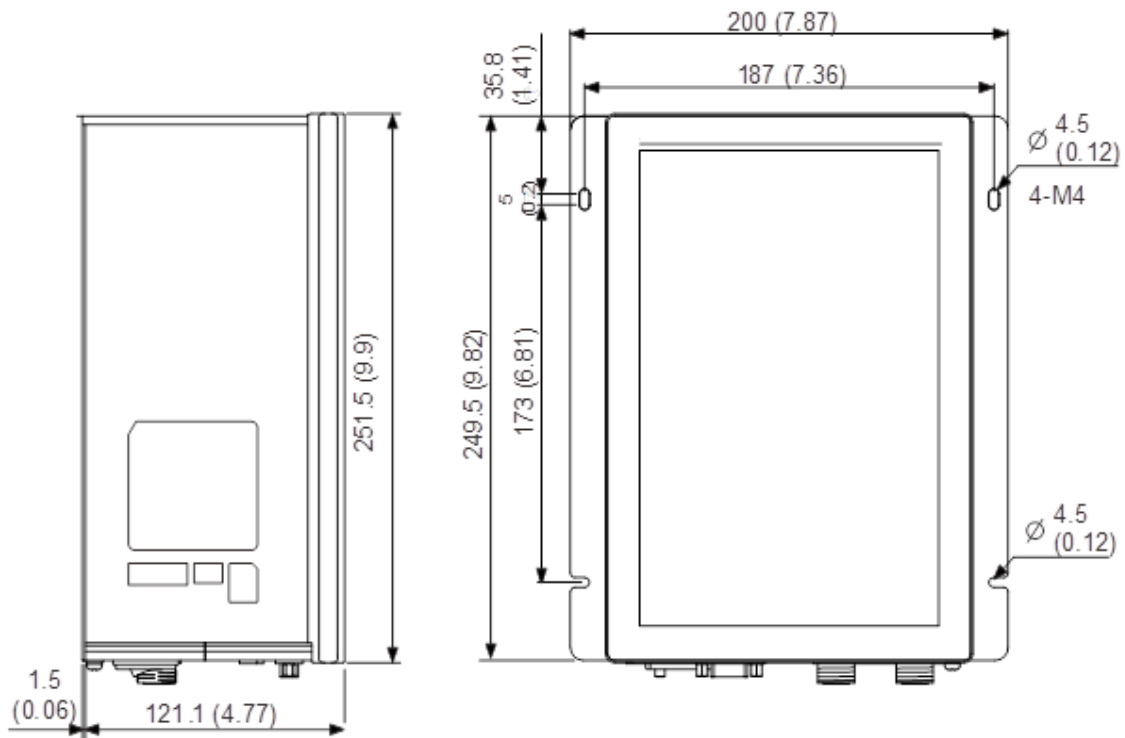

Unit: mm (inch)

Servo screwdriver

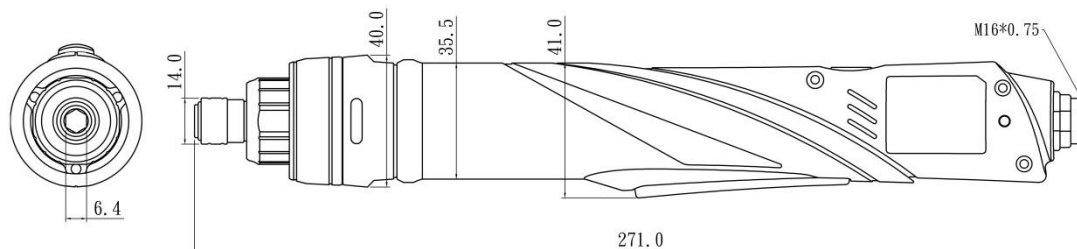

Unit: mm (inch)

Servo screwdriver (with the flange module as an optional purchase)

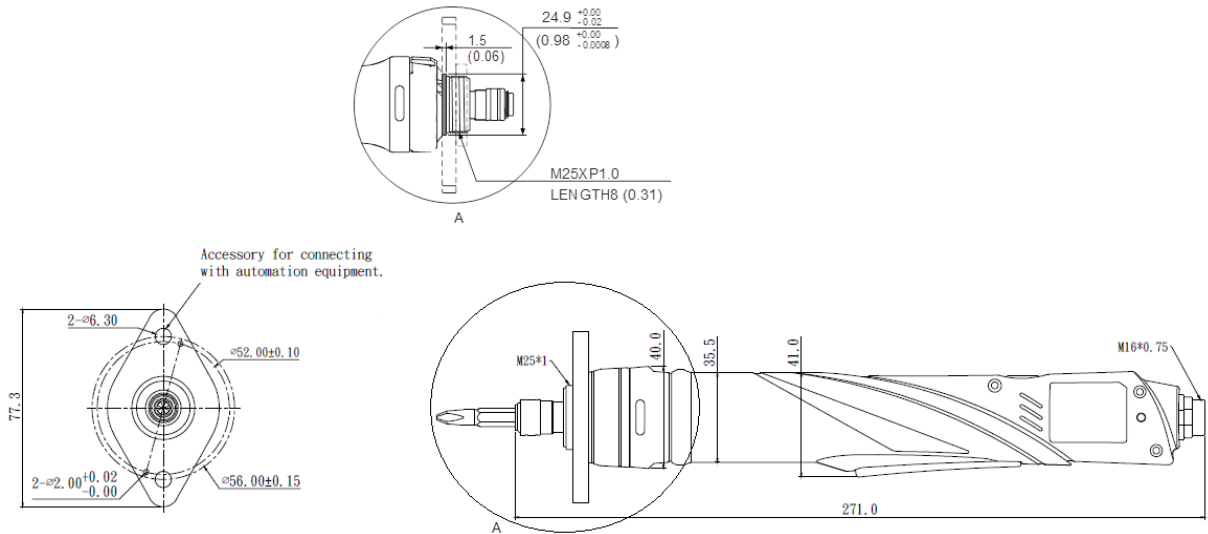

Unit: mm (inch)

Flange module (optional purchase, including the flange and fixing nut)

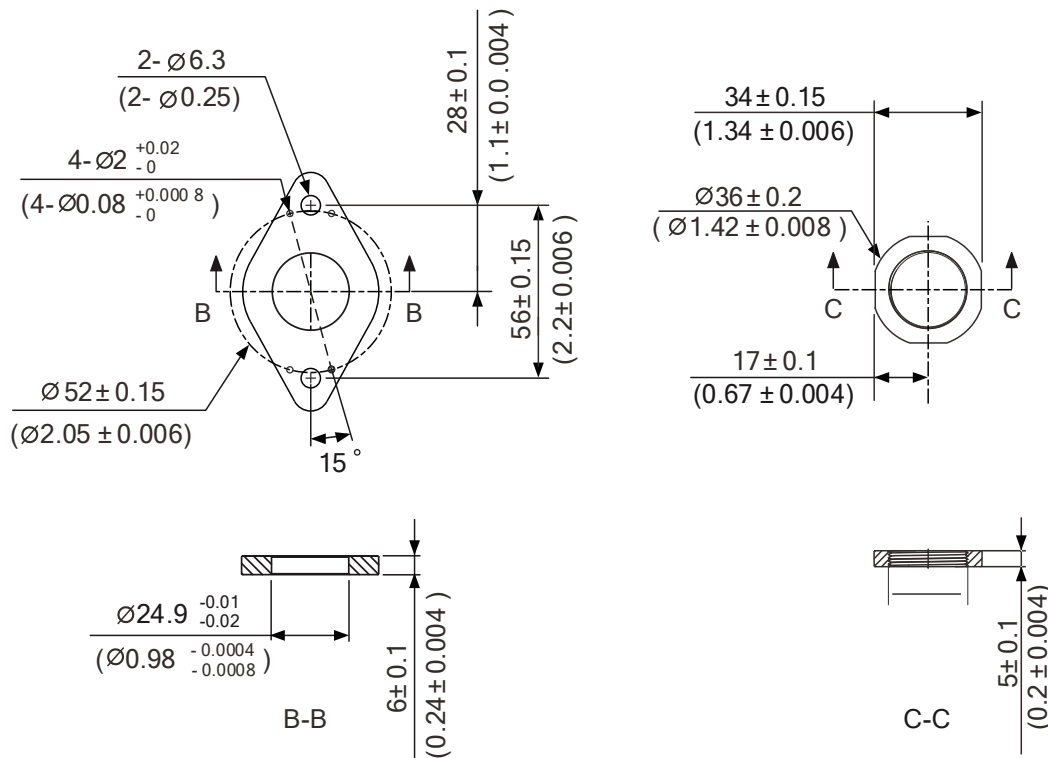

Unit: mm (inch)

2

2.6 Safety precautions

The ASA servo screwdriver system is designed for industrial applications. It is necessary that you fully understand the system specifications and operation manual. For your safety of the operator and mechanical equipment and correct use, read the manual, specifications, and precautions for the servo screwdriver system carefully before installing.

The safety precautions are as follows:

Handling, mounting, and storage

- When handling the servo screwdriver, hold the body of the screwdriver instead of only holding the cable or the shaft.
- Do not impact the shaft of the servo screwdriver. Impact force will damage the shaft and the motor attached at the rear end of the shaft.
- The shaft of the servo screwdriver is not waterproof or oil-proof. Do not use, install, or store the servo screwdriver in an environment with high humidity or contains water, oily liquids, corrosive or inflammable gases.
- The material of the servo screwdriver shaft is not rustproof. Although rustproof oil has been applied to the shaft during the manufacturing process, you must check the shaft condition and apply rustproof oil every three months if storing the motor for more than six months.
- Ensure that the environmental conditions for storing the servo screwdriver conform to the specifications written in this manual.

Operation

- The servo screwdriver operation is controlled by the servo screwdriver controller. Do not directly connect a commercial power supply (100 / 220V, 50 / 60 Hz) to the circuit of the servo screwdriver, otherwise the servo screwdriver will not operate normally and may be permanently damaged.
- Follow the specifications when using the servo screwdriver. The operation temperature of the servo screwdriver must not exceed the specified range.
- The material of the servo screwdriver shaft is not rustproof. To ensure a longer service life, apply rustproof oil during operation.
- If any odor, noise, smoke, heat, or abnormal vibration occurs during operation, stop the servo screwdriver and turn off the power immediately.
- Before replacing the servo screwdriver or the connection cable, be sure to first turn off the power of the servo screwdriver controller. Otherwise, it may damage the servo screwdriver or the connection cable.
- Keep the operating environment clean and tidy to prevent difficulty in operating the servo screwdriver or servo screwdriver controller.

- The connection cable must be properly connected and fixed to avoid cable damage from entangling or tripping hazard from loose cables.
- Wear safety goggles when using electric assembly tools.

Others

- Do not use the servo screwdriver, connection cable, or servo screwdriver controller for purposes other than those specified in this manual. Illegal or improper use may cause personal injury or damage the product and its parts. It will also void the warranty.
- Do not disassemble or attempt to repair the servo screwdriver controller, servo screwdriver or their parts without authorization, otherwise it may cause personal injury and will void the warranty.

2.7 Maintenance

The recommended maintenance cycle and maintenance measures of the servo screwdriver system under normal use are as follows:

Maintenance cycle	Maintenance measures
Every 250,000 Tightening + Loosening count or one year of use	Precision calibration and maintenance
Every 1,000,000 Tightening + Loosening count	It is recommended to send the servo screwdriver system back to the distributor or ASA for maintenance and repair

(This page is intentionally left blank.)

2

Wiring

3

This chapter illustrates the power supply circuit, connectors, and the wiring method of the ASA Tools smart servo screwdriver system.

3.1	System connection	3-2
3.1.1	Connection diagrams	3-2
3.2	Wiring for I/O connector	3-3
3.2.1	I/O connector.....	3-3
3.2.2	Signal explanation for I/O connector	3-5
3.2.3	Wiring diagrams	3-6
3.3	RS232	3-8
3.4	RS485 (used for extension)	3-9

3.1 System connection

3.1.1 Connection diagrams

3

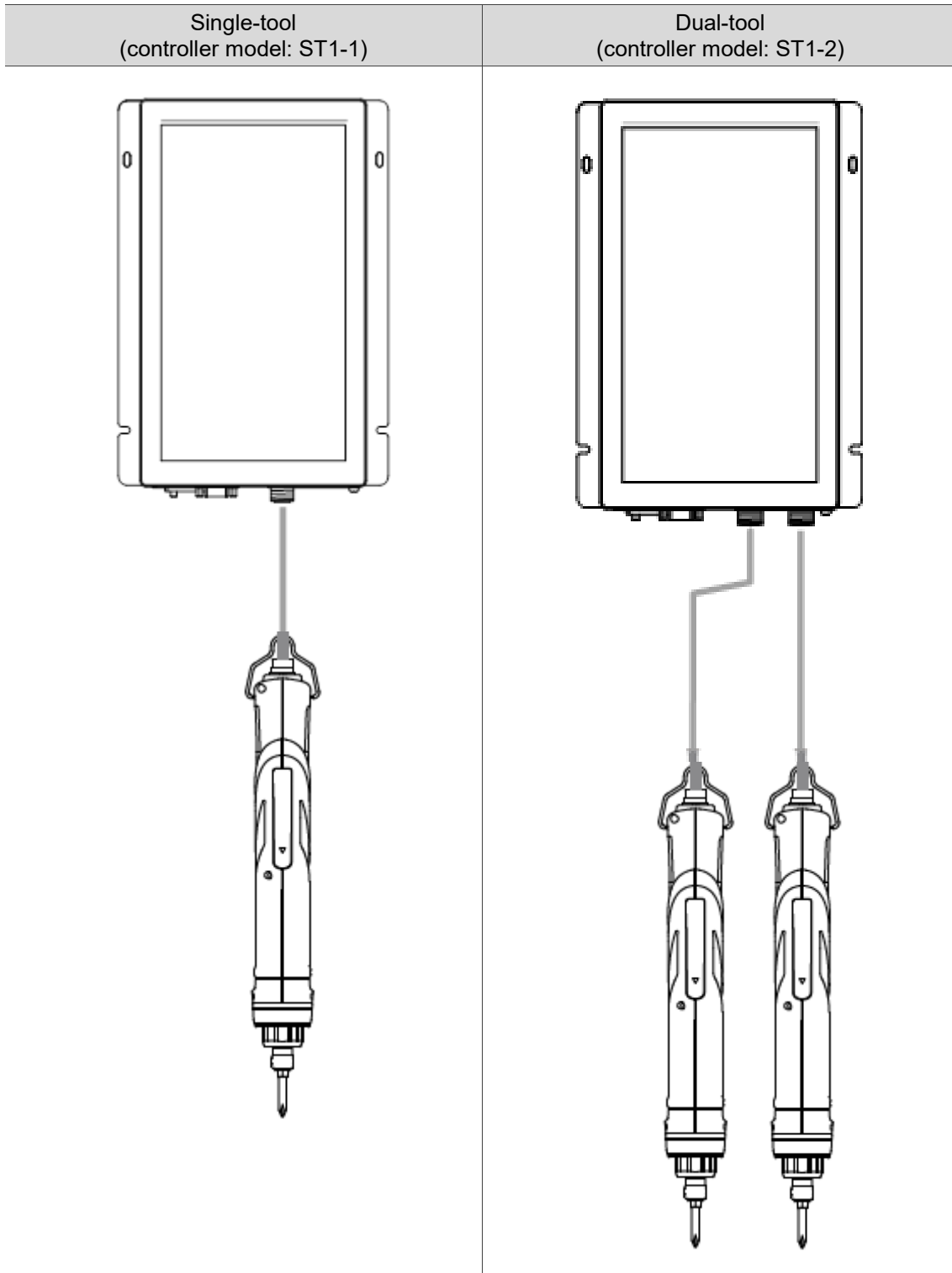

Installation precautions:

1. Make sure that the power supply and wiring (using M16 8-pin connection cables) are correct.
2. When an alarm occurs or when in emergency stop, press the switch next to the AC power connector on the servo screwdriver controller to power off the controller and the screwdriver.

3.2 Wiring for I/O connector

3.2.1 I/O connector

You can define 8 digital inputs (DI) and 8 digital outputs (DO) for each tool to achieve highly flexible communication between the host system and the servo screwdriver controller. Refer to Section 3.2.3 for details. The pin assignments for the controller are shown as follows:

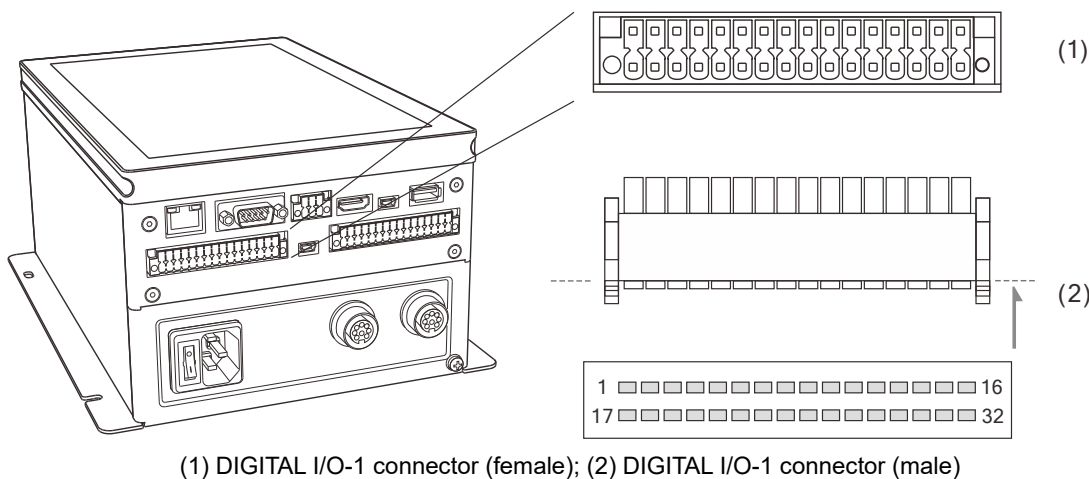

Pin assignment:

Pin	Signal	Description	Pin	Signal	Description
1	DO_24V_A	Power output (+) (24V ± 10%)	17	NC	N/A*
2	DO_A1+	Digital output (+)	18	DO_A8+	Digital output (+)
3	DO_A1-	Digital output (-)	19	DO_A8-	Digital output (-)
4	DO_A2+	Digital output (+)	20	DI_A1	Digital input
5	DO_A2-	Digital output (-)	21	DI_A2	Digital input
6	DO_A3+	Digital output (+)	22	DI_A3	Digital input
7	DO_A3-	Digital output (-)	23	DI_A4	Digital input
8	DO_A4+	Digital output (+)	24	DI_A5	Digital input
9	DO_A4-	Digital output (-)	25	DI_A6	Digital input
10	DO_A5+	Digital output (+)	26	COM_A+	Common pins for reference of DI_A1 to DI_A6
11	DO_A5-	Digital output (-)	27	DI_A7+	Digital input (+)
12	DO_A6+	Digital output (+)	28	DI_A7-	Digital input (-)
13	DO_A6-	Digital output (-)	29	DI_A8+	Digital input (+)
14	DO_A7+	Digital output (+)	30	DI_A8-	Digital input (-)
15	DO_A7-	Digital output (-)	31	NC	N/A*
16	NC	N/A*	32	PGND	Power output (-) (24V ± 10% ground)

Note:

1. N/A indicates that this terminal is for internal use only. Do not connect, or it may damage the controller.
2. You can connect the wires of the bit selector to Pin 20 - 25 and 27 - 30, refer to Section 9.2 and 9.3 for its settings.

3

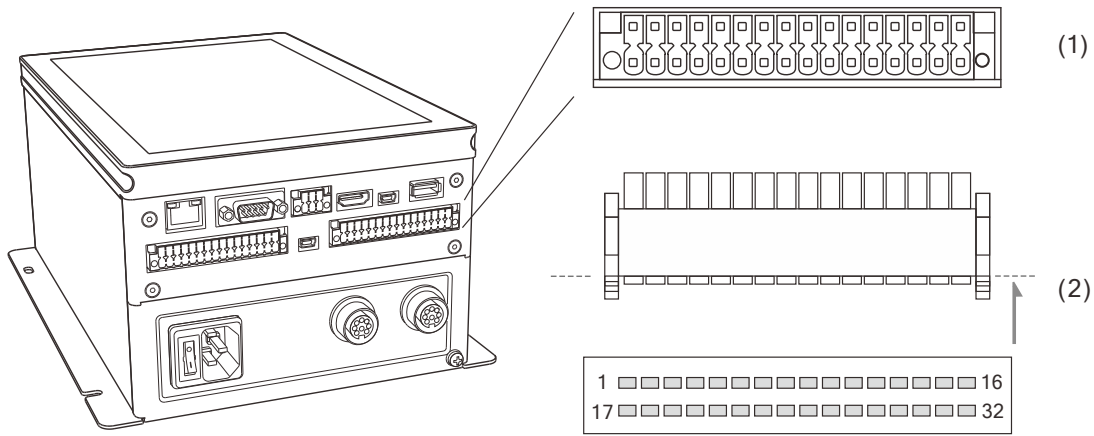

(1) DIGITAL I/O-2 connector (female); (2) DIGITAL I/O-2 connector (male)

Pin assignment:

Pin	Signal	Description	Pin	Signal	Description
1	DO_24V_B	Power output (+) (24V ± 10%)	17	NC	N/A*
2	DO_B1+	Digital output (+)	18	DO_B8+	Digital output (+)
3	DO_B1-	Digital output (-)	19	DO_B8-	Digital output (-)
4	DO_B2+	Digital output (+)	20	DI_B1	Digital input
5	DO_B2-	Digital output (-)	21	DI_B2	Digital input
6	DO_B3+	Digital output (+)	22	DI_B3	Digital input
7	DO_B3-	Digital output (-)	23	DI_B4	Digital input
8	DO_B4+	Digital output (+)	24	DI_B5	Digital input
9	DO_B4-	Digital output (-)	25	DI_B6	Digital input
10	DO_B5+	Digital output (+)	26	COM_B+	Common pins for reference of DI_B1 to DI_B6
11	DO_B5-	Digital output (-)	27	DI_B7+	Digital input (+)
12	DO_B6+	Digital output (+)	28	DI_B7-	Digital input (-)
13	DO_B6-	Digital output (-)	29	DI_B8+	Digital input (+)
14	DO_B7+	Digital output (+)	30	DI_B8-	Digital input (-)
15	DO_B7-	Digital output (-)	31	PGND	Power output (-) (24V ± 10% ground)
16	NC	N/A*	32	PGND	Power output (-) (24V ± 10% ground)

Note:

1. N/A indicates that this terminal is for internal use only. Do not connect, or it may damage the controller.
2. The bit selector can be assigned to Pin 20 - 25 and 27 - 30, refer to Section 9.2 and 9.3 for its settings.

3.2.2 Signal explanation for I/O connector

The signals listed in the previous section are described in the following table in detail.

General signals:

Signal		Pin	Description	Wiring method (refer to Section 3.2.3)
DI	DI_A1 to A6	DIGITAL I/O-1 20, 21, 22, 23, 24, 25	Both NPN and PNP wiring can be used. (must use with COM_A+). DI_A1 to A6 are for power input. Must use external power supply (24V ± 10%).	C3 / C4
	DI_B1 to B6	DIGITAL I/O-2 20, 21, 22, 23, 24, 25	Both NPN and PNP wiring can be used. (must use with COM_B+). DI_B1 to B6 are for power input. Must use external power supply (24V ± 10%).	C3 / C4
	DI_A7+ DI_A7-	DIGITAL I/O-1 27, 28	NPN: DI_A7+ / A8+ / B7+ / B8+ are for power input. Must use external power supply (24V ± 10%).	C5 / C6
	DI_A8+ DI_A8-	DIGITAL I/O-1 29, 30	DI_A7- / A8- / B7- / B8- are for power input reference connections. Must be connected to the positive (+) terminal of the external power supply (24V ± 10%).	
	DI_B7+ DI_B7-	DIGITAL I/O-2 27, 28	PNP: DI_A7+ / A8+ / B7+ / B8+ are for power input. Must use external power supply (24V ± 10%).	
	DI_B8+ DI_B8-	DIGITAL I/O-2 29, 30	DI_A7- / A8- / B7- / B8- are for power input reference connections. Must be connected to the negative (-) terminal of the external power supply (24V ± 10%).	
DO	DO_A1+ to A8+ DO_A1- to A8- DO_B1+ to B8+ DO_B1- to B8-	DIGITAL I/O-1 2 to 15, 18, 19 DIGITAL I/O-2 2 to 15, 18, 19	Perform wiring based on the load capacities. Must use external power supply (24V ± 10%).	C1 / C2
Power	COM_A+ COM_B+	DIGITAL I/O-1 26 DIGITAL I/O-2 26	NPN: COM_A+ / COM_B+ are common pins for voltage input reference of DI_A1 to A6 / DI_B1 to B6. Must be connected to the positive (+) terminal of the external power supply (24V ± 10%). PNP: COM_A+ / COM_B+ are common pins for voltage input reference of DI_A1 to A6 / DI_B1 to B6. Must be connected to the negative (-) terminal of the external power supply (24V ± 10%).	-
	DO_24V_A DO_24V_B	DIGITAL I/O-1 1 DIGITAL I/O-2 1	Power output (+) (24V ± 10%)	
	PGND	DIGITAL I/O-1 32 DIGITAL I/O-2 31, 32	Power output (-) (24V ± 10% ground)	
Other	NC	DIGITAL I/O-1 16, 17, 31 DIGITAL I/O-2 16, 17	N/A; these terminals are for internal use only. Do not connect to NC, or it may damage the controller.	-

3

3.2.3 Wiring diagrams

DO wiring:

C1: external power supply, general load

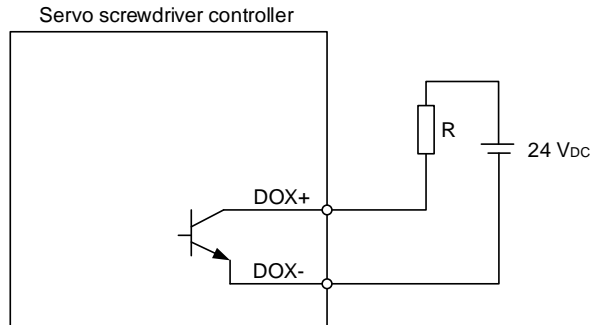

C2: external power supply, inductive load

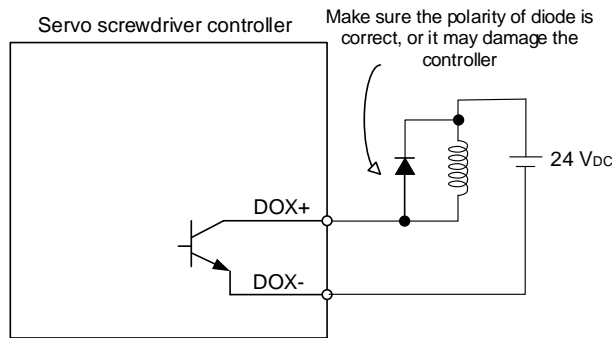

DI wiring: input signals by relay or open collector transistor.

Conditions of DI On / Off:

ON: 15V - 24V; condition: input current = 8 mA

OFF: 5V or lower; condition: input current must not be higher than 0.5 mA

C3: NPN transistor, SINK mode (DI_A1 to A6, DI_B1 to B6)

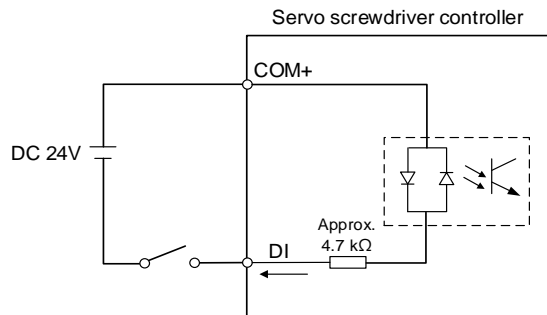

C4: PNP transistor, SOURCE mode (DI_A1 to A6, DI_B1 to B6)

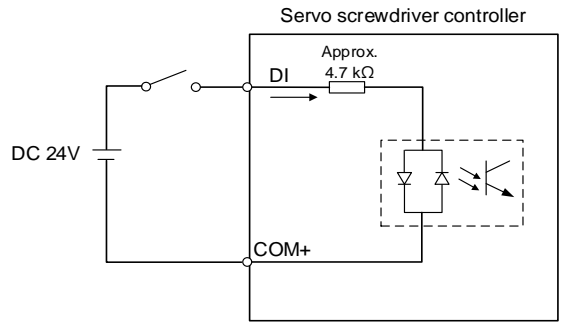

C5: NPN transistor, SINK mode, without sharing a COM+ for input (DI_A7 / A8 / B7 / B8)

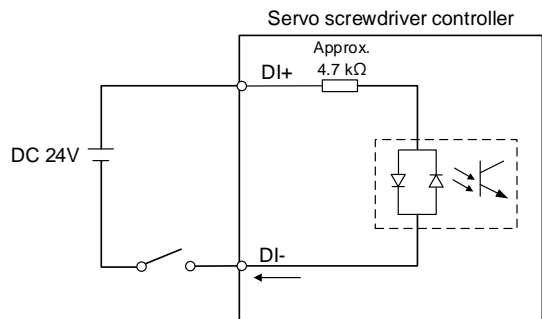

C6: PNP transistor, SOURCE mode, without sharing a COM+ for input (DI_A7 / A8 / B7 / B8)

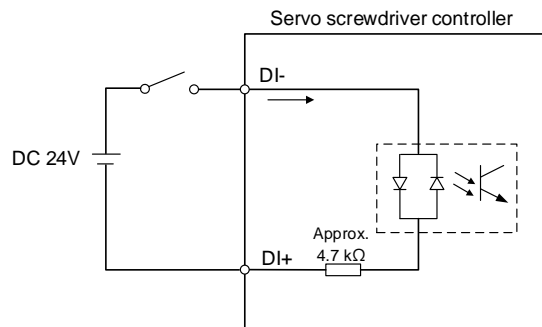

3

3.3 RS232

Through the RS232 port, you can connect a barcode scanner with RS232 interface to the servo screwdriver controller in order to scan the barcode and identify the tightening parameters or sequence to be executed.

Pin assignment:

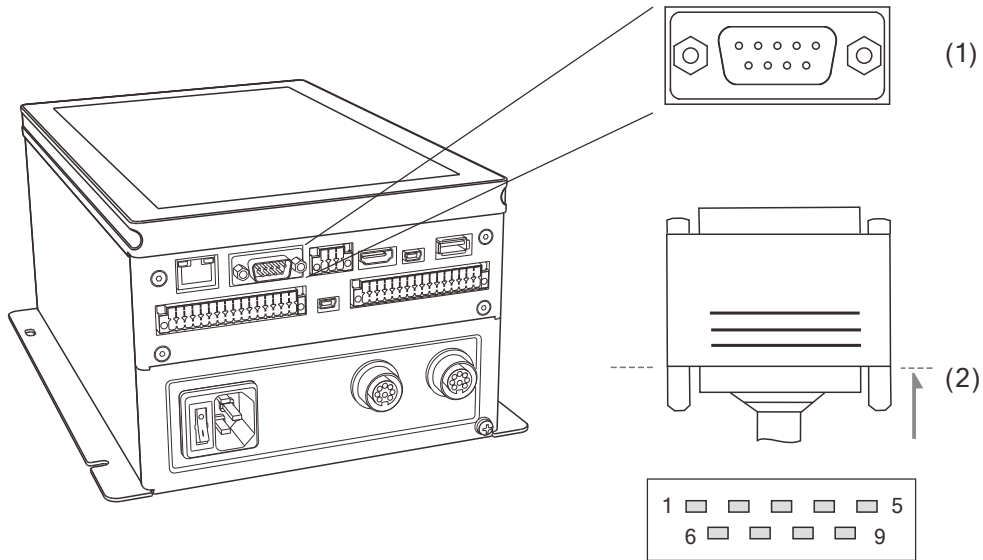

(1) RS232 connector (female); (2) RS232 connector (male)

Pin	Description
1	-
2	RXD
3	TXD
4	-
5	GND
6	-
7	RTS
8	CTS
9	-

3.4 RS485 (used for extension)

You can connect the equipment with RS485 communication interface (such as PLC) to the servo screwdriver controller through the RS485 port.

There are 2 signal pairs for RS485. The first pair is Pin 1 and Pin 4, and the second pair is Pin 3 and Pin 6.

Pin assignment:

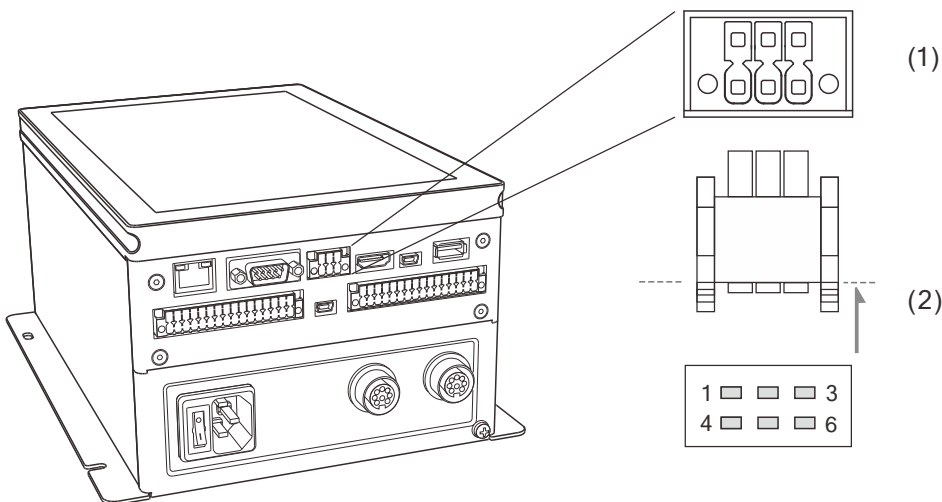

(1) RS485 connector (female); (2) RS485 connector (male)

Pin	Signal	Description	Pin	Signal	Description
1	D1-	Tx- / Rx-	4	D1+	Tx+ / Rx+
2	GND	-	5	NC	N/A*
3	D2-	Tx- / Rx-	6	D2+	Tx+ / Rx+

Note: N/A indicates that this terminal is for internal use only. Do not connect, or it may damage the controller.

(This page is intentionally left blank.)

3

Functions Overview

4

This chapter introduces the major functions of the smart servo screwdriver system.



- 4.1 Functions overview 4-2
 - 4.1.1 Major functions 4-3

4.1 Functions overview

There are eight major functions on the main screen of the servo screwdriver system:
Parameters, Sequence, Sources, Results, Controller, Tool, Reports, and Help.

4



4.1.1 Major functions

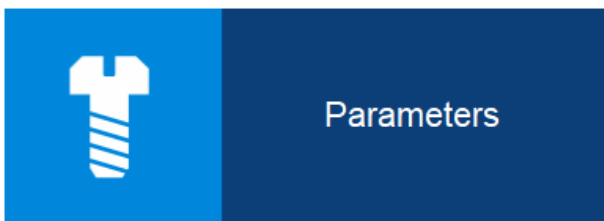

Parameters: create the screw tightening strategies. Customize different tightening strategies for different tightening requirements.

The strategies include: Standard, Enhanced, Pre-position, and Self-defined.



Sequence: create the screw tightening sequences. Arrange the tightening sequence for products when needed.

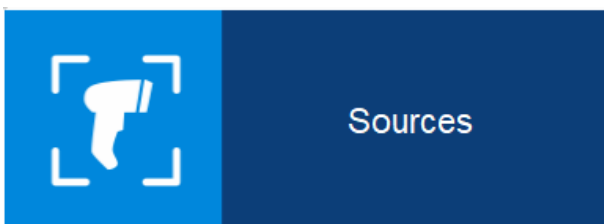

Sources: specify the operating mode of the system, and create settings to automatically switch to the corresponding parameter or sequence with the screw bit selector or the barcode scanner.

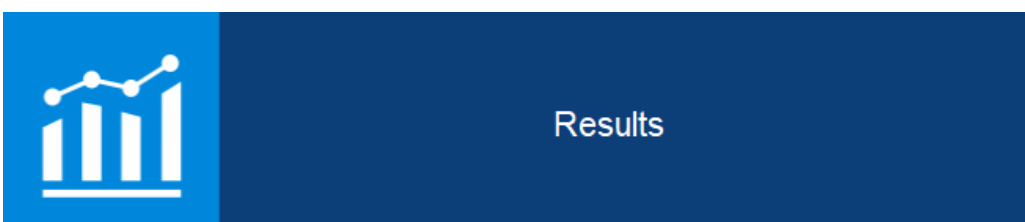

Results: obtain the operational status of each tightening, including the screw progress, total screw quantity that have been tightened, current parameter title, tightening status, and curve.

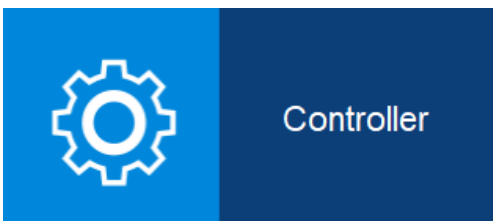

Controller: configure or access the system-related settings, including the controller firmware version, screen settings, DI/DO functions, and peripheral device settings.

4



Tool: configure or access the servo screwdriver settings and information, including model name and specifications, LED light settings, and tool calibration.



Reports: access the records of all operational statuses, including production reports, error reports and warning reports.



Help: obtain operational support documents.

Parameters (Tightening parameters)

5

This chapter introduces the functions of tightening parameters. You can customize different tightening parameters for different tightening scenarios to achieve the quality requirements of products. Create various screw tightening strategies to easily switch between strategies in the servo screwdriver system.

5.1	Parameters overview	5-2
5.2	Create parameters	5-3
5.3	Tightening strategies and the Settings tabs	5-6
5.3.1	General settings	5-7
5.3.2	Tightening settings	5-8
5.3.2.1	Standard strategy	5-8
5.3.2.2	Enhanced strategy	5-14
5.3.2.3	Pre-position strategy	5-15
5.3.2.4	Self-defined strategy	5-17
5.3.3	Loosening settings	5-21
5.4	Save parameters	5-22
5.5	Copy and paste parameters	5-22
5.6	Delete parameters	5-24
5.7	Import / export parameters	5-25

5

5.1 Parameters overview

Create different tightening strategies according to the specifications of each servo screwdriver. Up to 500 sets of parameters can be created for a single tool. Each row in the parameters list (shown as follows) represents one set of parameter.

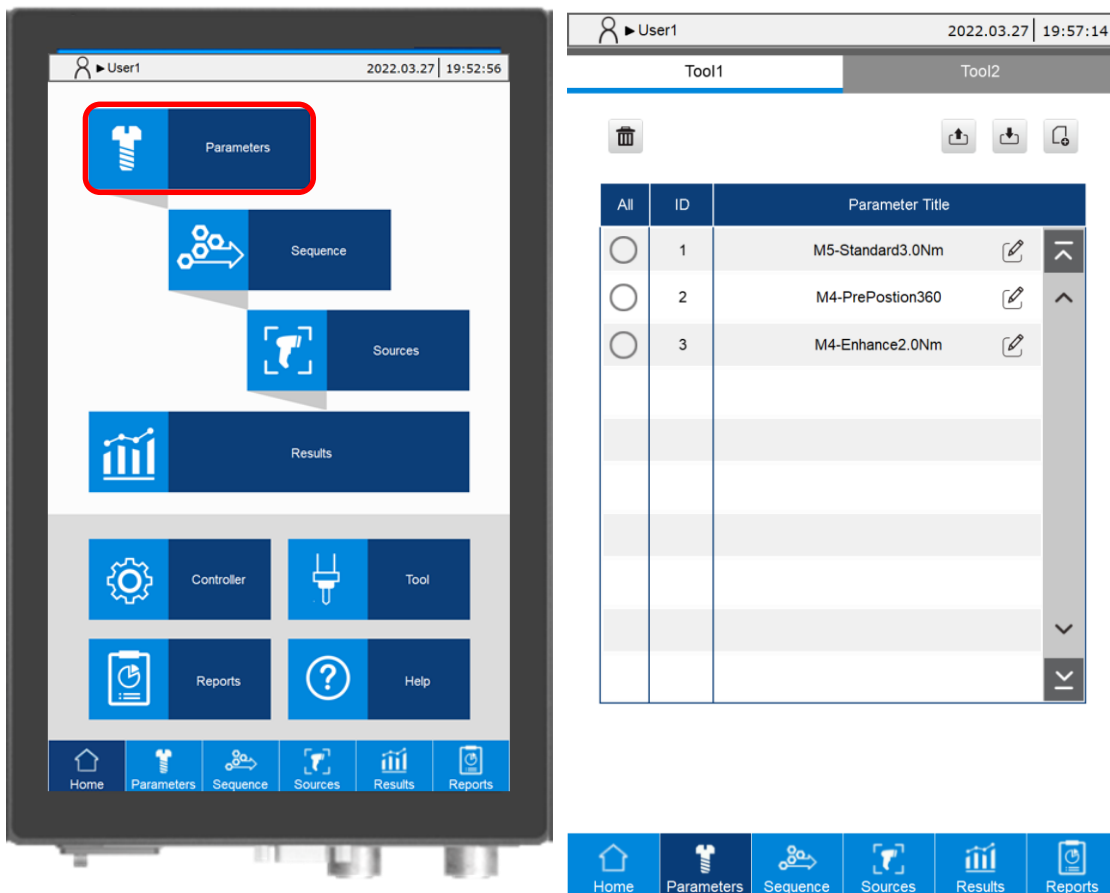

5.2 Create parameters

Click  to create a set of parameter. After creation, the parameter ID and Parameter Title are displayed. You can create parameters with Quick Start (default) or General Start.

5

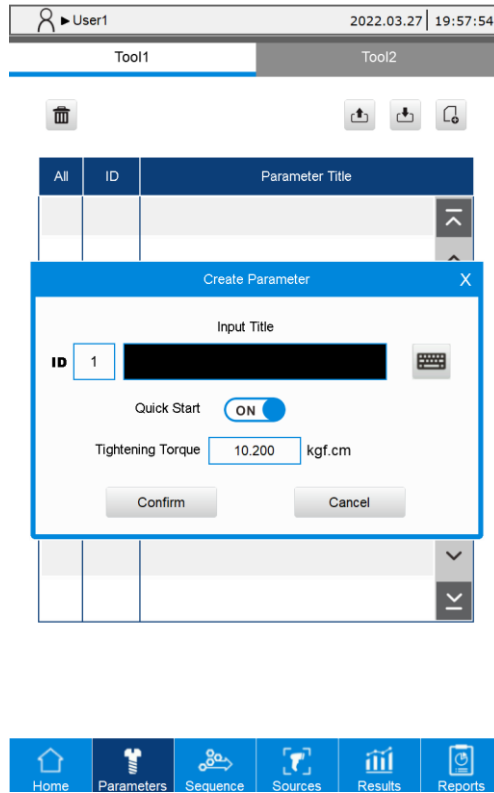

Quick start:

Step 1: input the parameter title.

Step 2: input the final Tightening Torque and press **Confirm** to create the parameter.

Default values are applied to the remaining parameter settings.

5

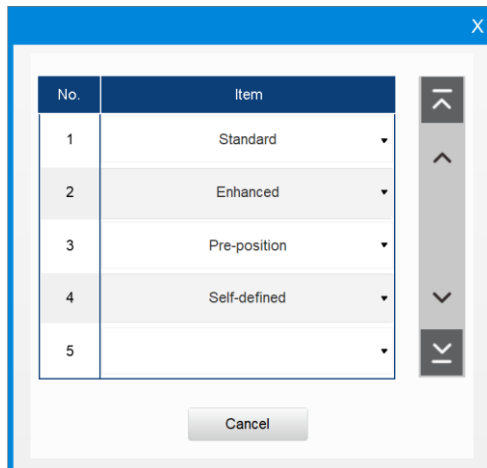
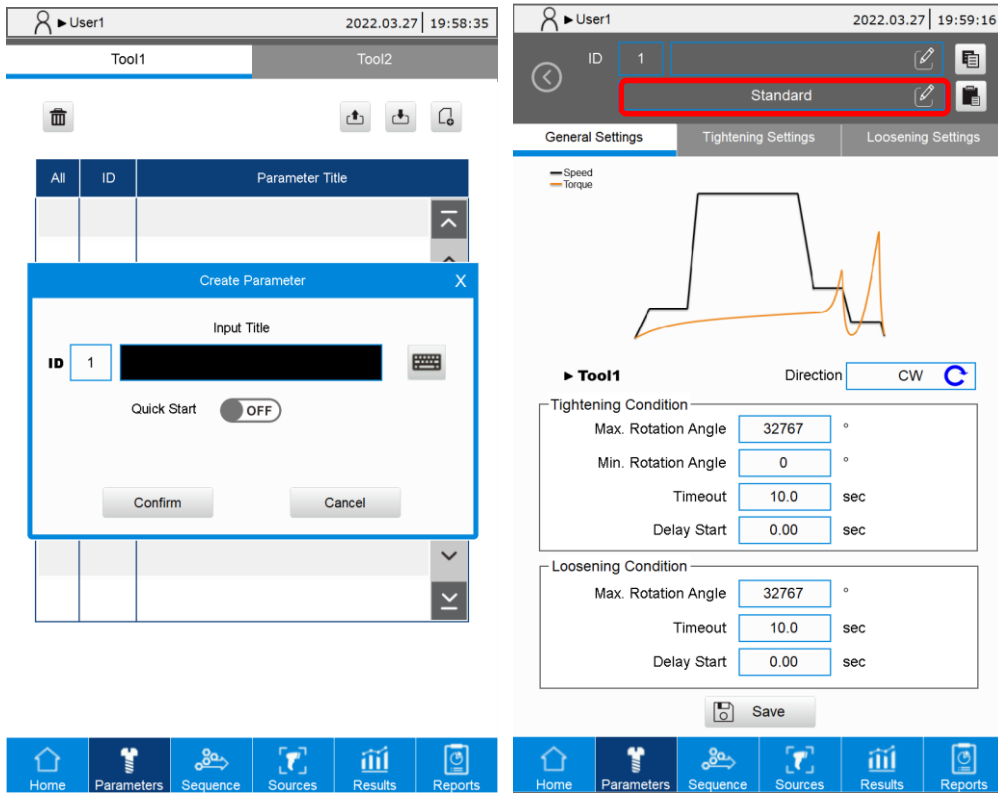

General start:

Step 1: input the parameter title.

Step 2: disable the "Quick Start" option and press **Confirm**. The parameter editing page is then opened.

Step 3: select a tightening strategy. The options include Standard, Enhanced, Pre-position, and Self-defined.

Step 4: set the contents of General Settings, Tightening Settings and Loosening Settings in sequence.

Step 5: after completing the setting, click **Save**.

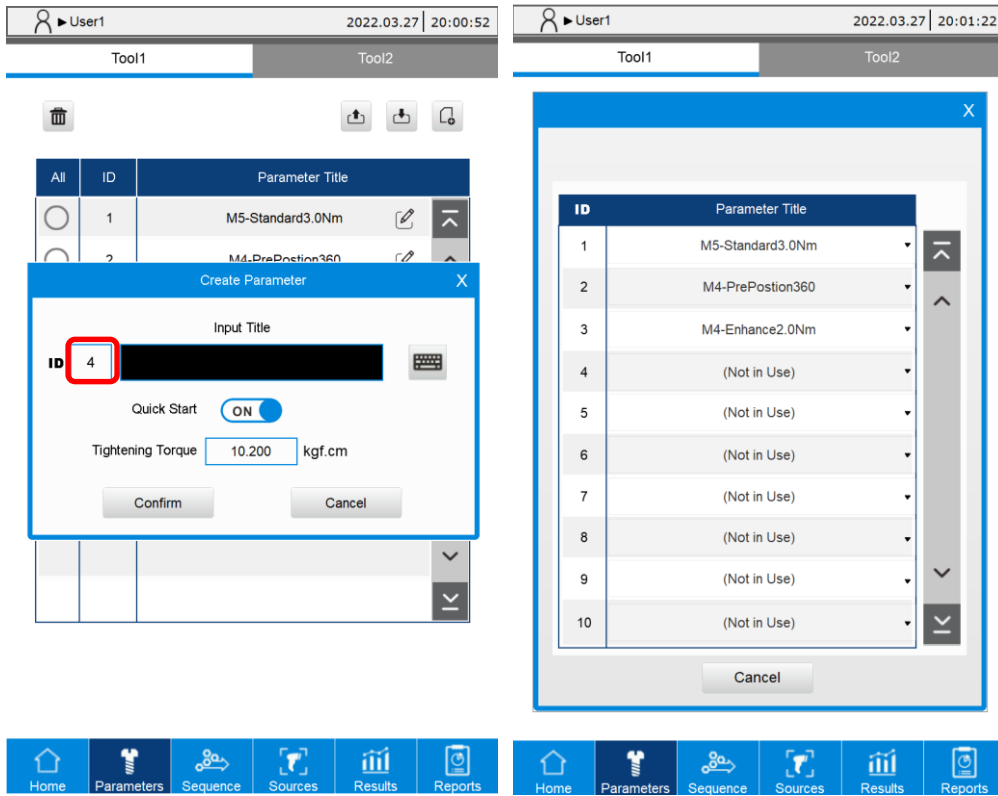

When you click  to create a parameter, the system searches for a parameter ID that has not yet been used, and automatically sets that ID as the new parameter ID. If you want to assign a specific ID, click the ID field in the Create Parameter window to choose the desired ID for the new parameter.

5.3 Tightening strategies and the Settings tabs

Use different tightening strategies to customize the tightening process based on different needs.

The system provides four tightening strategies:

1. Standard: there are four stages in the tightening process, including Start, Rundown, Pre-tightening, and Tightening. The parameters of each stage can be adjusted individually to achieve optimized tightening results.
2. Enhanced: execute re-tightening with the Tightening stage from the Standard tightening strategy.
3. Pre-position: tighten the screw to a specific angle with the Start and Rundown stages from the Standard tightening strategy.
4. Self-defined: arrange the tightening process as needed, you can set a maximum of six stages.

Refer to the following table to select the tightening strategy applicable for your tightening requirements.

Common tightening strategies:

Stage	Start	Rundown	Pre-tightening	Tightening
Standard	Start angle	Rundown angle Rundown torque Torque rate	Pre-tightening torque	Target torque Target angle
Enhanced	-	-	-	Target torque Target angle
Pre-position	Start angle	Rundown torque Rundown angle Torque rate	-	-

You can use self-defined strategies for special scenarios:

Stage	Stage 1	Stage 2	Stage 3	Stage 4	Stage 5	Stage 6
Self-defined	Angle Torque Torque rate	Angle Torque Torque rate	Angle Torque Torque rate	Angle Torque Torque rate	Angle Torque Torque rate	Angle Torque Torque rate

Each strategy contains three setting tabs: General Settings, Tightening Settings, and Loosening Settings. The following illustrates the setting screens of the three tabs under different tightening strategies.

5.3.1 General settings

The screens of General Settings for all tightening strategies are the same (only the curve graphs are different). In this section, the General Settings screen of Standard strategy is used as an example.

The general tightening and loosening conditions can be set in the General Settings screen.

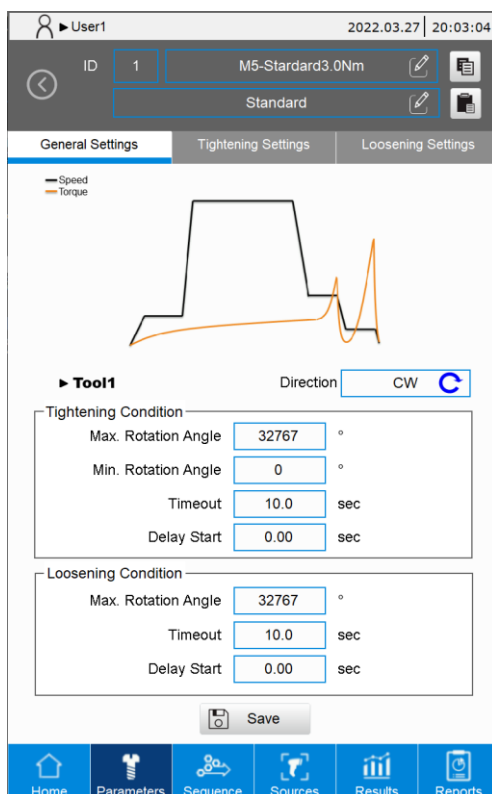

1. Tool 1 / Tool 2: the tool ID for the currently displayed settings.
2. Direction: the rotation direction of the tool.
3. Tightening Condition:
 - (1) Max. Rotation Angle: set the maximum rotation angle of tightening (1 turn = 360°).
When to use: for checking whether the screw length is suitable.
 - (2) Min. Rotation Angle: set the minimum rotation angle of tightening (1 turn = 360°).
When to use: for checking whether the screw is underdriven.
 - (3) Timeout: limit the total time of the tightening process.
 - (4) Delay Start: the delay time before the tightening starts.
4. Loosening Condition:
 - (1) Max. Rotation Angle: set the maximum rotation angle of loosening (1 turn = 360°).
 - (2) Timeout: limit the total time of the loosening process.
 - (3) Delay Start: the delay time before the loosening starts.

5.3.2 Tightening settings

5.3.2.1. Standard strategy

There are four stages in the Standard strategy, including Start, Rundown, Pre-tightening, and Tightening.

A. Start: tighten the screw slowly to make sure it aligns with the screw hole.

The screenshot displays the 'Tightening Settings' for the 'Start' stage. The main interface includes a graph showing Speed (black line) and Torque (orange line) profiles. Below the graph, the 'Start' stage is selected, with the following parameters:

- Angle: 90 °
- Speed: 80 rpm
- Max. Torque: 10.200 kgf.cm (with an ON/OFF toggle)
- Min. Torque: 0.000 kgf.cm

An 'Advanced Setting' dialog box is open, showing the following parameters:

- Max. Operation Time: OFF (sec)
- Min. Operation Time: OFF (sec)
- Acc. Time: 30 ms

(1) Angle: after the tool operates to the set angle, the system switches to the Rundown stage. The recommended angle is 90° to 360°.

(0: skip the Start stage and automatically switch to the Rundown stage).

(2) Speed: the speed should not be set too high; the recommended speed is 80 rpm.

(3) Max. Torque: set the maximum torque of the Start stage. You can turn this function on or off.

When to use: for checking whether the screw is already tightened.

(4) Min. Torque: set the minimum torque of the Start stage. You can turn this function on or off.

When to use: for identifying whether the tool is successfully started.

Note: the torque set for this stage cannot exceed the torque set in the Tightening stage.

Start Advanced Setting:

- (1) Max. Operation Time: set the maximum operation time of the Start stage. You can turn this function on or off.
- (2) Min. Operation Time: set the minimum operation time of the Start stage. You can turn this function on or off.
- (3) Acc. Time: adjust the acceleration time for Start stage.

5

5

B. Rundown: tighten the screw quickly.

(1) There are three modes for determining whether the rundown is completed: Angle, Torque, and Torque Rate.

- Angle: after the tool operates to the set angle, the system switches to the Pre-tightening stage. For example, if the number of thread turns is 10, the rundown angle must be lower than 3600°; the recommended angle would be around 3300°.
- Torque: after the tool operates to the set torque, the system switches to the Pre-tightening stage. The recommended torque is 25% of the target torque.

Note: the rundown torque must be lower than the tightening torque, otherwise an alarm will occur when saving the parameters.

- Torque Rate: after the tool operates to the set torque rate, the system switches to the Pre-tightening stage. This can be set according to the torque rate curve as in the following figure.

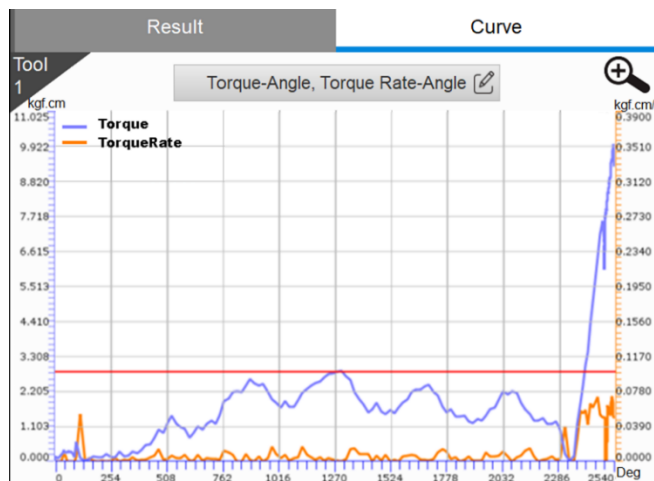

- (2) Speed: it is recommended to set the speed lower than the maximum speed allowed for the servo screwdriver; the default value is 70% of the tool max. speed.
- (3) Max. Torque: set the maximum torque of the Rundown stage. You can turn this function on or off.
When to use: the friction increases when there are foreign objects or burrs in the screw holes, which leads to excessive torque. You can limit the maximum torque by setting the max. torque.
- (4) Min. Torque: set the minimum torque of the Rundown stage. You can turn this function on or off.
Note: when under the Angle, Torque, and Torque Rate modes, the torque value set in this stage cannot exceed the torque value set in the Tightening stage.
- (5) Max. Angle: set the maximum angle of the Rundown stage. You can turn this function on or off.
- (6) Min. Angle: set the minimum angle of the Rundown stage. You can turn this function on or off.

Rundown Advanced Setting:

- (1) Max. Operation Time: set the maximum operation time for the Rundown stage. You can turn this function on or off.
- (2) Min. Operation Time: set the minimum operation time of the Rundown stage. You can turn this function on or off.
- (3) Angle Interval for Torque Rate Calculation: this function filters out the power surge during operation, but when the setting is too large, the curvature of torque rate is more likely to become distorted.
- (4) Acc. Time: adjust the acceleration time for Start stage.

C. Pre-tightening: tighten the screw head closer to the surface of the object to be tightened, and reach the certain torque requirement.

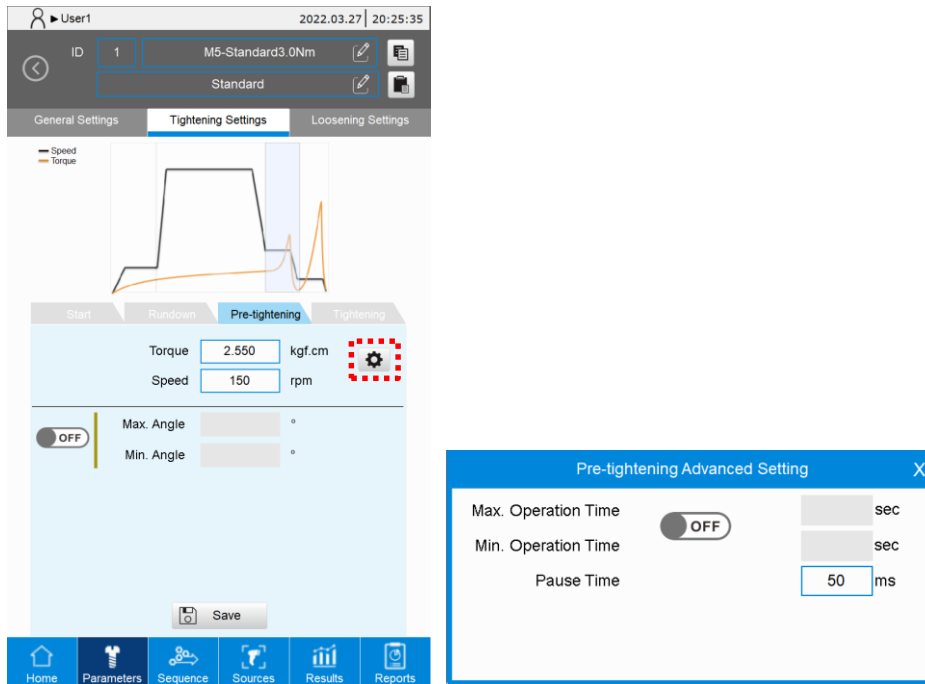

(1) Torque: after the tool operates to the set torque, the system switches to the Tightening stage. The recommended torque is 80% of the target torque.

Note: the pre-tightening torque must be lower than the tightening torque, otherwise an alarm will occur when saving the parameters.

(2) Speed: in this stage, the screw head is tightened closer to the surface of the object to be tightened. The speed should not be too high; the recommended setting is < 200 rpm.

Note: the speed set for this stage cannot exceed the speed set in the Tightening stage.

(3) Max. Angle: set the maximum angle of the Pre-tightening stage. You can turn this function on or off.

(4) Min. Angle: set the minimum angle of the Pre-tightening stage. You can turn this function on or off.

Pre-tightening Advanced Setting:

(1) Max. Operation Time: set the maximum operation time for the Pre-tightening stage.

You can turn this function on or off.

(2) Min. Operation Time: set the minimum operation time of the Pre-tightening stage.

You can turn this function on or off.

(3) Pause Time: after the set pre-tightening torque is reached, the tool stops the operation for a period of time to release stress. The recommended setting is 50 ms.

D. Tightening: tighten at a low speed to achieve the final tightening results.

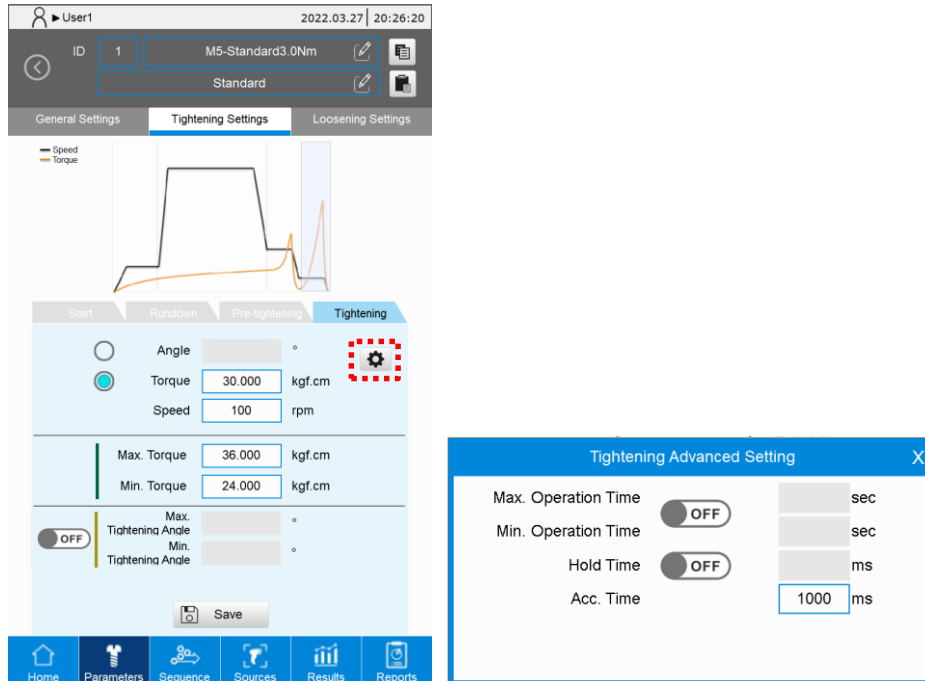

(1) There are two modes to determine whether the tightening is completed: Angle and Torque.

- Angle: after the tool operates to the set angle, the Tightening operation ends.
- Torque: after the tool operates to the set torque, the tightening operation ends.

(2) Speed: Do not set the speed too high in case the screw tightening precision is affected. The default value is 100 rpm.

(3) Max. Torque: set the maximum torque of the Tightening stage. You can turn this function on or off.

(4) Min. Torque: set the minimum torque of the Tightening stage. You can turn this function on or off.

When to use Max. Torque / Min. torque: for checking whether the tightening results meet the product requirements.

(5) Max. Tightening Angle: set the maximum angle for the Tightening stage. You can turn this function on or off.

When to use: monitor the final torque to determine whether the tightening results meet the product requirements. The final tightening angle is different according to the hardness of the material to be tightened. The softer the material, the larger the tightening angle.

(6) Min. Tightening Angle: set the minimum angle for the Tightening stage. You can turn this function on or off.

Tightening advanced setting:

(1) Max. Operation Time: set the maximum operation time for the Tightening stage. You can turn this function on or off.

5

(2) Min. Operation Time: set the minimum operation time of the Tightening stage. You can turn this function on or off.

When to use: check if the actual operation time is too short, and help determine whether the screw is underdriven.

(3) Hold Time: the duration of keeping the Servo ON state after the tightening torque is reached, which can enhance the tightening effect. The default value is 0 ms. You can turn this function on or off.

(4) Acc. Time: adjust the acceleration time for Tightening stage.

5.3.2.2. Enhanced strategy

The Tightening Settings of the Enhanced strategy only contains the Tightening stage.

The screenshot displays the 'Tightening Settings' for the 'Enhanced' strategy. The main interface includes a graph showing Speed (blue line) and Torque (orange line) over time. Below the graph, the 'Tightening' section has radio buttons for 'Angle' and 'Torque' (selected). The 'Torque' mode is active, with a speed of 100 rpm, a maximum torque of 10.710 kgf.cm, and a minimum torque of 8.160 kgf.cm. There are also fields for 'Max. Tightening Angle' and 'Min. Tightening Angle', both currently set to 'OFF'. A 'Save' button is at the bottom. An inset window titled 'Tightening Advanced Setting' shows: 'Max. Operation Time' (OFF), 'Min. Operation Time' (OFF), 'Hold Time' (OFF), and 'Acc. Time' (1000 ms).

(1) There are two modes for determining whether the tightening is complete: Angle and Torque.

- Angle: after the tool operates to the set angle, the Tightening operation ends.
- Torque: after the tool operates to the set torque, the tightening operation ends.

(2) Speed: the Enhanced strategy is for further tightening the screw, so the speed should not be too high. The default speed is 100 rpm.

For the description of other functions in this setting screen, refer to Section 5.3.2.1 for the description of the Tightening stage under Standard strategy.

5.3.2.3. Pre-position strategy

There are two stages in the Tightening Settings of Pre-position strategy: Start and Rundown.

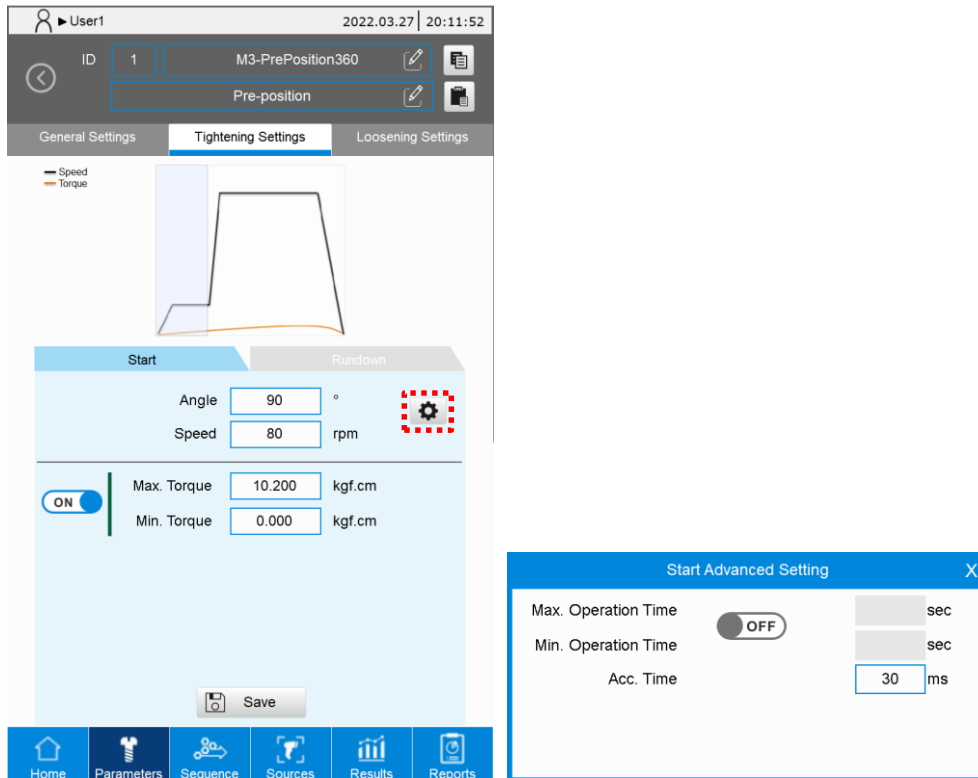

A. Start:

- (1) Angle: after the tool operates to the set angle, the system switches to the Rundown stage.
 The recommended setting is 90° to 360°
 (0: skip the Start stage and automatically switch to the Rundown stage).
- (2) Speed: this speed should not be set too high; the recommended setting is < 100 rpm.

For the description of other functions in this setting screen, refer to Section 5.3.2.1 for the description of the Start stage under Standard strategy.

5

B. Rundown:

- (1) There are three modes for determining whether the Rundown stage is completed: Angle, Torque, and Torque Rate.
 - Angle: after the tool operates to the set angle, the Rundown operation ends.
 - Torque: after the tool operates to the set torque, the Rundown operation ends.
 - Torque rate: after the tool operates to the set torque rate, the Rundown operation ends.
- (2) Speed: it is recommended to set the speed lower than the maximum speed allowed for the servo screwdriver.

For the settings of other functions in this setting screen, refer to Section 5.3.2.1 for the description of the Rundown stage under Standard strategy.

5.3.2.4. Self-defined strategy

Create your own tightening process according to different scenarios in the Tightening Settings screen under Self-defined strategy. Up to six stages can be set.

You can select different rotation directions of the tool and different control methods (Angle Control, Torque Control or Torque Rate Control) for each stage

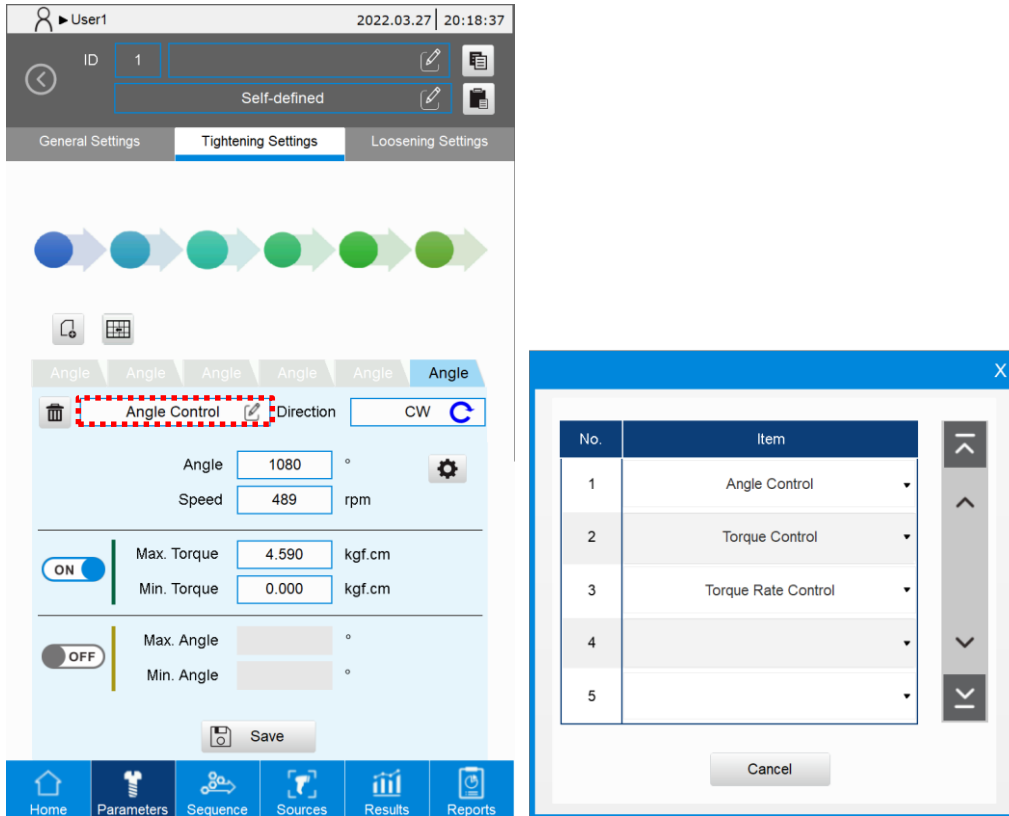

5

A. Angle Control: when tightening, the tool stops after operating to the specified angle.

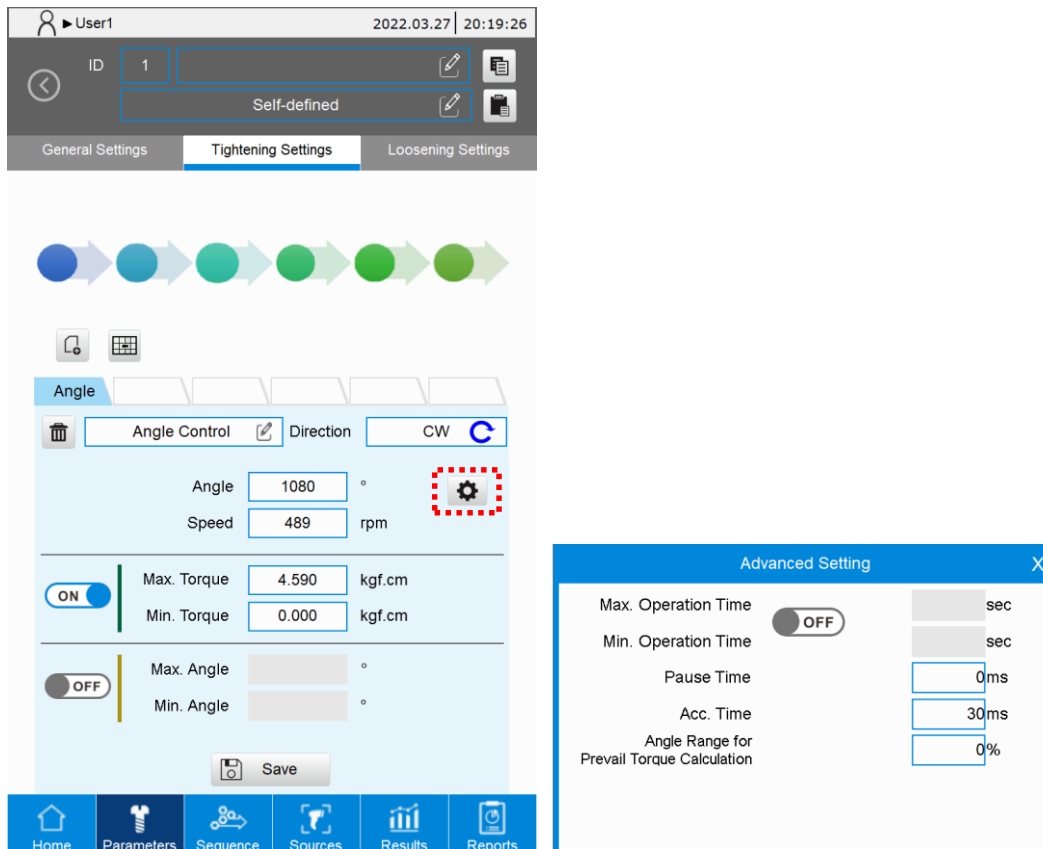

- (1) Angle: after the tool operates to the set angle, the operation for this stage ends.
- (2) Speed: set the operation speed of this stage.
- (3) Max. Torque: set the maximum torque of this stage. You can turn this function on or off.
- (4) Min. Torque: set the minimum torque of this stage. You can turn this function on or off.
- (5) Max. Angle: set the maximum angle of this stage. You can turn this function on or off.
- (6) Min. Angle: set the minimum angle of this stage. You can turn this function on or off.

Advanced Setting:

- (1) Max. Operation Time: set the maximum operation time for this stage. You can turn this function on or off.
- (2) Min. Operation Time: set the minimum operation time for this stage. You can turn this function on or off.
- (3) Pause Time: set the pause time after the set angle is reached. (0: disable Pause Time)
- (4) Acc. Time: adjust the acceleration time for this stage.
- (5) Angle Range for Prevail Torque Calculation: set a percentage of the total rotation angle in this stage for calculating the average torque. For example, if the total rotation angle in this stage is 1000°, and the Angle Range for Prevail Torque Calculation is set as 70%, then the average torque of the last 700° in this stage is automatically calculated during the tightening process.

B. Torque Control: when tightening, the tool stops after operating to the specified torque.

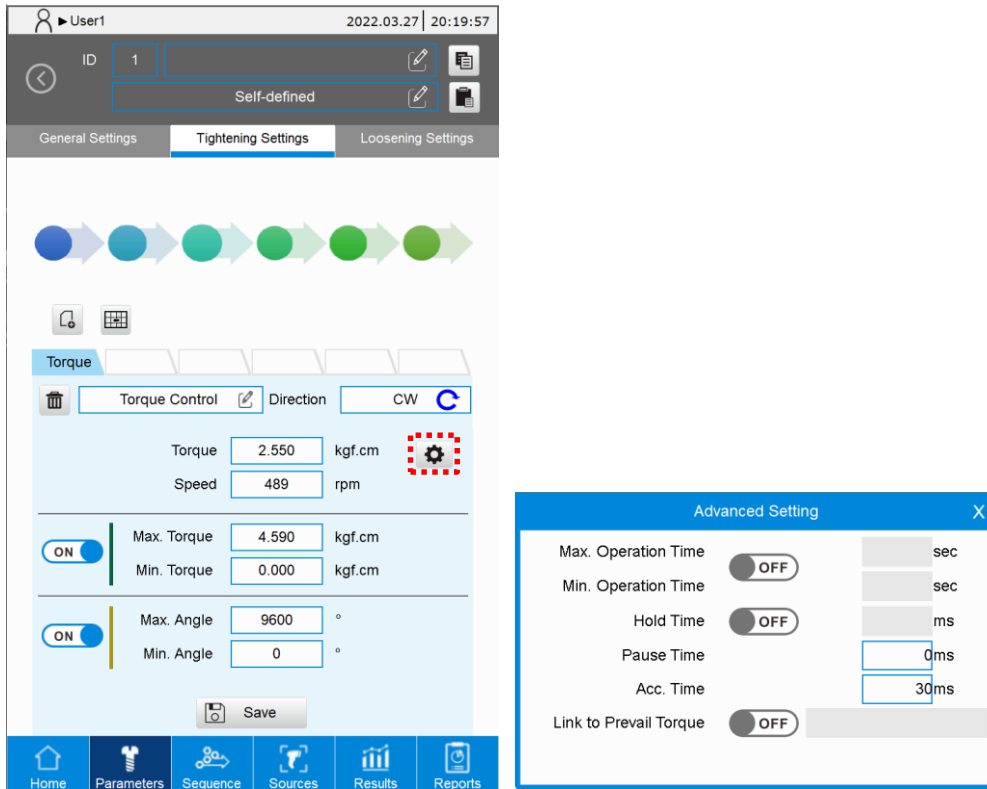

- (1) Torque: after the tool operates to the set torque, the operation for this stage ends.
- (2) Speed: set the operation speed of this stage.
- (3) Max. Torque: set the maximum torque of this stage. You can turn this function on or off.
- (4) Min. Torque: set the minimum torque of this stage. You can turn this function on or off.
- (5) Max. Angle: set the maximum angle of this stage. You can turn this function on or off.
- (6) Min. Angle: set the minimum angle of this stage. You can turn this function on or off.

Advanced Setting:

- (1) Max. Operation Time: set the maximum operation time for this stage. You can turn this function on or off.
- (2) Min. Operation Time: set the minimum operation time for this stage. You can turn this function on or off.
- (3) Hold Time: the duration of keeping the Servo ON state after the tightening torque is reached, which can enhance the tightening effect. You can turn this function on or off.
- (4) Pause Time: set the pause time after the set torque is reached. Cannot be used when Hold Time is enabled.
- (5) Acc. Time: adjust the acceleration time for this stage.
- (6) Link to Prevail Torque: link to the prevail torque saved in different tightening parameters to compensate the final torque in this stage. You can turn this function on or off.

C. Torque Rate Control: when tightening, the tool stops after operating to the specified torque rate.

5

- (1) Torque Rate: after the tool operates to the set torque rate, the operation for this stage ends.
- (2) Speed: set the operation speed of this stage.
- (3) Max. Torque: set the maximum torque of this stage.
- (4) Min. Torque: set the minimum torque of this stage.
- (5) Max. Angle: set the maximum angle of this stage. You can turn this function on or off.
- (6) Min. Angle: set the minimum angle of this stage. You can turn this function on or off.

Advanced Setting:

- (1) Max. Operation Time: set the maximum operation time for this stage. You can turn this function on or off.
- (2) Min. Operation Time: set the minimum operation time for this stage. You can turn this function on or off.
- (3) Pause Time: set the pause time after the set torque is reached.
- (4) Acc. Time: adjust the acceleration time for this stage.
- (5) Angle Interval for Torque Rate Calculation: this function filters out the power surge during operation, but when the setting is too large, the curvature of torque rate is more likely to become distorted.

5.3.3 Loosening settings

The screens of Loosening Settings for all tightening strategies are the same (only the curve graphs are different). In this section, the Loosening Settings screen of Standard strategy is used as an example.

You can set the loosening parameters of two stages in the Loosening Settings screen.

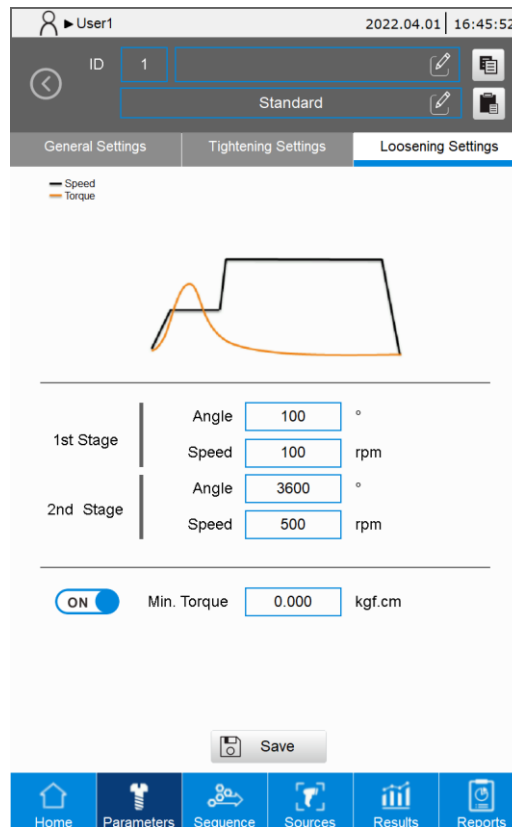

- (1) Angle of 1st Stage: after the tool operates to the set angle, the system switches to the second stage of Loosening. The angle set for this stage must be sufficient for the screwdriver to remove the screw properly.
- (2) Speed of 1st Stage: the torque in the 1st stage is higher than the 2nd Stage, so the speed should not be set too high. The default speed is 100 rpm.
- (3) Angle of 2nd Stage: set a fixed reverse angle, and the loosening operation automatically stops when the set angle is reached.

Note: the system regards that the loosening operation has ended when the set loosening angle is reached or the servo screwdriver is withdrawn during the loosening process.

- (4) Speed of 2nd Stage: this can be set higher than the Speed of 1st Stage, but should not exceed the max. speed for the tool. The default value is 70% of the tool max. speed.
- (5) Min. Torque: set the minimum torque of this stage. You can turn this function on or off.

When to use: when the actual torque is higher than the minimum loosening torque, this setting can be used to identify whether the screw is loosened properly.

5

5.4 Save parameters

In the following operating scenarios, click the **Save** button to save the parameters you have input:

1. After creating and setting the parameters, click **Save**.
2. Modify the created parameters. After the modifications are completed, click **Save**.
3. If the parameter you are editing is currently running, click **Save**, and the Results page automatically updates the operating parameters.

5.5 Copy and paste parameters

You can copy and paste the parameters settings, which increases the efficiency in editing. The following example illustrates the copy and paste process.

1. Go to the editing screen of parameter ID 1, then click the **Copy** icon.

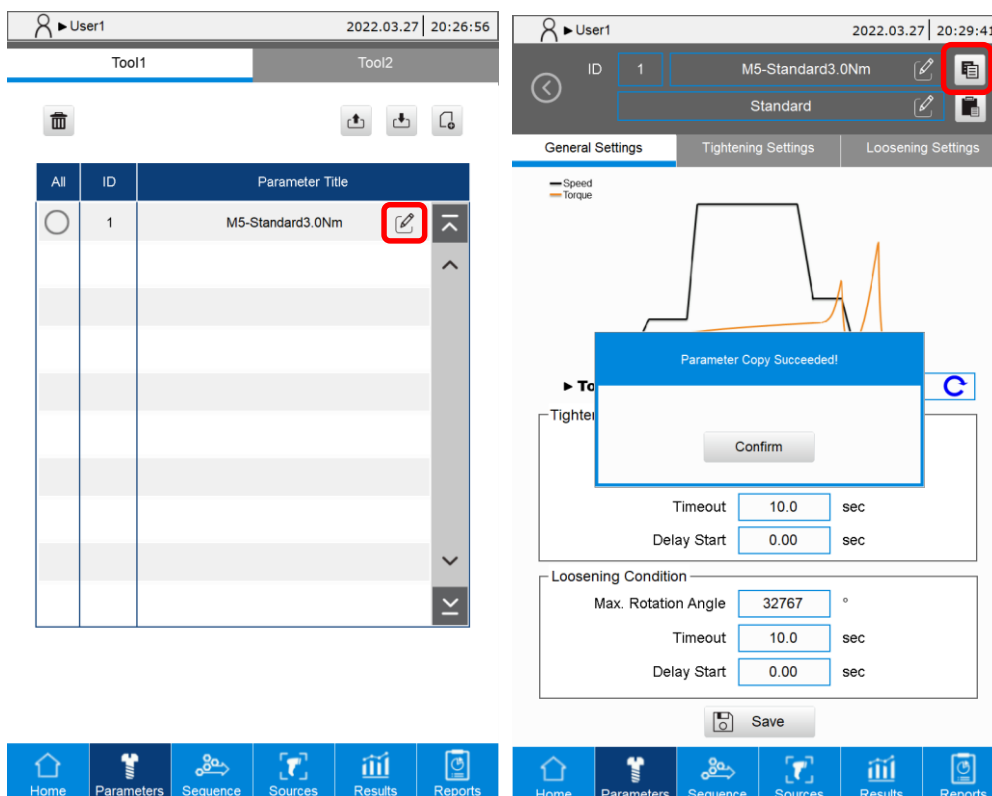

- Click the parameter ID to open the parameter list, then select the parameter you want to paste.

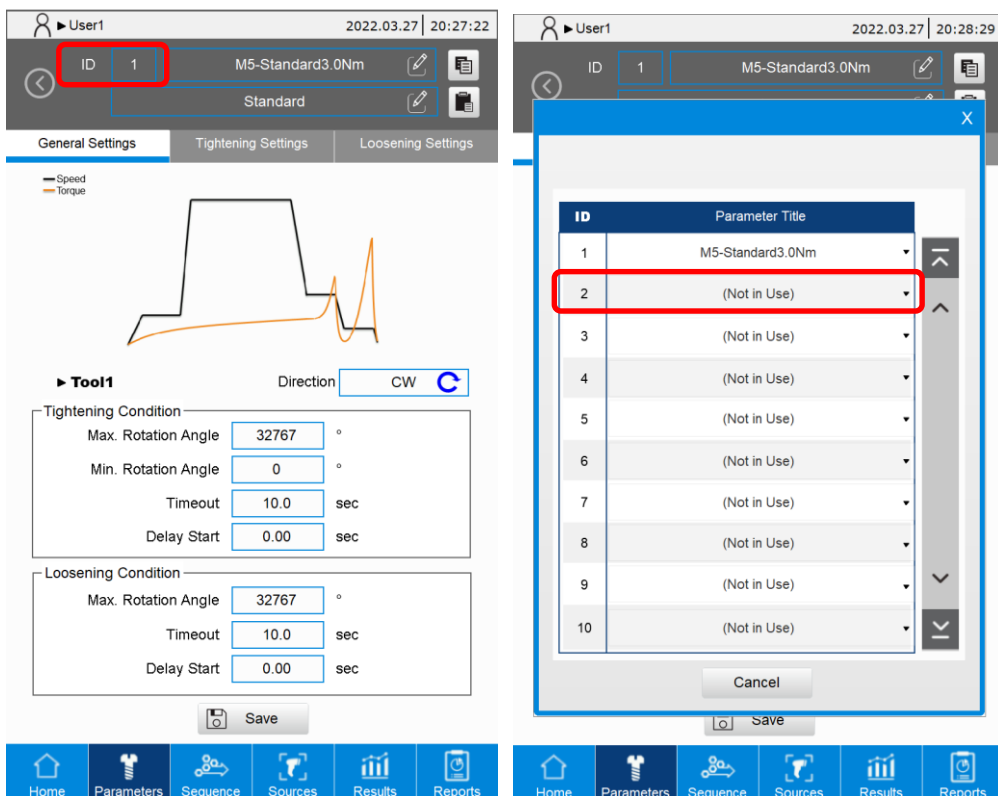

5

- Go to the setting screen of the selected parameter. Click the **Paste** icon, and the message showing pasting successful appears.

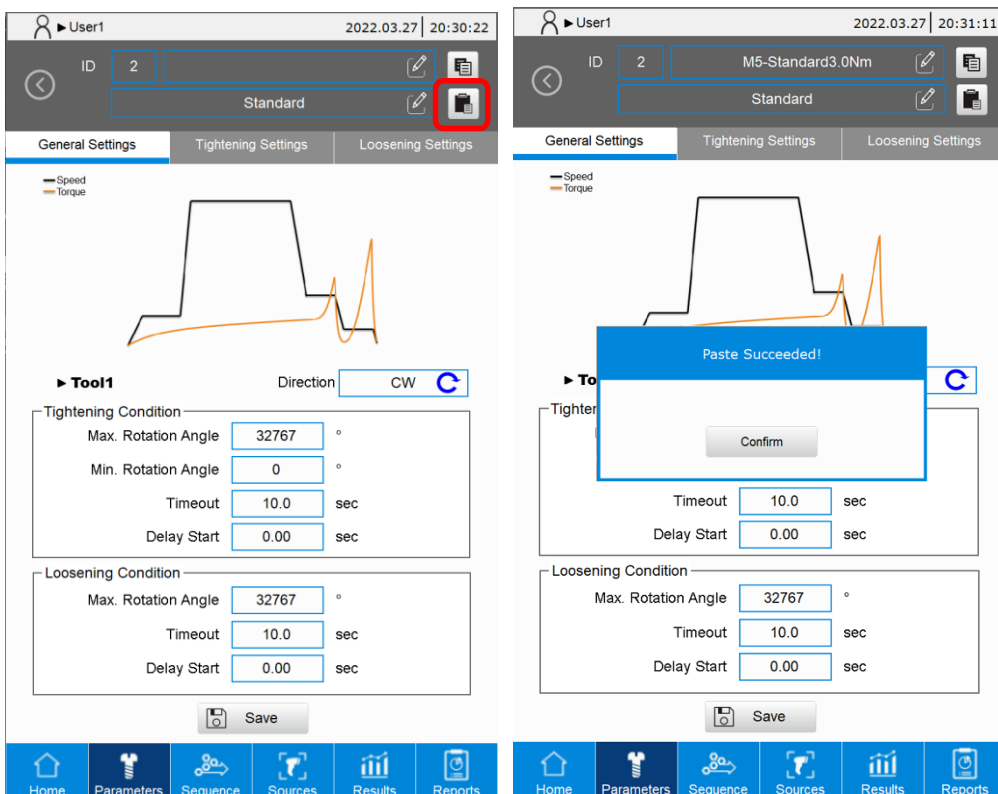

5

5.6 Delete parameters

Select the parameter you want to delete. Click the  icon, then a delete confirmation window pops up. Press **Confirm** to delete the selected parameter.

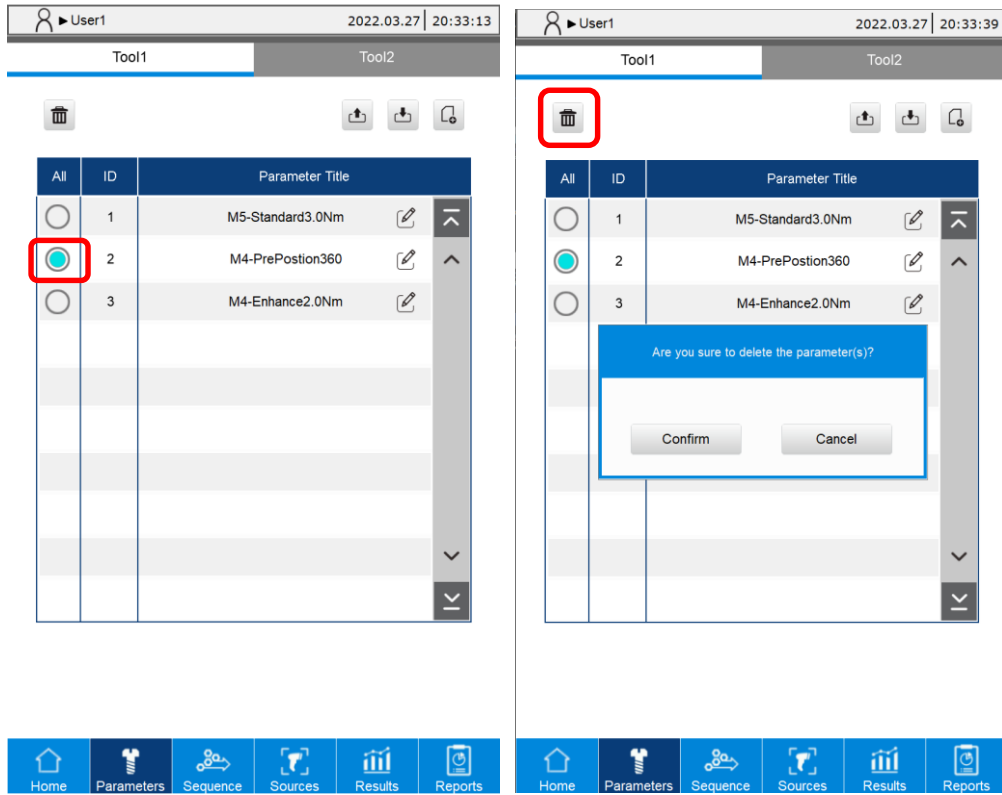

5.7 Import / export parameters

You can use the import (📁) and export (📤) function with a USB drive for data backup and management.

5

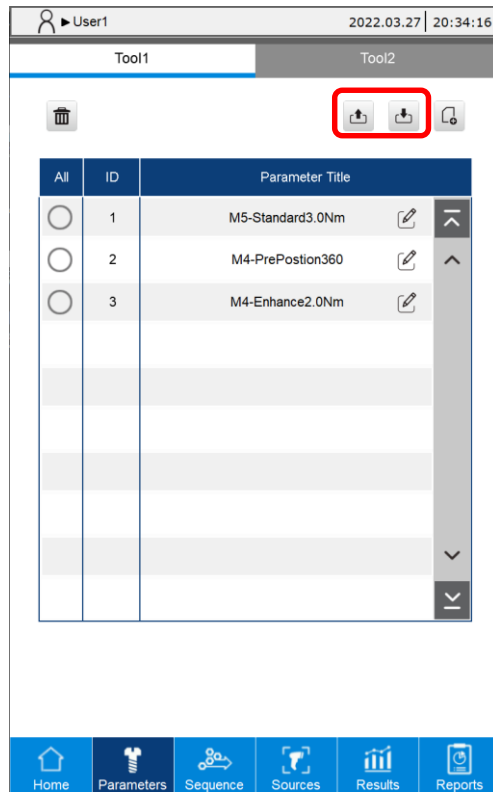

(This page is intentionally left blank.)

5

Sequence (Tightening Sequence)

6

This chapter introduces the use of the Sequence page of the controller for smart servo screwdrivers. You can add, arrange, save, copy / paste, delete, and import / export the screw tightening sequences with this function.

6.1	Tightening sequence overview	6-2
6.2	Add a tightening sequence	6-4
6.3	Save a tightening sequence.....	6-9
6.4	Copy / paste a tightening sequence.....	6-10
6.5	Delete a tightening sequence	6-12
6.6	Export / import a tightening sequence	6-13

6.1 Tightening sequence overview



You can add and arrange the tightening sequences on the Sequence overview page. Each row corresponds to a set of tightening sequence. Up to 500 sets of tightening sequences are configurable. In each set, you can store a maximum of 500 tightening parameters.

On the Sequence overview page, it displays the ID, Mode and Sequence Title for the edited tightening sequences.

Among those, the content of the Mode field changes depending on the combination of Tool 1 and Tool 2 set for the tightening parameters.

- Tool 1: in this tightening sequence, all parameters are the tightening parameters of Tool 1.
- Tool 2: in this tightening sequence, all parameters are the tightening parameters of Tool 2.
- Mix: this tightening sequence uses a mix of tightening parameters for Tool 1 and Tool 2.

User1 2022.03.27 20:35:22

ID	Mode	Sequence Title
1	Tool1	ControllerA
2	Tool2	ControllerB
3	Mix	ControllerC

User1 2022.03.27 20:36:24

ID 1 ControllerA

General Navigator

ID	Tool	Parameter Title	Qty.	Bit ID
1	Tool1	M5-Standard3.0Nm	4	0
2	Tool1	M4-PrePostion360	2	0
3	Tool1	M4-Enhance2.0Nm	2	0

Save

Home Parameters Sequence Sources Results Reports

Home Parameters Sequence Sources Results Reports

6

The example of designating a screw tightening sequence is as follows:

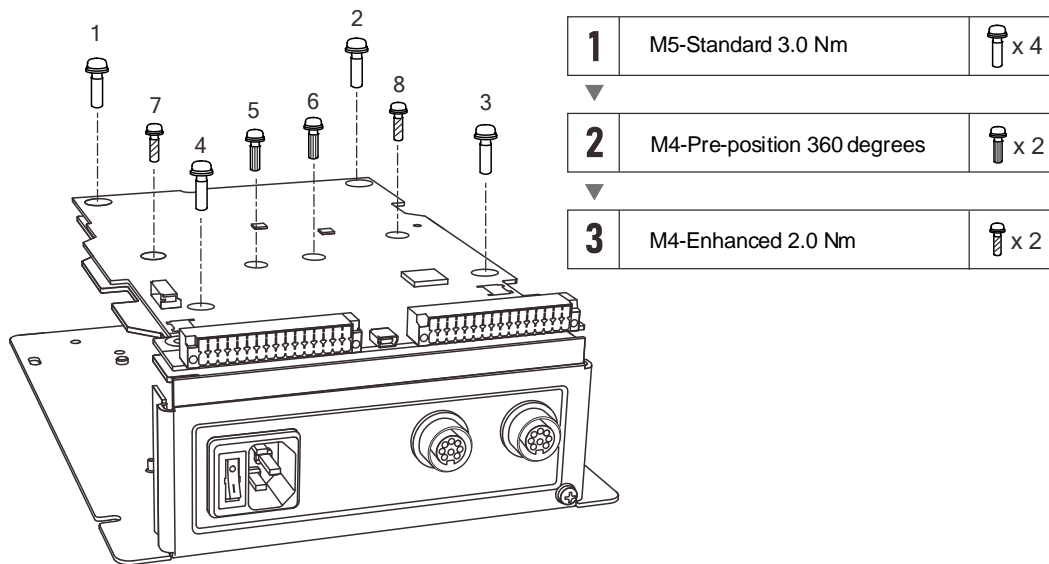

6.2 Add a tightening sequence

Each tightening sequence can store up to 500 sets of tightening parameter arrangements.

Steps for adding a tightening sequence are detailed as follows:

6

1. Click on  , input the title of the tightening sequence, and press **Confirm**.

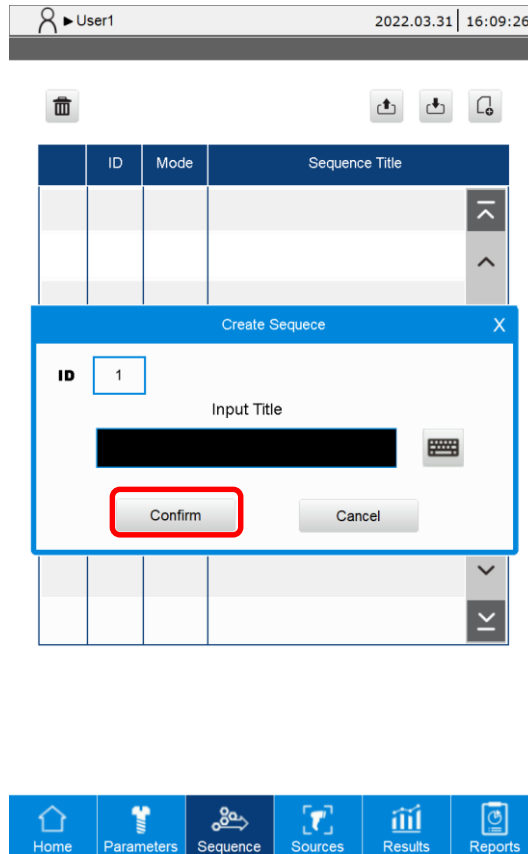

2. After entering the tightening parameter layout screen, click  to open the Parameters overview window. When you click on the designated tightening parameters, the system automatically lists the corresponding parameters on the layout screen.

6

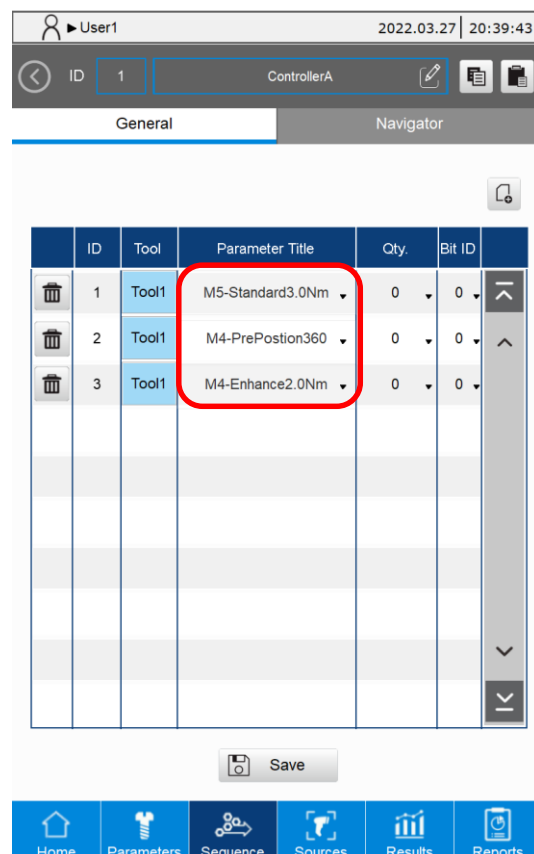
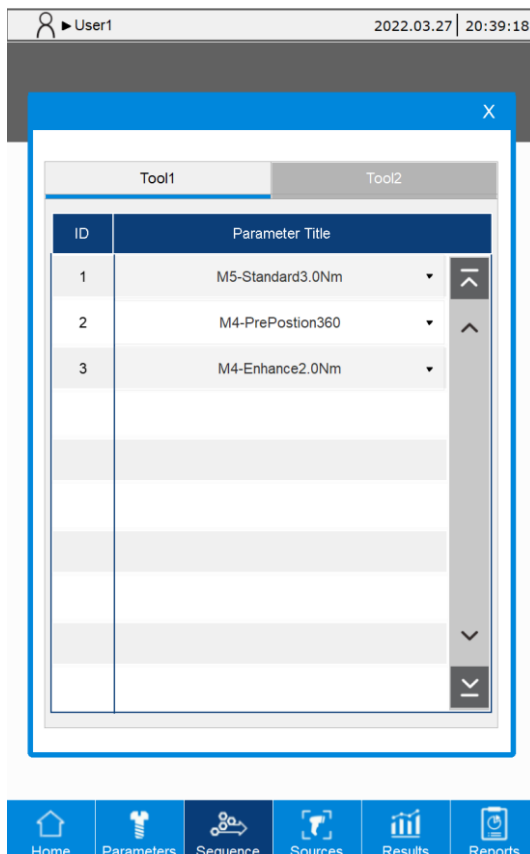
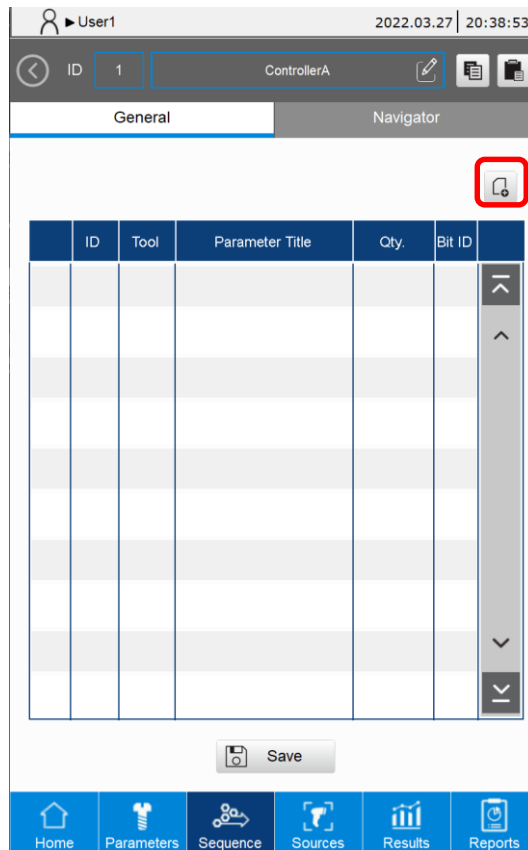

6

- 3. Set the quantity (the number of times the parameter is executed) and Bit ID (the corresponding bit number that is prompted, 0: no prompt) for each tightening parameter.

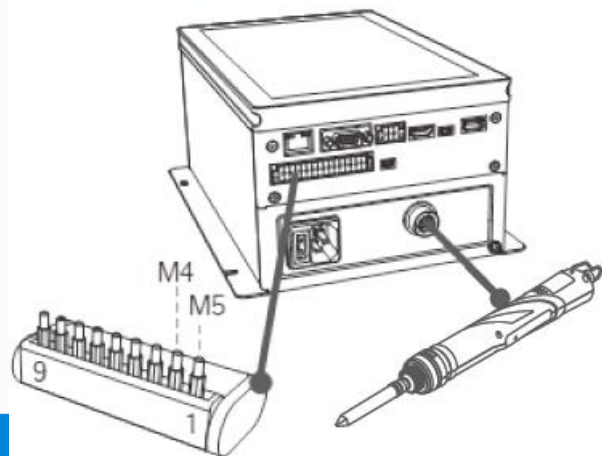
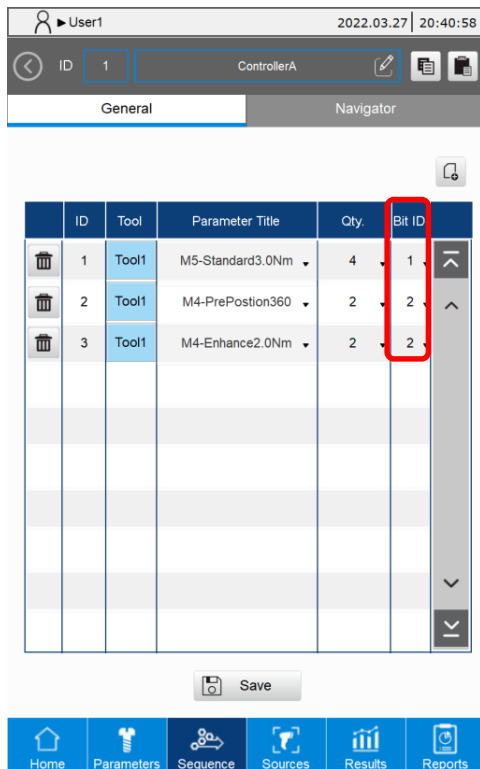
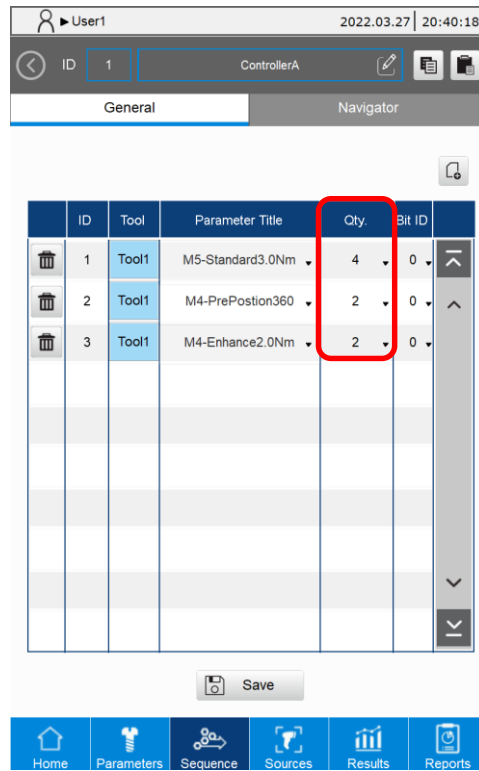

- 4. Go to the Navigator tab. This function is optional, which allows you to import images with a USB drive and drag the screw IDs to the indicating positions on the image.

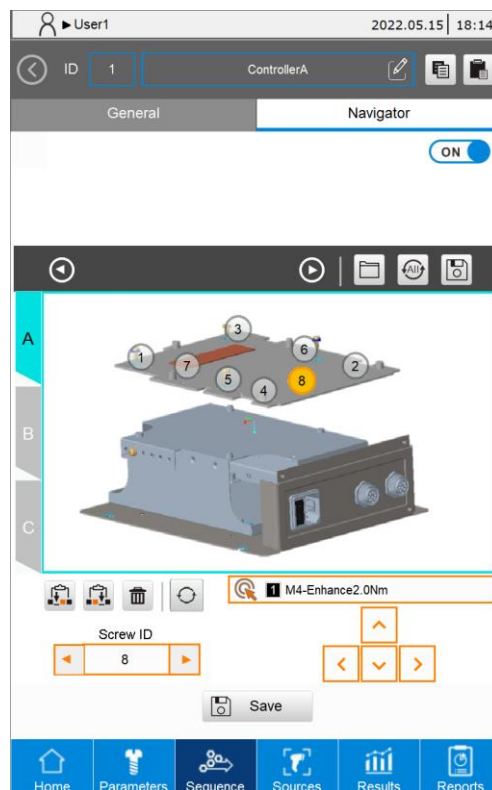
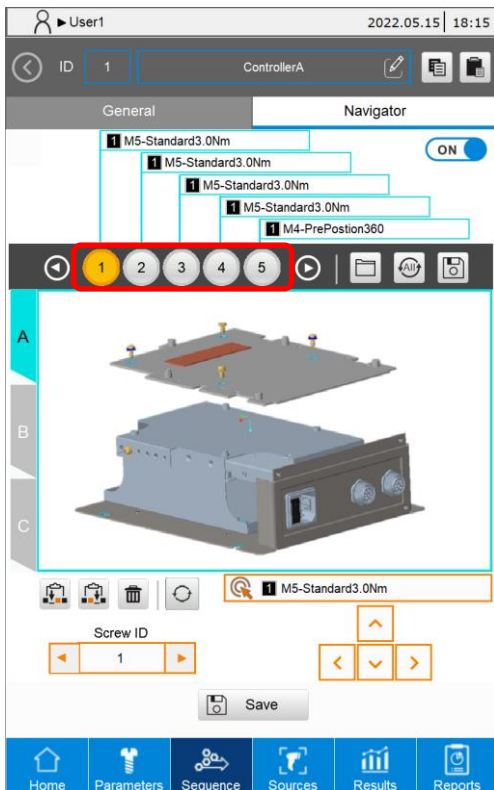
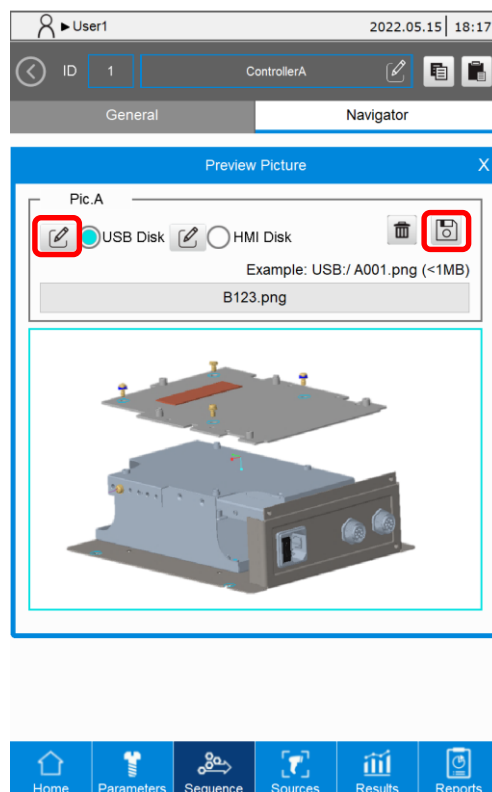
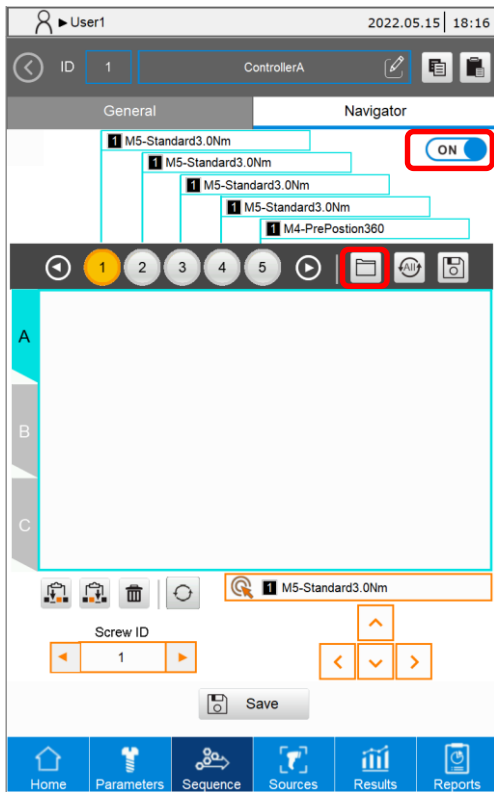

- 5. Click **Save** to save the tightening sequence content.

6

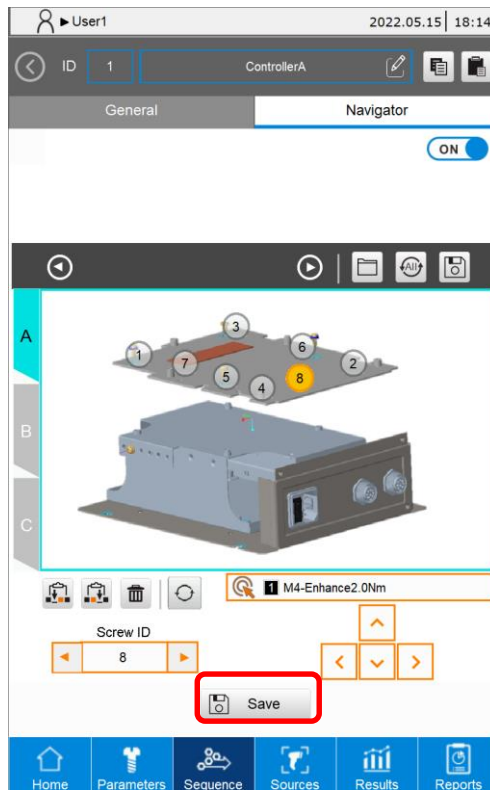

6

6.4 Copy / paste a tightening sequence

The system provides the Copy and Paste function for tightening sequences, which raises the editing efficiency.

1. Enter the editing interface of tightening sequence ID 1.

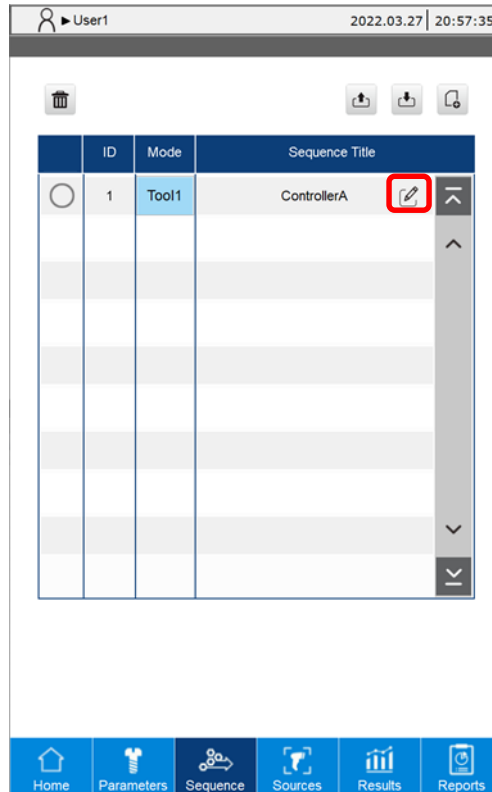

2. Click the Copy icon.

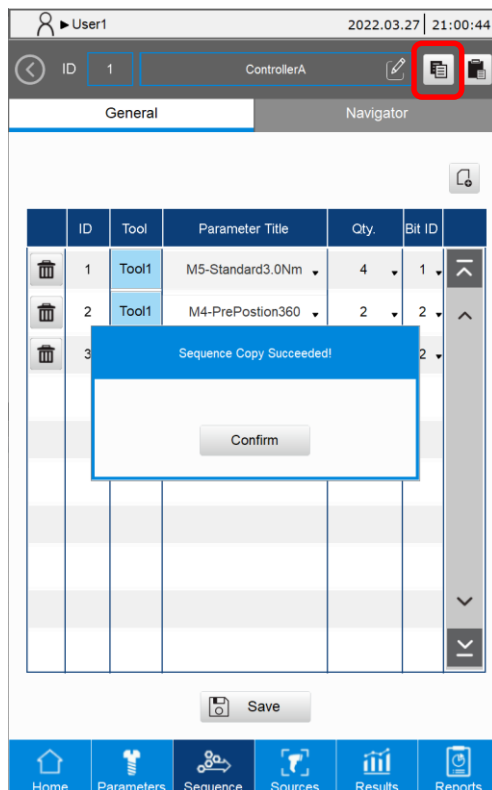

3. Click the tightening sequence ID, and then select the tightening sequence ID to be pasted in the pop-up window.

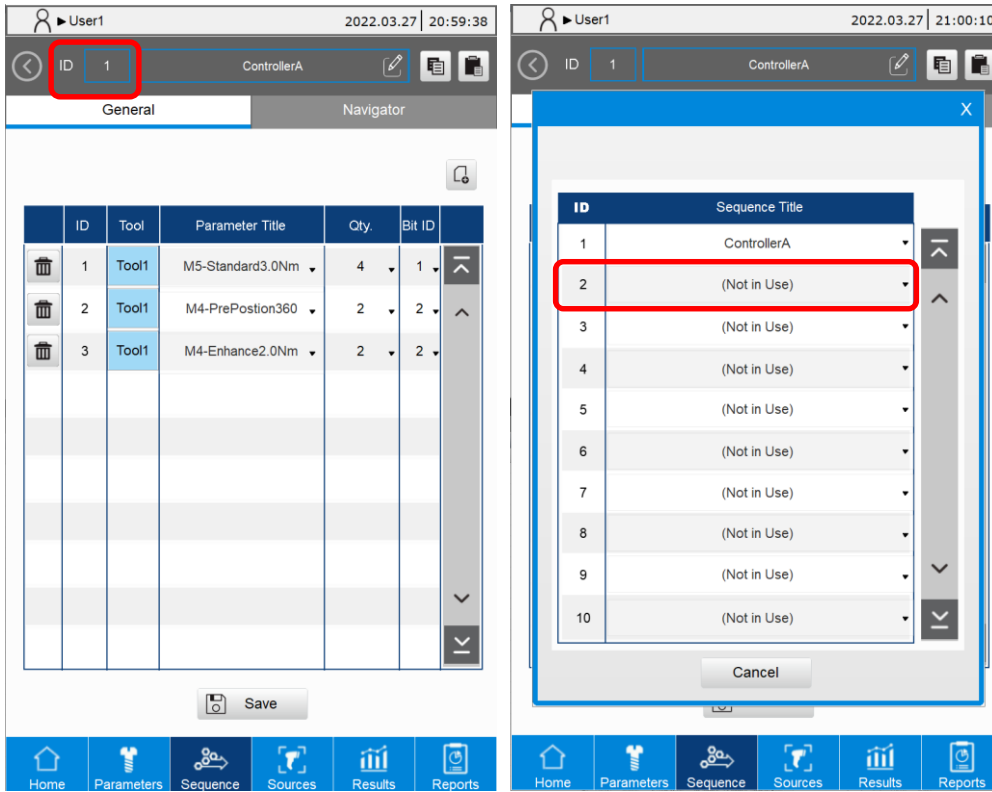

4. Click the Paste icon, and then click the **Save** button.

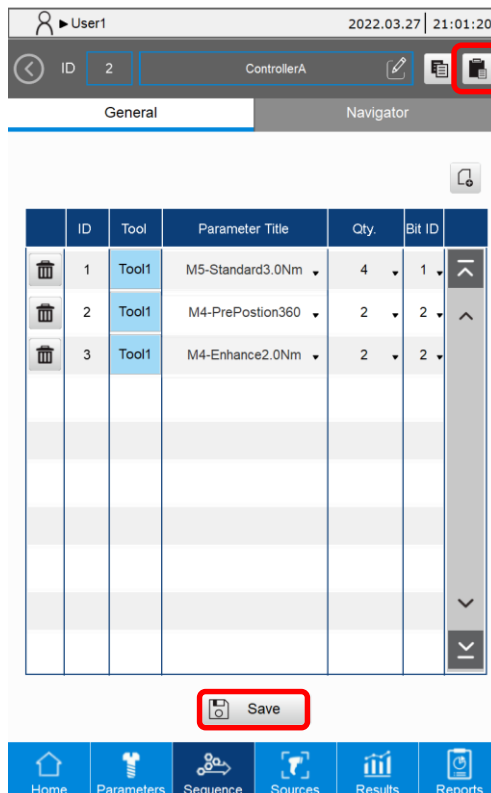



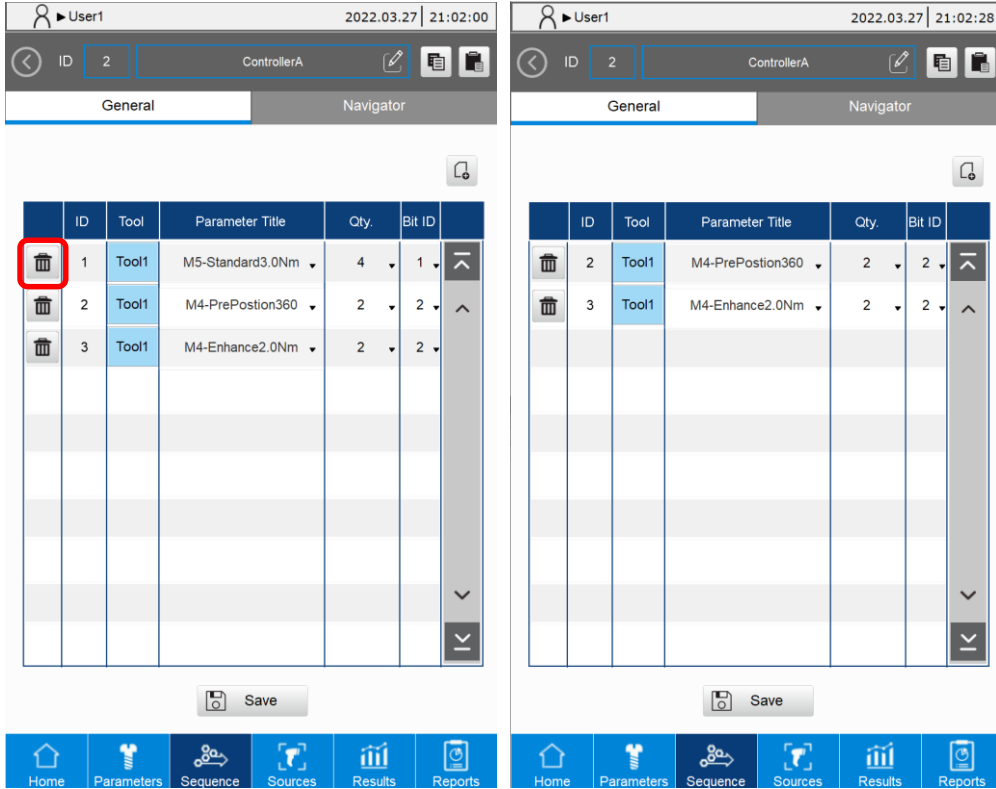

6.5 Delete a tightening sequence

6





1. To delete a parameter of the tightening sequence, click the deletion icon  on the left of the parameter.



The first screenshot shows a table with the following data:

	ID	Tool	Parameter Title	Qty.	Bit ID	
	1	Tool1	M5-Standard3.0Nm	4	1	
	2	Tool1	M4-PrePostion360	2	2	
	3	Tool1	M4-Enhance2.0Nm	2	2	



The second screenshot shows the table after the first parameter has been deleted:

	ID	Tool	Parameter Title	Qty.	Bit ID	
	2	Tool1	M4-PrePostion360	2	2	
	3	Tool1	M4-Enhance2.0Nm	2	2	

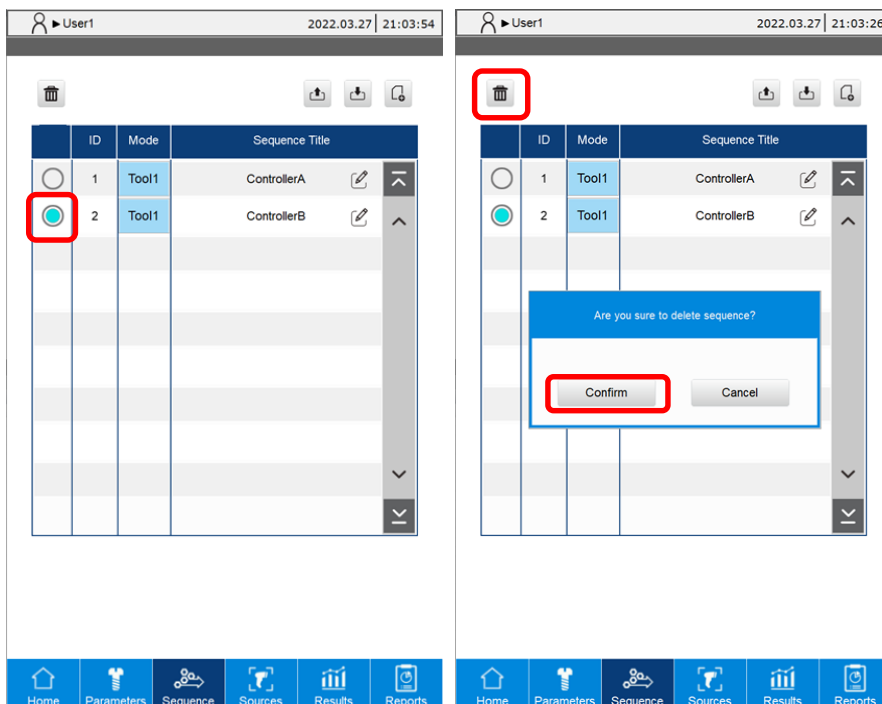
2. To delete the entire tightening sequence, click the radio button on the left, click the deletion icon, and then click **Confirm** in the window.





The first screenshot shows a table with the following data:

	ID	Mode	Sequence Title	
<input type="radio"/>	1	Tool1	ControllerA	
<input checked="" type="radio"/>	2	Tool1	ControllerB	

The second screenshot shows a confirmation dialog box with the text "Are you sure to delete sequence?" and two buttons: "Confirm" and "Cancel". The "Confirm" button is highlighted with a red box.

6.6 Export / import a tightening sequence

You can use a USB flash drive with the export  / import  function for data backup and management.

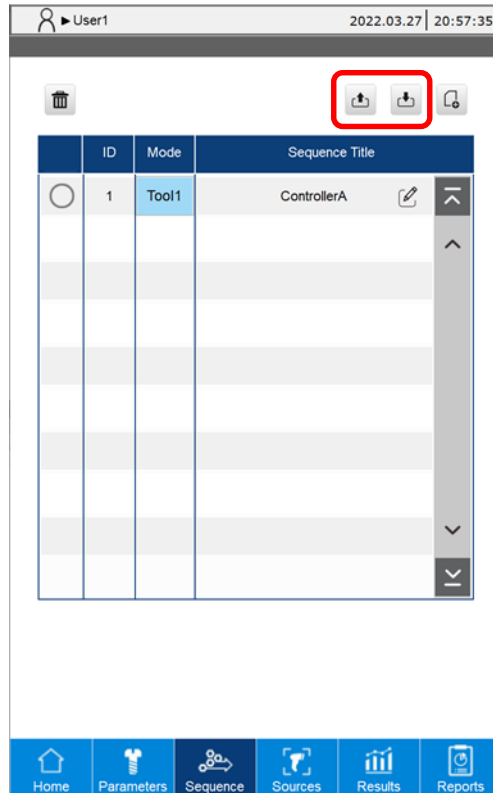

(This page is intentionally left blank.)

6

Sources (Tightening Source)

7

This chapter introduces how to operate the Sources (tightening source) page. You can specify the operating mode and the switching method of the system, which allows you to manually set or use the Screw Bit Selector or the Barcode Scanner to call the tightening parameters or tightening sequence to be executed.

7.1	Operation mode	7-2
7.2	Switching Method	7-4
7.2.1	Manual (Manual setting)	7-5
7.2.2	Screw Bit Selector	7-8
7.2.3	Barcode Scanner	7-12
7.3	Copy a tightening source	7-16
7.4	Delete a tightening source	7-19
7.5	Export / import a tightening source	7-20

7.1 Operation mode

On the Sources page, you can set the operation mode of the system to Single-tool, Dual-tool Alternation, or Dual-tool Synchronization.

- Single-tool: Tool 1 and Tool 2 operate independently.
- Dual-tool Alternation: Tool 1 and Tool 2 operate in succession according to the configured tightening sequence.
- Dual-tool Synchronization: Tool 1 and Tool 2 use the same parameters and run at the same time.

A. In Single-tool operation mode, the tightening parameters or tightening sequence required for Tool 1 and Tool 2 can be set separately.

The two tools operate independently when the system is running.

The image shows two views of the software interface. On the left is a tablet displaying a main menu with options: Parameters, Sequence, Sources (highlighted with a red box), Results, Controller, Tool, Reports, and Help. On the right is a desktop monitor showing the 'Sources' configuration page. The page is titled 'User1' and shows the date '2022.03.27' and time '21:15:48'. The 'Single-tool' mode is selected. The configuration is for 'Tool1' and 'Tool2'. Each tool has a 'Switching Method' set to 'Manual'. Below each tool name is a table with columns: Title, Qty, Bit ID, and Set.

Tool	Title	Qty	Bit ID	Set
Tool1	ControllerA	8		⚙️
Tool2	ControllerB	4		⚙️

- B. In Dual-tool Alternation mode, you can add tightening sequences with mixed parameters, meaning that the parameters in the tightening sequence list include the parameters of both Tool 1 and Tool 2. The two tools operate in succession according to the configured tightening sequence when the system is running.

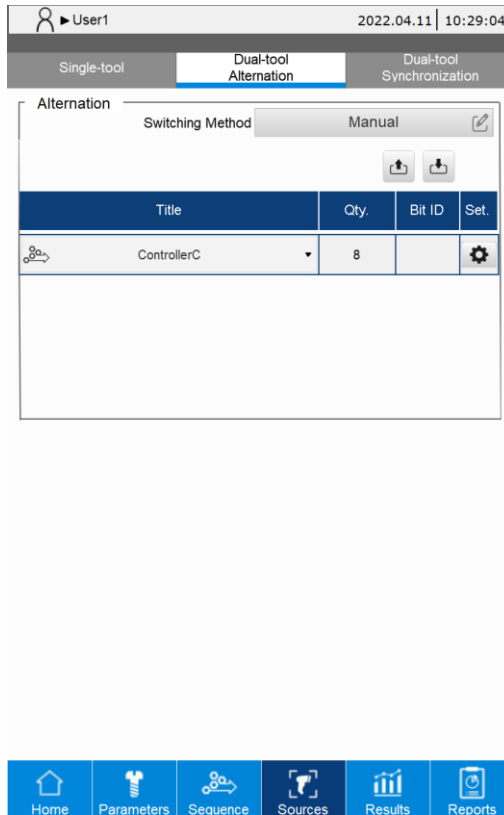

- C. In Dual-tool Synchronization mode, you can select any tightening parameter or tightening sequence. When the system is running, the two tools automatically operates synchronously according to the same parameter settings.

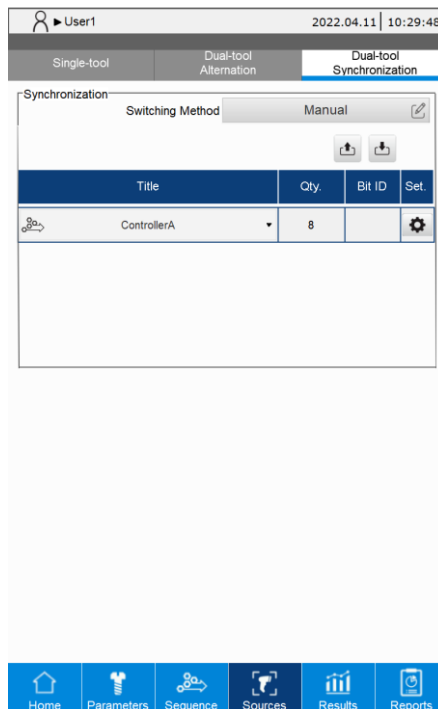

7.2 Switching Method

In each operation mode, you can further choose one of the following switching methods to switch the tightening parameters or tightening sequence.

1. Manual (Manual setting): manually specify the tightening parameters or tightening sequence to be operated.
2. Screw Bit Selector: use the screw bit selector to switch to the corresponding tightening parameters or tightening sequence.
3. Barcode Scanner: scan the barcode using the barcode scanner to switch to the corresponding tightening parameters or tightening sequence.

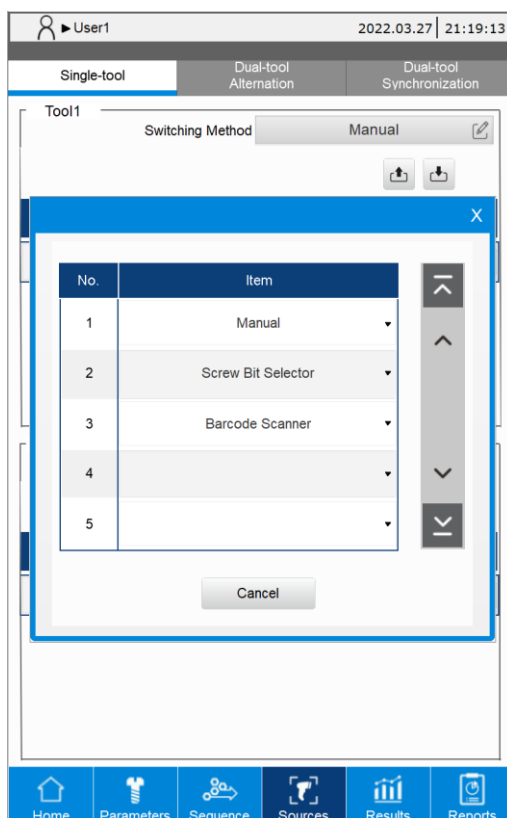

7.2.1 Manual (Manual setting)

When you set the Switching Method to Manual, you can manually specify the tightening parameters or tightening sequence to be operated.

Step 1: on the Sources page, set the operating conditions of the tightening parameters or tightening sequence.

Step 2: select the tightening parameters or tightening sequence to be operated.

Setting instructions for the tightening parameters and tightening sequence are as follows:

A. Parameter (tightening parameters)

- (1) Title: select the tightening parameters.
- (2) Qty.: set the number of screws required for the operation.
- (3) Bit ID: set the bit prompt light (0: no prompt).
- (4) Set.: set the relevant operating limit conditions. Refer to the description for Advanced Setting.

The screenshot displays two windows from the software interface. The left window is a modal dialog for selecting parameters, with a table containing the following data:

Parameter	Sequence
1	M5-Standard3.0Nm
2	M4-PrePostion360
3	M4-Enhance2.0Nm

The right window shows the 'Sources' page for 'Tool1' with the 'Switching Method' set to 'Manual'. Below this, there is a table for parameter selection:

Title	Qty.	Bit ID	Set.
M5-Standard3.0Nm	3	0	[Gear icon]

Callouts (1) through (4) indicate the following UI elements:

- (1) Points to the 'Title' column header.
- (2) Points to the 'Qty.' column header.
- (3) Points to the 'Bit ID' column header.
- (4) Points to the 'Set.' column header.

7

Sequence (tightening sequence)

- (1) Title: select the tightening sequence.
- (2) Qty.: the system automatically fills in the total number of screws required for the tightening sequence.
- (3) Bit ID: the system automatically fills in the bit ID set for the tightening sequence.
- (4) Set.: set the relevant operating limit conditions. Refer to the description for Advanced Setting.

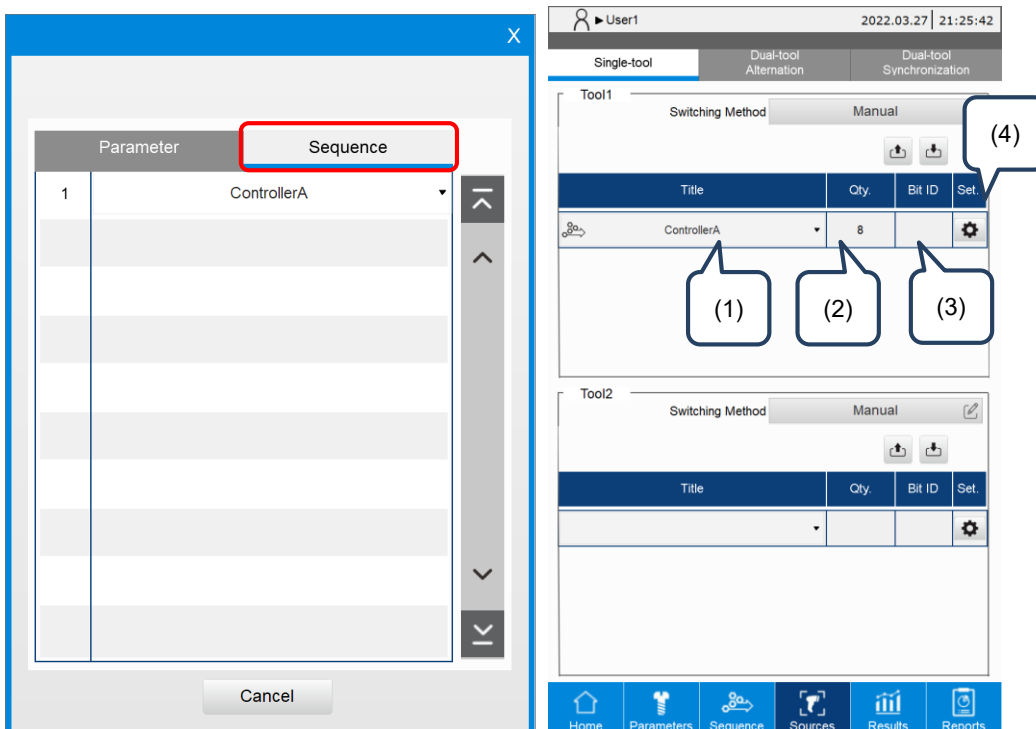

Advanced Setting:

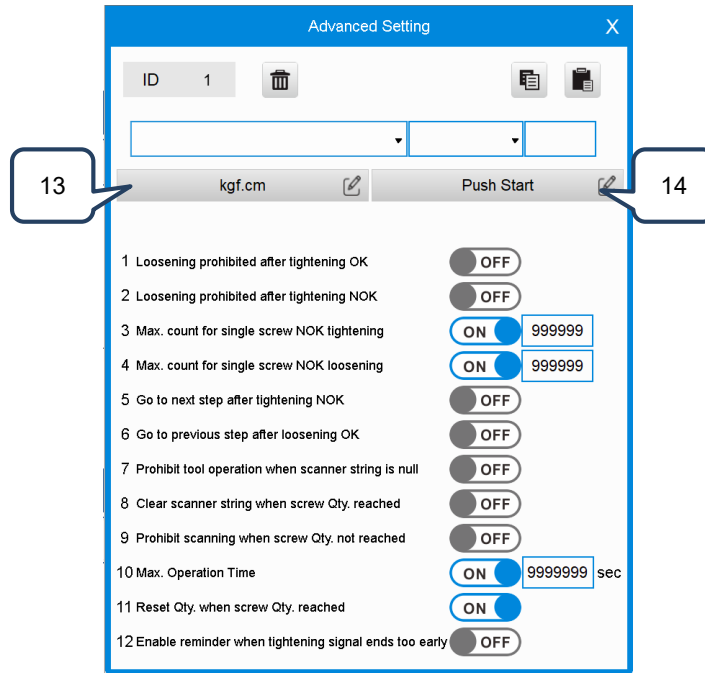

7

Advanced options when using manual settings:

No.	Advanced options	Description
1	Loosening prohibited after tightening OK	Protection condition switch
2	Loosening prohibited after tightening NOK	Protection condition switch
3	Max. count for single screw NOK tightening	Protection condition switch, which refers to the count setting
4	Max. count for single screw NOK loosening	Protection condition switch, which refers to the count setting
5	Go to next step after tightening NOK	Optional function switch
6	Go to previous step after loosening OK	Optional function switch
7	Prohibit tool operation when scanner string is null	Protection condition switch
8	Clear scanner string when screw Qty. reached	Optional function switch
9	Prohibit scanning when screw Qty. not reached	Optional function switch
10	Max. operation time	Protection condition switch, which refers to the total operation duration in units of seconds
11	Reset Qty. when screw Qty. reached	Optional function switch
12	Enable reminder when tightening signal ends too early	Optional function switch
13	Torque unit	Nm, kgf-cm, lbf-ft, lbf-in
14	Start condition	Push Start, DI, Lever Start, Push Start or Lever Start, Push Start and Lever Start

7.2.2 Screw Bit Selector

After you set the Switching Method to Screw Bit Selector, the system automatically identifies and calls the tightening parameters or tightening sequence to be operated when you pick up the bit from the screw bit selector.

Step 1: on the Sources page, set the operating conditions of the tightening parameters or tightening sequence.

Step 2: set the bit for the corresponding tightening parameters or tightening sequence.

The screenshot displays the 'Sources' page in the ST1 Series software. At the top, the user is identified as 'User1' and the date/time is '2022.04.11 | 11:39:30'. Below this, there are three tabs: 'Single-tool', 'Dual-tool Alternation', and 'Dual-tool Synchronization'. The 'Single-tool' tab is active, showing two tool configurations: 'Tool1' and 'Tool2'. Both tools have their 'Switching Method' set to 'Screw Bit Selector'. Tool1's table lists three items:

ID	Title	Qty.	Set.
1	M5-Standard3.0Nm	2	⚙️
2	M4-PrePostion360	4	⚙️
3	ControllerA	8	⚙️

Tool2's table is currently empty. At the bottom of the interface is a navigation bar with icons for Home, Parameters, Sequence, Sources, Results, and Reports.

Step 3: when you pick up the bit from the screw bit selector, the system switches to the corresponding tightening parameters or tightening sequence.

Note: the system refers to the Bit ID Output Table to perform switching. Refer to Section 9.3.

Setting instructions for the tightening parameters and tightening sequence are as follows:

A. Parameter (tightening parameters)

- (1) Title: select the tightening parameters.
- (2) Qty.: set the number of screws required for the operation.
- (3) Set.: set the relevant operating limit conditions. Refer to the description for Advanced Setting.

The image displays two screenshots from a software application. The left screenshot shows a dialog box with a table of parameters. The 'Parameter' column is highlighted with a red box. The right screenshot shows the 'Sources' view of the application, with callouts (1), (2), and (3) pointing to the 'Title', 'Qty.', and 'Set.' columns of the 'Tool1' table.

Parameter	Sequence
1	M5-Standard3.0Nm
2	M4-PrePostion360
3	M4-Enhance2.0Nm

ID	Title	Qty.	Set.
1	M5-Standard3.0Nm	2	

Callouts (1), (2), and (3) are positioned over the 'Title', 'Qty.', and 'Set.' columns of the 'Tool1' table, respectively.

B. Sequence (tightening sequence)

- (1) Title: select the tightening sequence. (Note: you can only select the tightening sequence which has the same Bit ID set for all its tightening parameters.)
- (2) Qty.: the system automatically fills in the total number of screws required for the tightening sequence.
- (3) Set.: set the relevant operating limit conditions. Refer to the description for Advanced Setting.

7

The image displays two screenshots from a software application. The left screenshot shows a dialog box with a table for selecting a sequence. The right screenshot shows the main 'Sources' screen with callouts (1), (2), and (3) pointing to the Title, Qty., and Set. columns of the Tool1 table.

Sequence Selection Dialog:

Parameter	Sequence
1	ControllerA

Sources Screen (Tool1):

ID	Title	Qty.	Set.
1	ControllerA	8	

Sources Screen (Tool2):

ID	Title	Qty.	Set.

Advanced Setting:

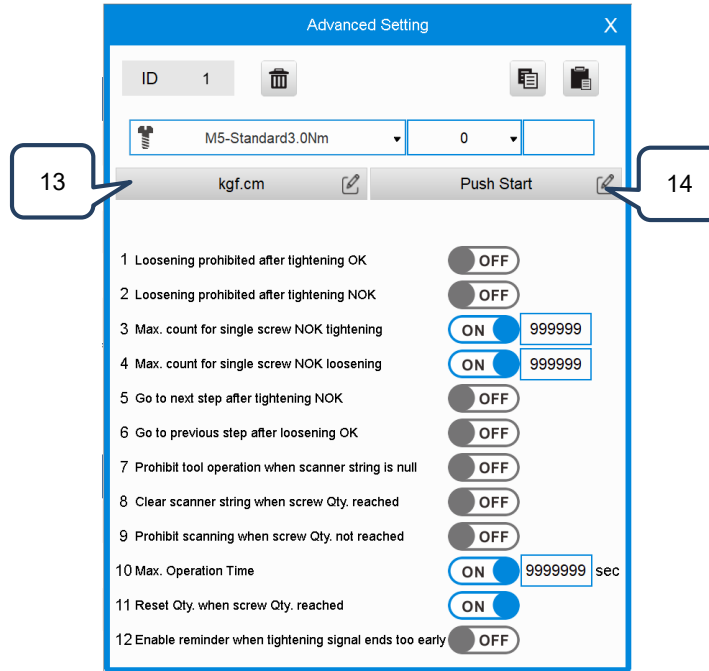

7

Advanced options when using the screw bit selector:

No.	Advanced options	Description
1	Loosening prohibited after tightening OK	Protection condition switch
2	Loosening prohibited after tightening NOK	Protection condition switch
3	Max. count for single screw NOK tightening	Protection condition switch, which refers to the count setting
4	Max. count for single screw NOK loosening	Protection condition switch, which refers to the count setting
5	Go to next step after tightening NOK	Optional function switch
6	Go to previous step after loosening OK	Optional function switch
7	Prohibit tool operation when scanner string is null	Protection condition switch
8	Clear scanner string when screw Qty. reached	Optional function switch
9	Prohibit scanning when screw Qty. not reached	Optional function switch
10	Max. operation time	Protection condition switch, which refers to the total operation duration in units of seconds
11	Reset Qty. when screw Qty. reached	Optional function switch
12	Enable reminder when tightening signal ends too early	Optional function switch
13	Torque unit	Nm, kgf-cm, lbf-ft, lbf-in
14	Start condition	Push Start, DI, Lever Start, Push Start or Lever Start, Push Start and Lever Start

7.2.3 Barcode Scanner

When you set the Switching Method to the Barcode Scanner, the system automatically identifies and calls the tightening parameters or tightening sequence to be operated.

- 7
- Step 1: on the Sources page, set the operating conditions of the tightening parameters or tightening sequence.
- Step 2: select the Barcode and set its corresponding tightening parameters or tightening sequence.

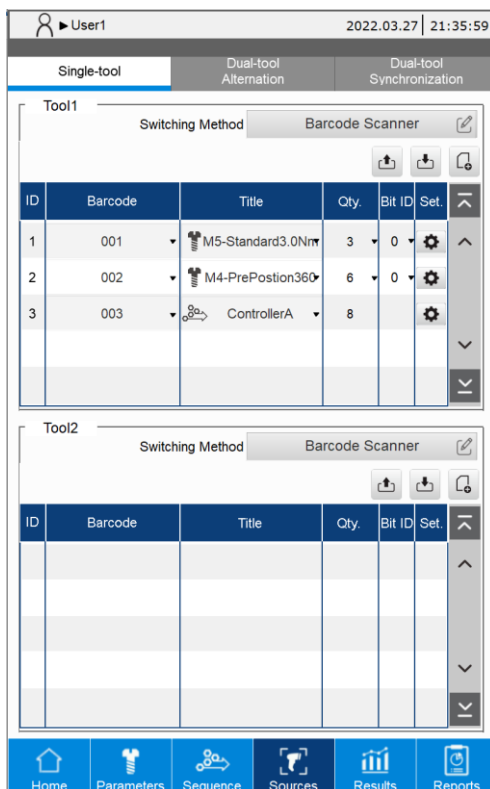

- Step 3: use the scanner to scan the barcode for comparing. Once the comparing is complete, the system switches to the corresponding parameters or sequence.

Setting instructions for the tightening parameters and tightening sequence are as follows:

A. Parameter (tightening parameters)

- (1) Barcode: set the string content to be compared by the barcode scanner.
- (2) Title: select the tightening parameters.
- (3) Qty.: set the number of screws required for the operation.
- (4) Bit ID: set the bit prompt light (0: no prompt).
- (5) Set.: set the relevant operating limit conditions. Refer to the description for Advanced Setting.

The image displays two screenshots from a software application. The left screenshot shows a dialog box with a table of parameters and sequences. The right screenshot shows the main application interface with callouts (1) through (5) pointing to specific fields in the Tool1 table.

Left Screenshot: Parameter Selection Dialog

Parameter	Sequence
1	M5-Standard3.0Nm
2	M4-PrePostion360
3	M4-Enhance2.0Nm

Right Screenshot: Main Application Interface

Tool1

Switching Method: Barcode Scanner

ID	Barcode	Title	Qty.	Bit ID	Set.
1	001	M5-Standard3.0Nm	3	0	

Tool2

Switching Method: Barcode Scanner

ID	Barcode	Title	Qty.	Bit ID	Set.

Callouts (1) through (5) point to the Barcode, Title, Qty., Bit ID, and Set. columns of the Tool1 table, respectively.

B. Sequence (tightening sequence)

- (1) Barcode: set the string content to be compared by the barcode scanner.
- (2) Title: select the tightening sequence.
- (3) Qty.: the system automatically fills in the total number of screws required for the tightening sequence.
- (4) Bit ID: the system automatically fills in the bit ID set for the tightening sequence.
- (5) Set.: set the relevant operating limit conditions. Refer to the description for Advanced Setting.

The screenshot displays the 'Sequence' configuration window. On the left, a 'Parameter' table shows 'Sequence' selected. The main window shows 'Tool1' configuration with a 'Barcode Scanner' switching method. The following table represents the data shown in the Tool1 configuration:

ID	Barcode	Title	Qty.	Bit ID	Set.
1	001	ControllerA	8		

Callouts (1) through (5) indicate the Barcode, Title, Qty., Bit ID, and Set. columns respectively. A 'Cancel' button is visible at the bottom of the parameter window.

Advanced Setting:

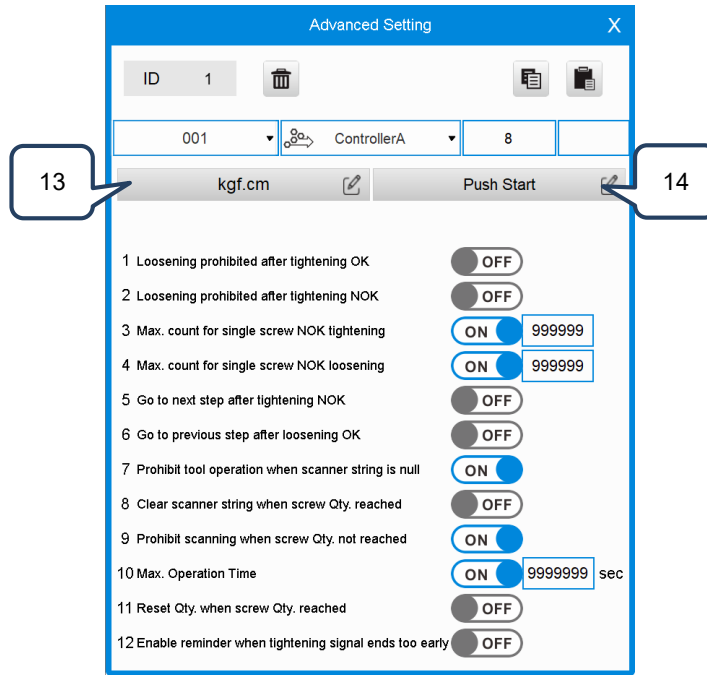

7

Advanced options when using the barcode scanner:

No.	Advanced options	Description
1	Loosening prohibited after tightening OK	Protection condition switch
2	Loosening prohibited after tightening NOK	Protection condition switch
3	Max. count for single screw NOK tightening	Protection condition switch, which refers to the count setting
4	Max. count for single screw NOK loosening	Protection condition switch, which refers to the count setting
5	Go to next step after tightening NOK	Optional function switch
6	Go to previous step after loosening OK	Optional function switch
7	Prohibit tool operation when scanner string is null	Protection condition switch
8	Clear scanner string when screw Qty. reached	Optional function switch
9	Prohibit scanning when screw Qty. not reached	Optional function switch
10	Max. operation time	Protection condition switch, which refers to the total operation duration in units of seconds
11	Reset Qty. when screw Qty. reached	Optional function switch
12	Enable reminder when tightening signal ends too early	Optional function switch
13	Torque unit	Nm, kgf-cm, lbf-ft, lbf-in
14	Start condition	Push Start, DI, Lever Start, Push Start or Lever Start, Push Start and Lever Start

7.3 Copy a tightening source

The system provides the Copy and Paste function, which raises the editing efficiency. The following examples illustrate the operation process.

7

Step 1: click  to create a tightening source ID.

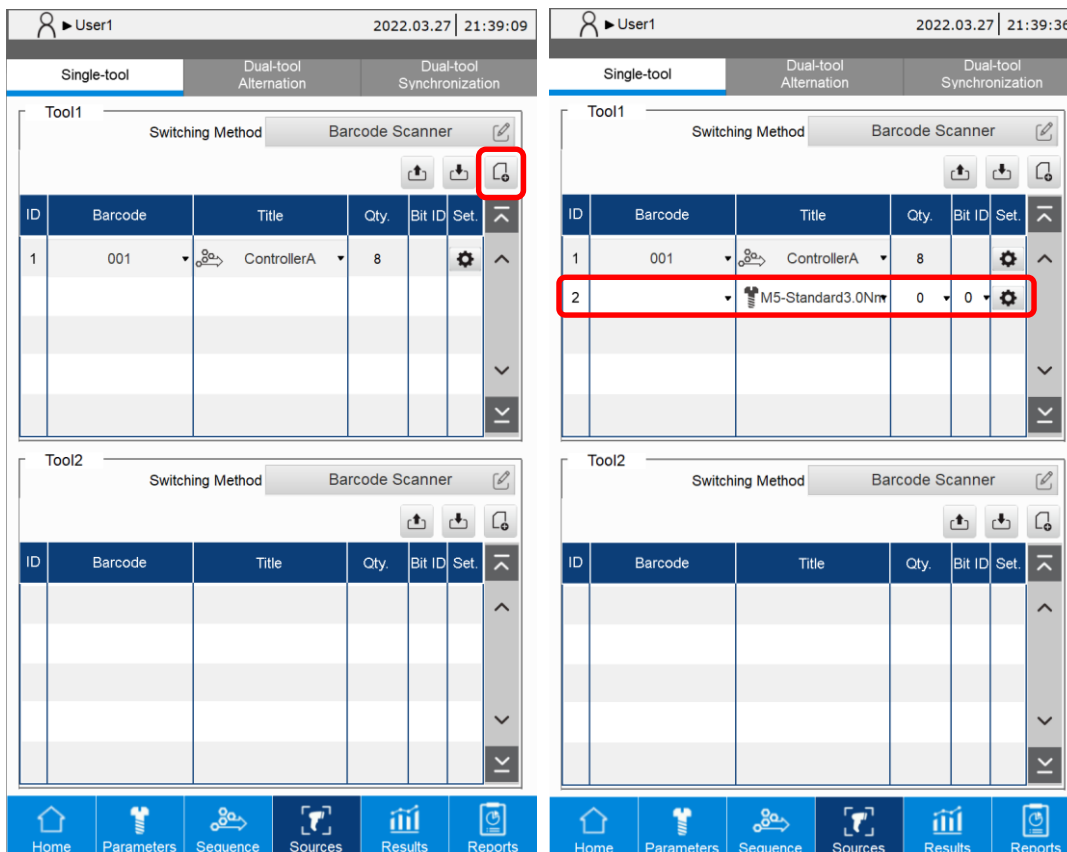

The screenshots show the 'Sources' tab in the software interface. The top navigation bar includes 'Single-tool', 'Dual-tool Alternation', and 'Dual-tool Synchronization'. The main area is divided into 'Tool1' and 'Tool2'. Each tool has a 'Switching Method' dropdown set to 'Barcode Scanner' and a 'Barcode Scanner' icon. Below each tool is a table with columns: ID, Barcode, Title, Qty, Bit ID, and Set. The bottom navigation bar includes icons for Home, Parameters, Sequence, Sources, Results, and Reports.

ID	Barcode	Title	Qty.	Bit ID	Set.
1	001	ControllerA	8		
2	M5-Standard3.0Nr		0	0	

Step 2: enter the Advanced Setting in the Sources page, then click the Copy icon .

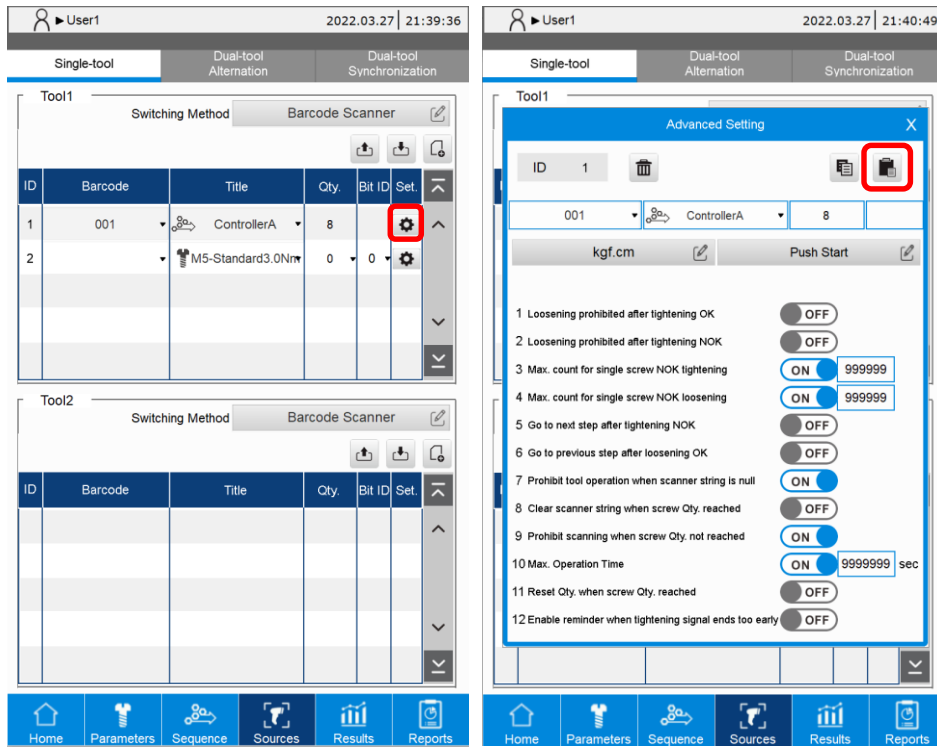

7

Step 3: return to the Sources overview page, go to the Advanced Setting window of the Source page for pasting the content, and then click the Paste icon .

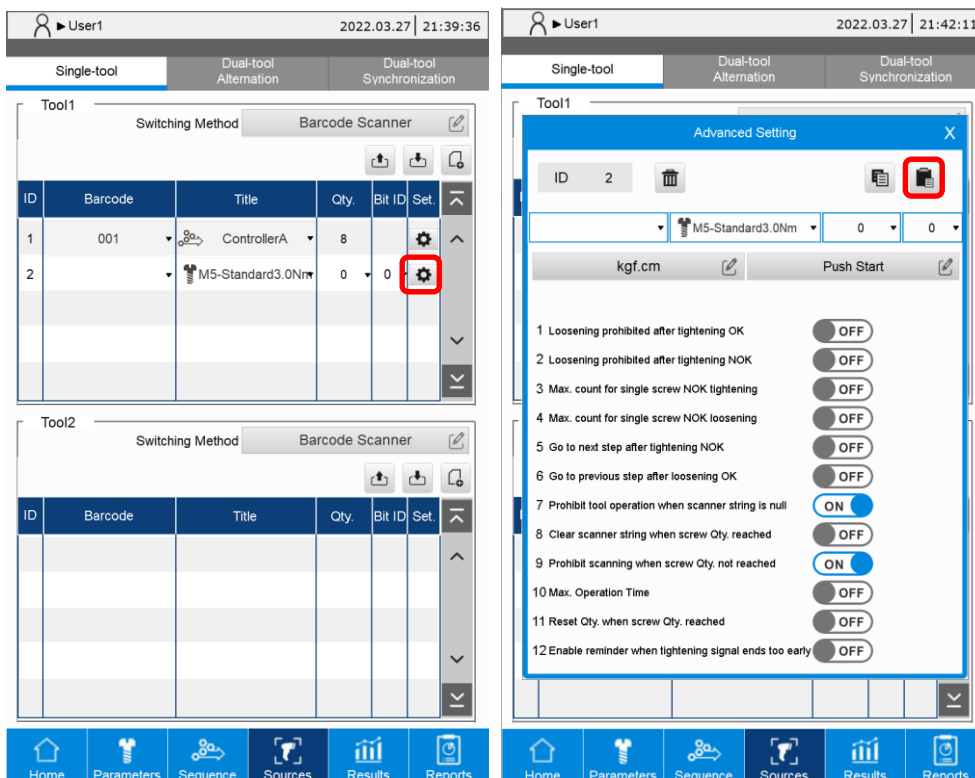

Step 4: go back to the Sources overview page, where you can see the tightening source ID 1 has been successfully copied to tightening source ID 2.

7

The screenshot displays a software interface for configuring tools. At the top, it shows the user 'User1' and the date/time '2022.03.27 | 21:42:49'. Below this is a navigation bar with three tabs: 'Single-tool' (selected), 'Dual-tool Alternation', and 'Dual-tool Synchronization'. The main area is divided into two sections, 'Tool1' and 'Tool2'. Each section has a 'Switching Method' dropdown set to 'Barcode Scanner' and a 'Barcode Scanner' button. Below each section is a table with columns: ID, Barcode, Title, Qty, Bit ID, and Set. Tool1's table contains two rows: ID 1, Barcode 001, Title ControllerA, Qty 8, Bit ID, and Set. Tool2's table is empty. At the bottom, there is a navigation bar with icons for Home, Parameters, Sequence, Sources, Results, and Reports.

ID	Barcode	Title	Qty.	Bit ID	Set.
1	001	ControllerA	8		
2	001	ControllerA	8		

7.4 Delete a tightening source



Enter the Advanced Setting window of the tightening source and click the deletion icon , and you can delete the content of the tightening source.

- When you set the Switching Method to Manual, clicking the deletion icon will clear all the content settings of the tightening source.
- When you set the Switching Method to Screw Bit Selector or Barcode Scanner, clicking the deletion icon will delete the tightening source from the list.

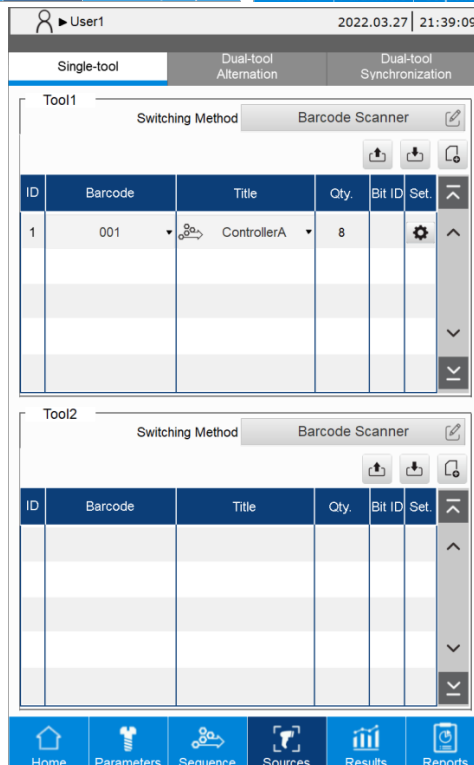
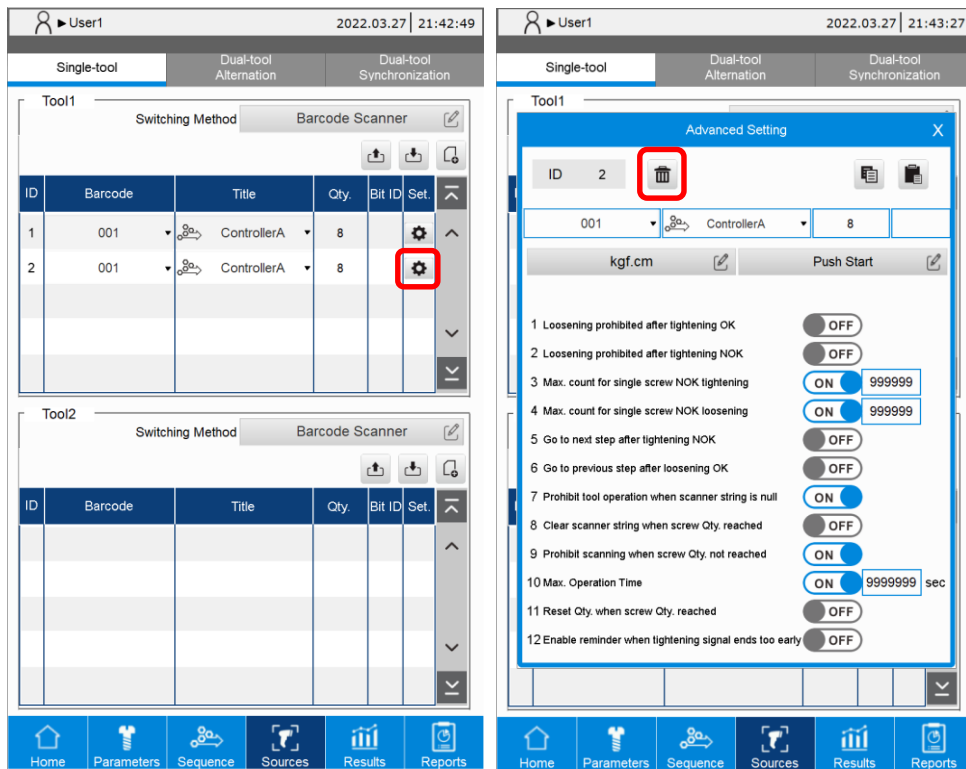
7



7.5 Export / import a tightening source

You can use the import () / export () function with a USB drive for data backup and management.

7

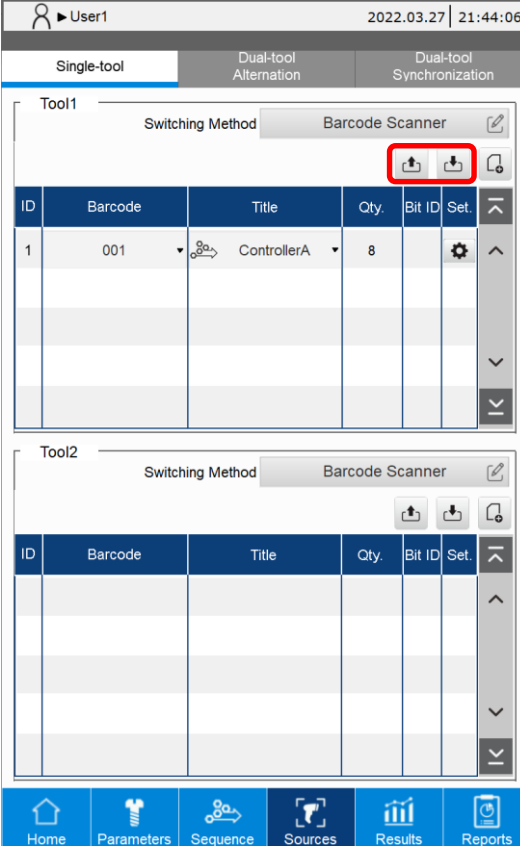

The screenshot displays the 'Sources' management interface. At the top, the user is identified as 'User1' and the date/time is '2022.03.27 | 21:44:06'. The interface is divided into three tabs: 'Single-tool', 'Dual-tool Alternation', and 'Dual-tool Synchronization'. Below these, there are two tool sections, 'Tool1' and 'Tool2'. Each tool section has a 'Switching Method' dropdown set to 'Barcode Scanner' and icons for 'Import' and 'Export'. In the 'Tool1' section, the 'Import' and 'Export' icons are highlighted with a red box. Below the tool sections are two tables with columns: ID, Barcode, Title, Qty, Bit ID, and Set. The 'Tool1' table contains one entry with ID 1, Barcode 001, Title ControllerA, and Qty 8. The 'Tool2' table is currently empty. At the bottom, there is a navigation bar with icons for Home, Parameters, Sequence, Sources (highlighted), Results, and Reports.

ID	Barcode	Title	Qty.	Bit ID	Set.
1	001	ControllerA	8		

Results

8

This chapter introduces the information on the Result page of the controller. This page provides the currently running tightening information and the tightening process curve graph.

8.1	Result (Operation results).....	8-2
8.2	Curve (Operating curve).....	8-8

8.1 Result (Operation results)

8

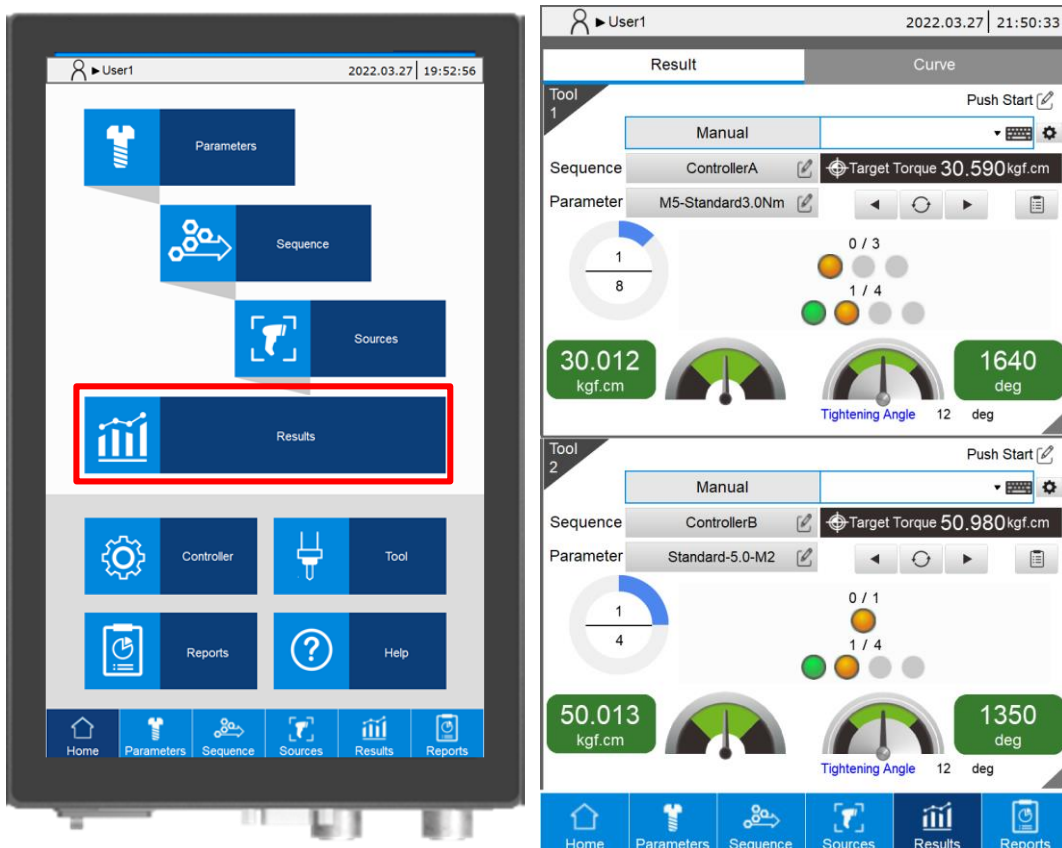

Description of Result page:

The Result page provides information about the currently running tightening tasks. After each tightening is completed, the screen shows the information such as the final tightening status, final torque value, and final angle, so that the operator can easily check the tightening status.

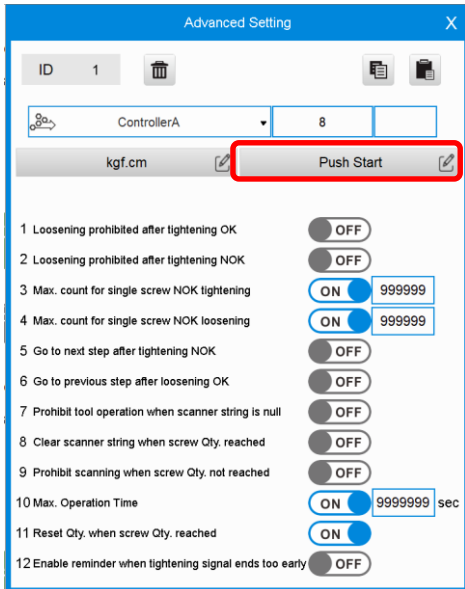
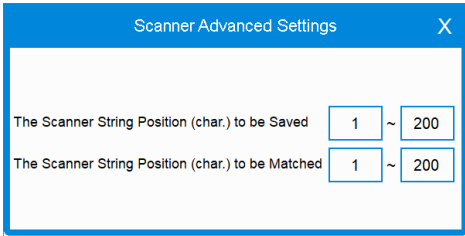

8

Code in the picture	Item	Description
1	Tool start condition	<p>Displays the tool start condition of the servo screwdriver. To edit the tool start condition, click ① shown in the above figure to link to the Advanced Setting window of the Sources (tightening source) page and click the edit button (shown in the red box).</p> 
2	Switching Method	Displays the switching method in operation.
3	Scanner input	The input field of the scanner string.
4	Scanner Advanced Settings	 <p>The Scanner String Position (char.) to be Saved: save the scanner string of the specified position (in characters) and record the string in the Reports. The Scanner String Position (char.) to be Matched: when the Switching Method is Barcode Scanner, the system compares the scanner string of the specified position (in characters) with the corresponding string of tightening sources. If the comparison result is matched, the system calls the corresponding parameters or sequence.</p>

8

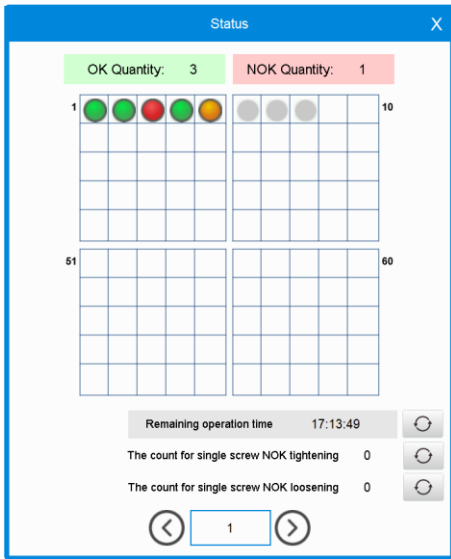
Code in the picture	Item	Description
5	Sequence	The tightening sequence in operation. You can click on the sequence title to directly link to the editing window of the Sequence page.
6	Parameter	The tightening parameter in operation. You can click on the parameter title to directly link to the editing window of the Parameters page.
7	Target torque or angle	Displays the final target torque or target angle of the operation.
8	Previous step	Execute tightening using the parameters of the previous screw.
9	Progress reset	Reset the total quantity of screws, quantity of parameters, and quantity of screws in the parameter that have been tightened.
10	Next step	Execute tightening using the parameters of the next screw.
11	Status	 <p>The lights indicate the tightening status of all screws: Green: tightening OK. Red: tightening NOK. Yellow: no tightening status or operation in progress.</p>
12	Total quantity of screws	The quantity of completed screws / total quantity of screws (999999 represents an unlimited number), displayed with the progress bar.
13	Quantity of parameters	The quantity of completed tightening parameters / total quantity of tightening parameters, displayed with the light indicators.
14	Quantity of screws in the parameter	The quantity of completed screws in the tightening parameter / total quantity of screws in the tightening parameter, displayed with the light indicators.
15	Final torque	Displays the value of the final torque of the tightening task.
16	Prevail torque	Displays the value of the prevail torque if the prevail torque function is enabled.
17	Rundown angle	Displays the value of the final rundown angle of the tightening task.
18	Tightening angle	Displays the tightening angle of the tightening stage.

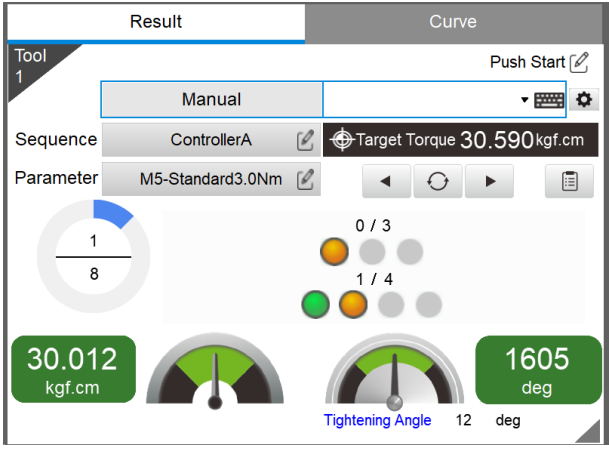
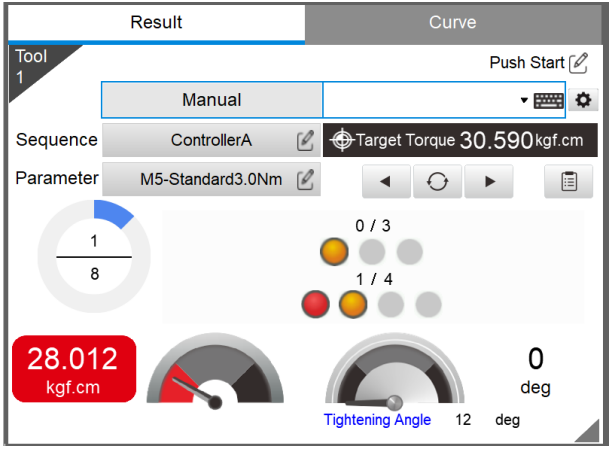
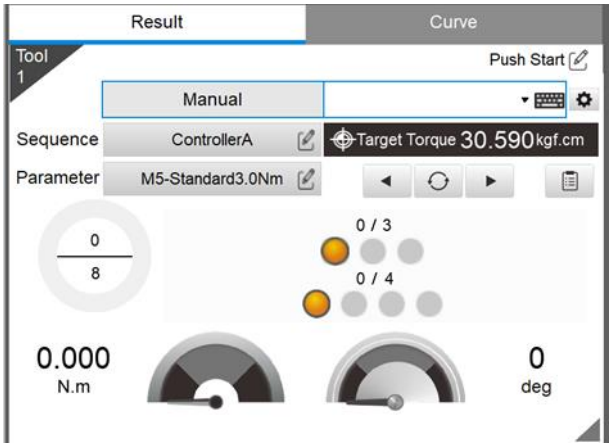
Code in the picture	Item	Description
19	Color of light indicators and meter	<p>Displays operation result status:</p> <p>Green: tightening OK</p> 
		<p>Red: tightening NOK</p> 
		<p>The light is yellow and the meter is gray: no tightening result or operation in progress</p> 

8

8

The Result page display changes depending on the Operation Mode you select.

A. Operation result screen in Single-tool operation mode:



B. Operation result screen in Dual-tool alternation mode:

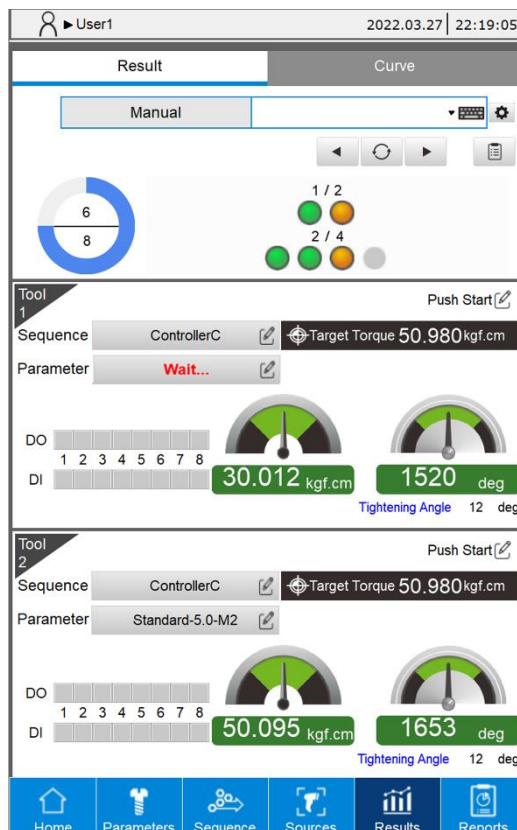

C. Operation result screen in Dual-tool Synchronization mode:

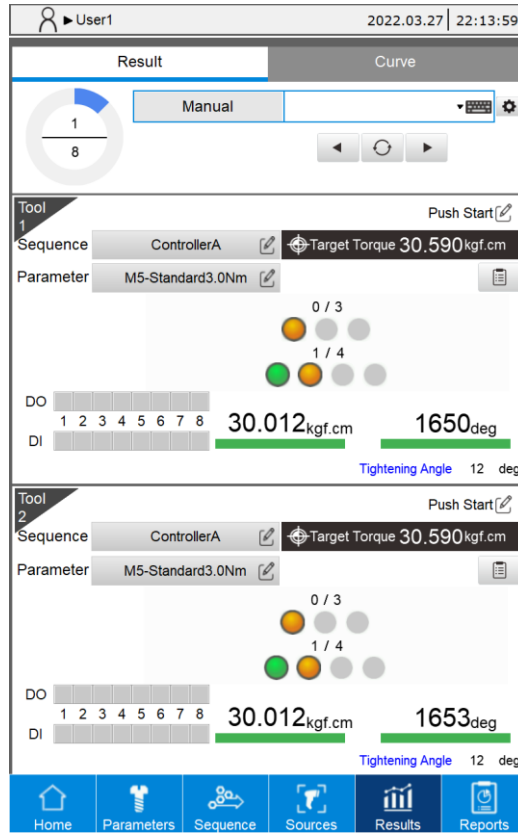



8.2 Curve (Operating curve)

The system provides the function of recording operating curves. The Curve page displays the tightening curve each time the tightening is complete. This curve displays the tightening results in an intuitive way and records the values (including angle, torque and time) at each stage of the tightening process. This allows the debugging personnel to fine-tune the key parameters according to the tightening results.

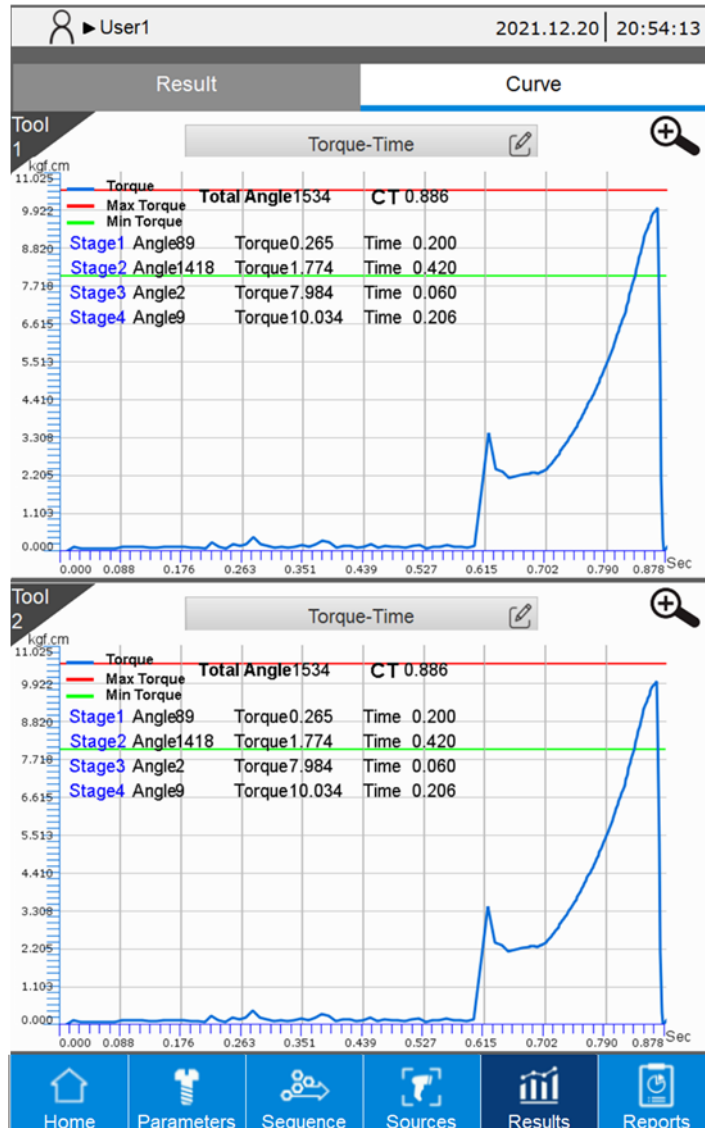

Controller

9

This chapter introduces the controller-related settings for the smart servo screwdriver system. The System Settings, DI/DO, Peripheral Device, Communication (Modbus), and Service Station are included.

9.1	System Settings	9-2
9.2	DI/DO	9-8
9.3	Peripheral device	9-9
9.4	Communication.....	9-12
9.5	Service Station	9-13

9.1 System Settings

9

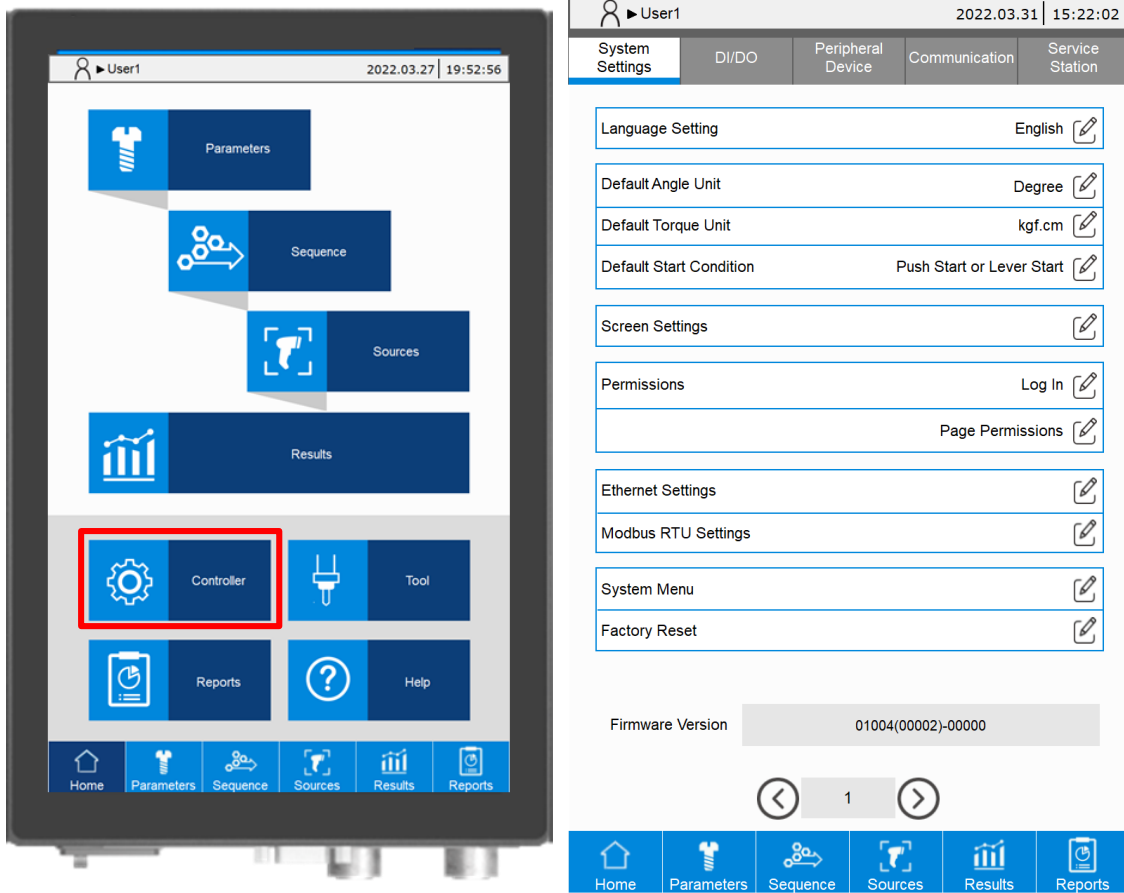

- 1. Language Setting: switch language. The available options are Traditional Chinese (繁體中文), Simplified Chinese (简体中文) and English.



2. Default Angle Unit: switch the angle unit to degrees or turns.

No.	Item
1	Degree
2	Turn
3	
4	
5	

3. Default Torque Unit: switch the torque unit to N.m, Kgf.cm, lbf.ft, or lbf.in.

No.	Item
1	N.m
2	Kgf.cm
3	lbf.ft
4	lbf.in
5	

4. Default Start Condition (of the tool): the available tool start conditions are as follows.

- Push Start (push the screwdriver down)
- DI
- Lever Start (press the lever button)
- Push Start or Lever Start
- Push Start and Lever Start

No.	Item
1	Push Start
2	DI
3	Lever Start
4	Push Start or Lever Start
5	Push Start and Lever Start

9

5. Screen Settings:

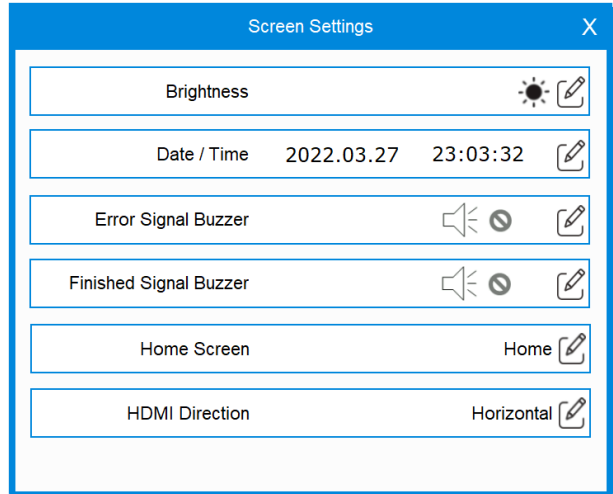

A. Brightness: adjusts the screen brightness.

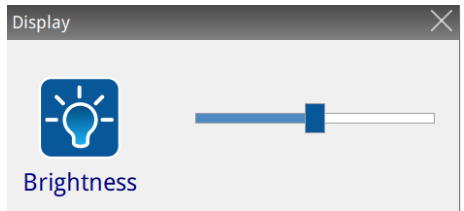

B. Date / Time: sets the date and time of the system.

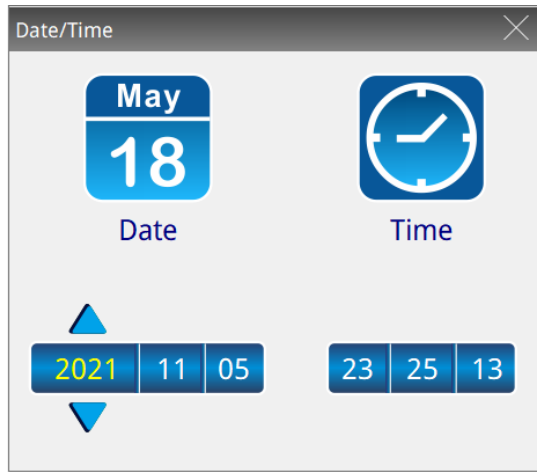

C. Error Signal Buzzer, Finished Signal Buzzer: sets the buzzer sound for the corresponding signal, shown as follows.

Diagram	Description
	Mute
	One long beep
	One short beep
	Two short beeps

D. Home Screen: specifies the Home screen at startup.

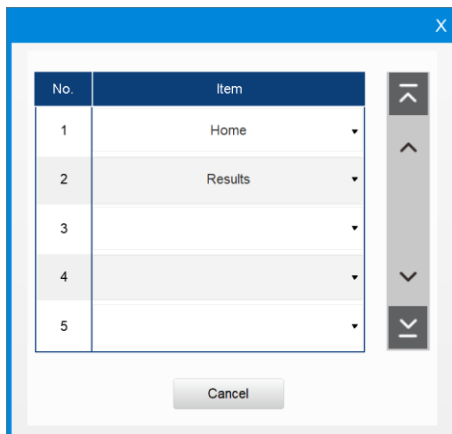

E. HDMI Direction: sets the external screen orientation when connecting through HDMI.

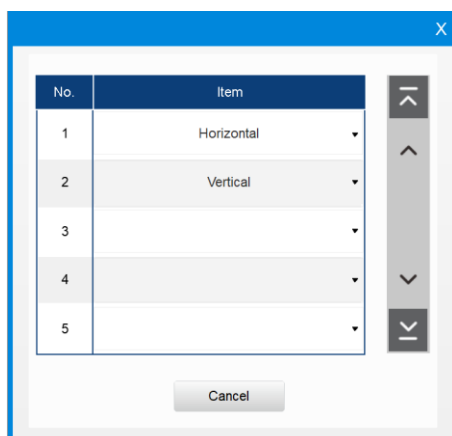

6. Permissions

A. Log In: you can log into accounts with different levels of permissions and change the account name (User) and password.

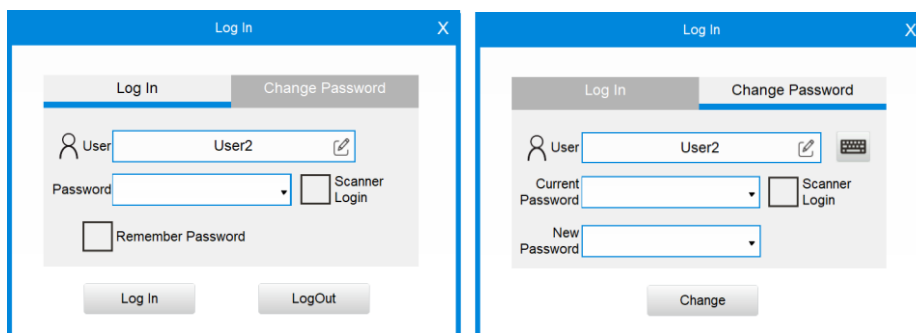

(1) Highest permissions: Admin has the highest permissions and can access and edit all pages of the controller system.

User: Admin

Default password: 99.

(2) Custom permissions: set the editing and access permissions for each account.

User: User1 – User5.

Default password: User1 password is 1, User2 password is 2...and so on.

- B. Page permissions: when logged in as Admin, you can modify the items that can be accessed and edited by all other permission levels.

9

User	User1	User2	User3	User4	User5	Admin
Parameter:	<input checked="" type="checkbox"/>	<input checked="" type="checkbox"/>	<input checked="" type="checkbox"/>	<input checked="" type="checkbox"/>	<input checked="" type="checkbox"/>	<input checked="" type="checkbox"/>
Sequence:	<input checked="" type="checkbox"/>	<input checked="" type="checkbox"/>	<input checked="" type="checkbox"/>	<input checked="" type="checkbox"/>	<input checked="" type="checkbox"/>	<input checked="" type="checkbox"/>
Sources:	<input checked="" type="checkbox"/>	<input checked="" type="checkbox"/>	<input checked="" type="checkbox"/>	<input checked="" type="checkbox"/>	<input checked="" type="checkbox"/>	<input checked="" type="checkbox"/>
Controller:	<input checked="" type="checkbox"/>	<input checked="" type="checkbox"/>	<input checked="" type="checkbox"/>	<input checked="" type="checkbox"/>	<input checked="" type="checkbox"/>	<input checked="" type="checkbox"/>
Tool:	<input checked="" type="checkbox"/>	<input checked="" type="checkbox"/>	<input checked="" type="checkbox"/>	<input checked="" type="checkbox"/>	<input checked="" type="checkbox"/>	<input checked="" type="checkbox"/>
Operate the screw progress:	<input checked="" type="checkbox"/>	<input checked="" type="checkbox"/>	<input checked="" type="checkbox"/>	<input checked="" type="checkbox"/>	<input checked="" type="checkbox"/>	<input checked="" type="checkbox"/>
Delete Production Report:	<input checked="" type="checkbox"/>	<input checked="" type="checkbox"/>	<input checked="" type="checkbox"/>	<input checked="" type="checkbox"/>	<input checked="" type="checkbox"/>	<input checked="" type="checkbox"/>
Delete Error/Warning Report:	<input checked="" type="checkbox"/>	<input checked="" type="checkbox"/>	<input checked="" type="checkbox"/>	<input checked="" type="checkbox"/>	<input checked="" type="checkbox"/>	<input checked="" type="checkbox"/>

For users without permissions on certain functions, the screen shows prohibition symbols on the corresponding icons.



- 7. Ethernet Settings: you can set the network IP address of the smart servo screwdriver system. The default is 192.168.1.11.

Note: Modbus TCP Slave (Port: 502), VNC (Port: 5900), FTP (Port: 21).

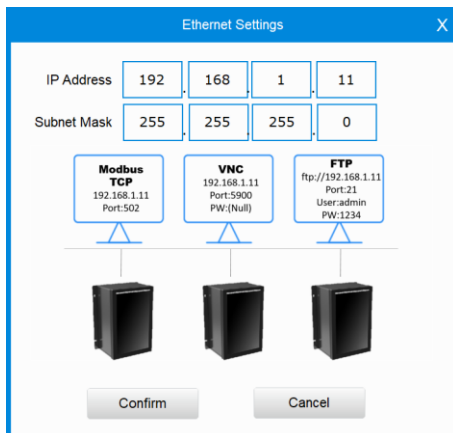

- 8. Modbus RTU Settings: you can set the RS485 parameters.

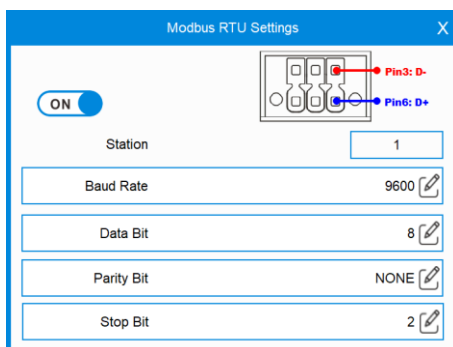

- 9. System Menu: switches to the BIOS system menu of the controller.

Note: operation by professional personnel is recommended.

- 10. Factory Reset: clears all settings while restores the network IP address to the default.

Note: if you use the highest permissions account to restore factory settings, passwords for all accounts are reset to the default, and the network IP is restored to the default setting.

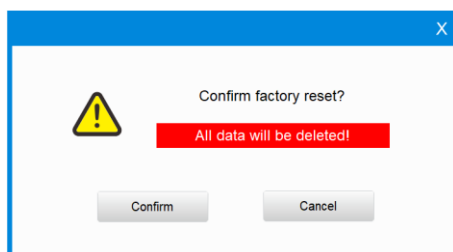





- 11. Firmware version: provides the firmware version of the smart servo screwdriver system, for example: 01000-01000.

9.2 DI/DO

9



1. Digital Output (DO) setting: sets the output functions of DO1 - DO8, which can be designated as NO (normally open)  or NC (normally closed) .
2. Digital Input (DI) setting: sets the input functions of DI1 - DI8, which can be designated as NO (normally open)  or NC (normally closed) .

DO functions	Function code	DI functions
Ready	01	Start Tightening
Running	02	Start Loosening
Tightening OK	03	Emergency Stop
Tightening NOK	04	Clear Error
Loosening OK	05	Reset Total Screw Quantity
Loosening NOK	06	Next Step
Total Screw Quantity Reached	07	Previous Step
Reserved	08	Start Tightening (Pulse Signal)
Reserved	09	Start Tightening (Pulse Signal)
Reserved	10	Start Tightening (Dual-tool)
Reserved	11	Start Loosening (Dual-tool)
Reserved	12	Reserved
Reserved	13	Reserved
Reserved	14	Reserved
Reserved	15	Reserved
Bit ID Output Bit 1 - 8	16-23	Bit ID Input Bit 1 - 8
Parameter ID Output Bit 1 - 8	24-31	Parameter ID Input Bit 1 - 8
Screw Progress Output Bit 1 - 8	32-39	Screw Progress Input Bit 1 - 8
Sequence ID Output Bit 1 - 8	40-47	Sequence ID Input Bit 1 - 8

9.3 Peripheral Device



There are two types of digital IO modes:

- Use DO signals to output the operation status to the peripheral equipment. You must first set the following DO functions (refer to Section 9.2):
Bit ID Output Bit 1 - 8, Parameter ID Output Bit 1 - 8, Screw Progress Output Bit 1 - 8, and Sequence ID output Bit 1 - 8.
- Use DI signals to obtain the peripheral device signals. You must first set the following DI function (refer to Section 9.2):
Bit ID input Bit 1 - 8.

9

1. Bit ID

A. Bit ID Output Table: by referring to the table, the system converts the bit running status into a binary value, and then outputs with the DO signal.

Example:

- (1) When the Bit ID is 1: query the Bit ID Output Table, and b0000001(1) is the corresponding binary value for “Bit ID Output Bit 1 - 8”.
- (2) When the Bit ID is 2: query the Bit ID Output Table, and b0000010(2) is the corresponding binary value for “Bit ID Output Bit 1 - 8”.

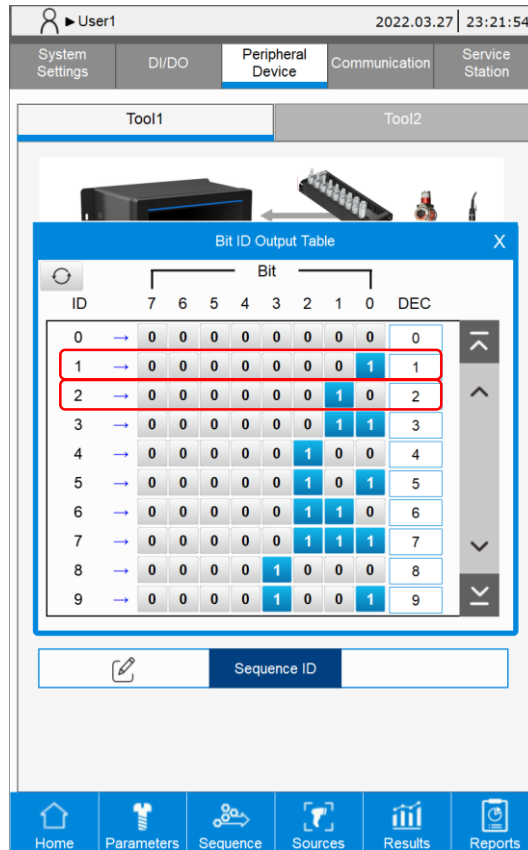

B. Bit ID Input Table: input with the DI signal, and by referring to the table, the system converts the decimal Bit ID input into the bit running status.

Example:

- (1) When the “Bit ID input Bit 1 - 8” is b00000001(1): query the Input Table, and its corresponding Bit ID = 1.
- (2) When the “Bit ID input Bit 1 - 8” is b00000010(2): query the Input Table, and its corresponding Bit ID = 2.

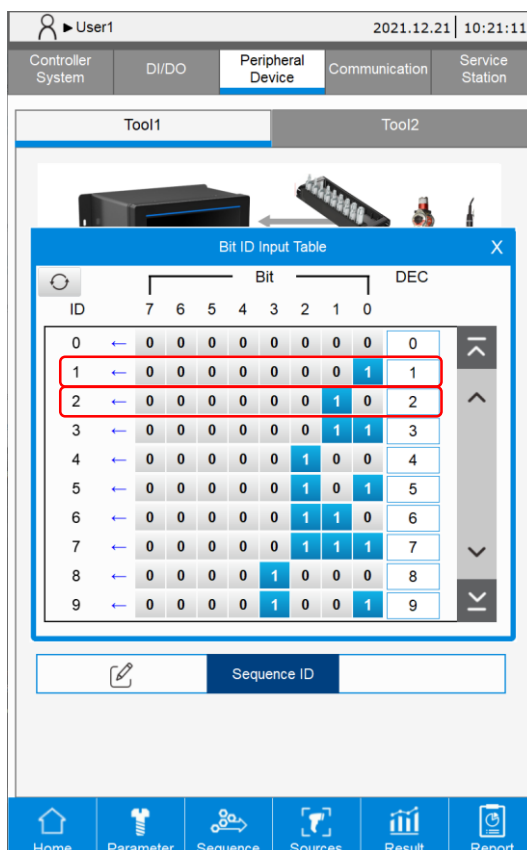

2. Parameter ID

Output Conversion Table: by referring to the table, the system converts the tightening parameter running status into a binary value, and then outputs the value with the DO signal.

3. Screw Progress

Output Conversion Table: by referring to the table, the system converts the screw progress running status into a binary value, and then outputs the value with the DO signal.

4. Sequence ID

Output Conversion Table: by referring to the table, the system converts the tightening sequence running status into a binary value, and then outputs the value with the DO signal.

9

9.4 Communication

The smart servo screwdriver system provides a Modbus TCP communication interface, which allows users to remotely monitor and operate the system. The system has pre-defined Modbus handshaking communication addresses, so users can use the address table through communication to control the screwdriver system.

The following provides the test pages of this handshaking communication. This makes it convenient for engineers to debug during communication testing. For an overview of the Modbus TCP communication interface, refer to CH12 Modbus Communication. For detailed function codes description of Modbus communication, refer to Appendix A.

There are 8 tabs which you can switch with the arrows in this page.

1. The first tab Status displays the real-time system status updates.
2. The other seven tabs correspond to the seven main functions of the system: Parameters, Sequence, Sources, Results, Controller, Tool, and Reports. These tabs display the respective functions and their handshaking operations.

Note: the default IP of the Modbus TCP Server of the servo screwdriver system is: 192.168.1.11; Port: 502.

9.5 Service Station

This screen displays the currently running parameters of Tool 1 and Tool 2, so that the personnel can identify the related operations.

9

User1
2022.03.27 | 23:31:08

System Settings
DI/DO
Peripheral Device
Communication
Service Station

Tool1
Tool2

General	Stage 1-6					Stage 7-8		
1	5	21	21	17	0	0	37	33
0	0	0	0	0	0	0	0	0
0	50	750	2400	3000	0	0	0	0
0	80	500	200	100	0	0	100	500
0	90	1080	0	10	0	0	100	3600
0	0	0	50	10	0	0	0	0
1	10	10	10	1000	0	0	10	10
0	0	0	0	0	0	0	0	0
1	0	0	0	0	0	0	0	0
0	0	0	0	0	0	0	0	0
0	0	0	0	0	0	0	0	0
12	0	0	0	0	0	0	0	0
12	0	0	0	0	0	0	0	0
0	0	0	0	0	0	0	0	0
0	0	0	0	0	0	0	0	0
0	0	0	0	0	0	0	0	0
0	0	0	0	0	0	0	0	0
0	0	0	0	0	0	0	0	0
0	0	0	0	0	0	0	0	0
0	0	0	0	0	0	0	0	0
0	0	0	0	0	0	0	0	0
0	0	0	0	0	0	0	0	0
0	0	0	0	0	0	0	0	0
0	6000	6000	6000	6000	0	0	6000	6000
0	0	0	0	0	0	0	0	0
100	0	0	0	0	0	0	0	0
32787	9999	9999	9999	9999	0	0	9999	9999
0	0	0	0	0	0	0	0	0
0	9999	9999	9999	9999	0	0	9999	9999
0	1800	9600	100	360	0	0	9999	9999
0	0	0	0	0	0	0	0	0
0	9999	9999	9999	9999	0	0	9999	9999
0	0	0	0	0	0	0	0	0
0	250	600	1000	3150	0	0	6000	6000
0	0	0	0	2850	0	0	0	0
100	0	0	0	0	0	0	0	0
32787	9999	9999	9999	9999	0	0	9999	9999
0	9999	9999	9999	9999	0	0	9999	9999
0	0	0	0	0	0	0	0	0
0	0	0	0	0	0	0	0	0
0	9999	9999	9999	9999	0	0	9999	9999
0	0	0	0	0	0	0	0	0
0	100	1000	500	200	0	0	200	200
0	0	0	0	0	0	0	0	0
0	0	0	0	0	0	0	0	0
0	0	0	0	0	0	0	0	0
0	0	0	0	0	0	0	0	0
0	0	0	0	0	0	0	0	0
0	0	0	0	0	0	0	0	0
0	0	0	0	4	0	0	0	0
0	0	0	0	1	0	0	0	0
0	0	0	0	0	0	0	0	0
0	10	20	30	40	0	0	90	91

⏪ 1 ⏩

Home
Parameters
Sequence
Sources
Results
Reports

(This page is intentionally left blank.)

9

Tool

10

This chapter introduces the information on the Tool screen for the smart servo screwdriver system. Tabs of the Tool Info, Tool Settings, LED Light Settings, and Tool Calibration are included.

10.1	Tool Info.....	10-2
10.2	Tool Settings.....	10-3
10.3	LED Light Settings	10-5
10.4	Tool Calibration	10-6

10.1 Tool Info

10

The screenshot displays the 'Tool Info' screen of the ST1 Series control interface. The interface is divided into two main sections: a menu on the left and a data display on the right. The menu includes options like Parameters, Sequence, Sources, Results, Controller, Tool (highlighted with a red box), Reports, and Help. The data display shows fields for Model Name (ECM-SD3-F50S0), Max. Speed (700rpm), Max. Torque (50.000kgf.cm), Tool Temperature (24°C), Service Reminder (OFF), and Tightening+Loosening Count (2 > 250000).

1. Tool information: displays Model Name, Max. Speed, and Max. Torque of the currently used servo screwdriver.
2. Tool Temperature: displays the current temperature of the servo screwdriver.
3. Tightening+Loosening Count: displays the tightening and loosening count of the servo screwdriver.

If the Service Reminder is enabled, when the tightening and loosening count is greater than the count suggested for servicing, the system prompts you to send the servo screwdriver back for factory repair and precision calibration.

10.2 Tool Settings

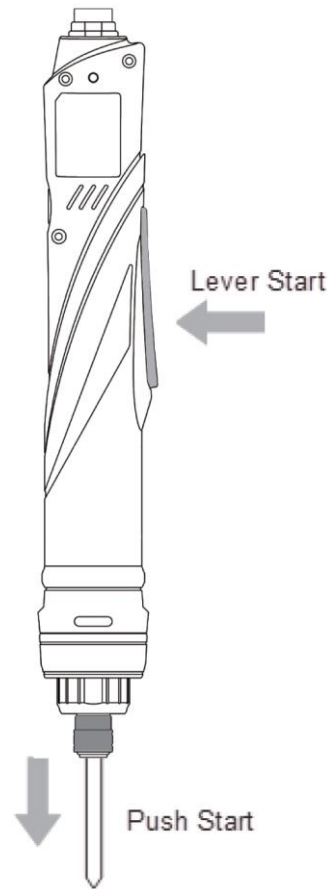
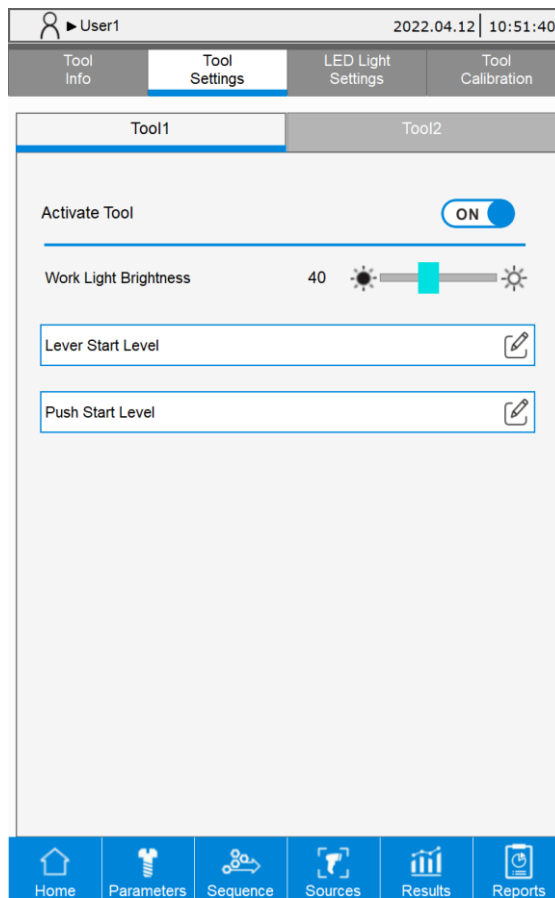



10

1. **Activate Tool:** activates the servo screwdriver. Once the tool is activated, you can operate its related functions.
2. **Work Light Brightness:** adjusts the brightness of the servo screwdriver work light. (0: means off; 100: means the maximum brightness).
3. **Lever Start Level:** adjusts the signal threshold for the servo screwdriver's lever button press action, so the ON/OFF signal for Lever Start can be effectively identified.
4. **Push Start Level:** adjusts the signal threshold for the servo screwdriver's push start action, so the ON/OFF signal for Push Start can be effectively identified.

Start condition	Signal ON	Signal OFF
Lever Start		
	Adjust the ON level (red) to be higher than the current state (black)	Adjust the OFF level (green) to be lower than the current state (black)

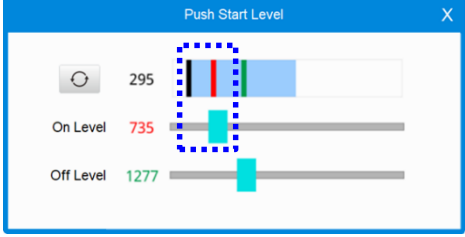
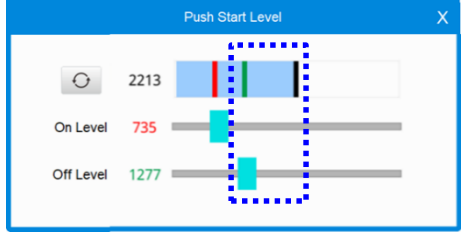
10

Start condition	Signal ON	Signal OFF
Push Start	 <p data-bbox="395 495 855 548">Adjust the ON level (red) to be higher than the current state (black)</p>	 <p data-bbox="900 495 1340 548">Adjust the OFF level (green) to be lower than the current state (black)</p>

Note: the **Reset** button  is for resetting the highest (black in current state of ON) and the lowest (black in current state of OFF) thresholds of the blue bar.

10.3 LED Light Settings

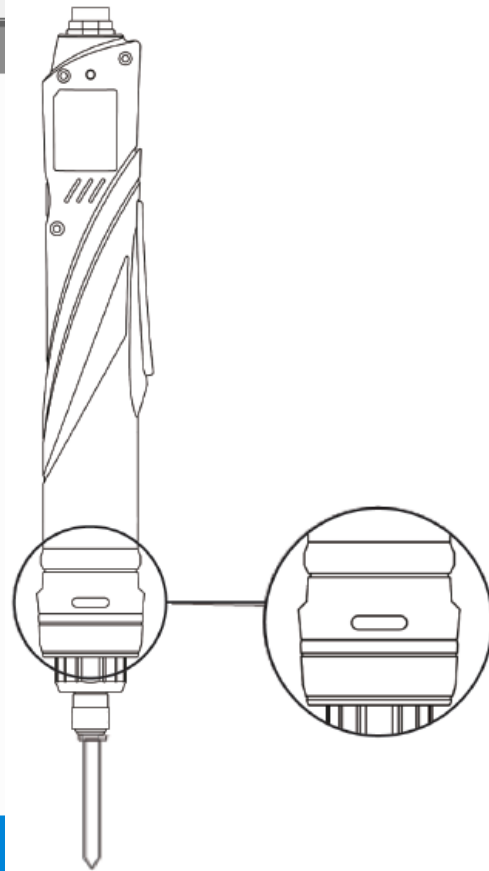
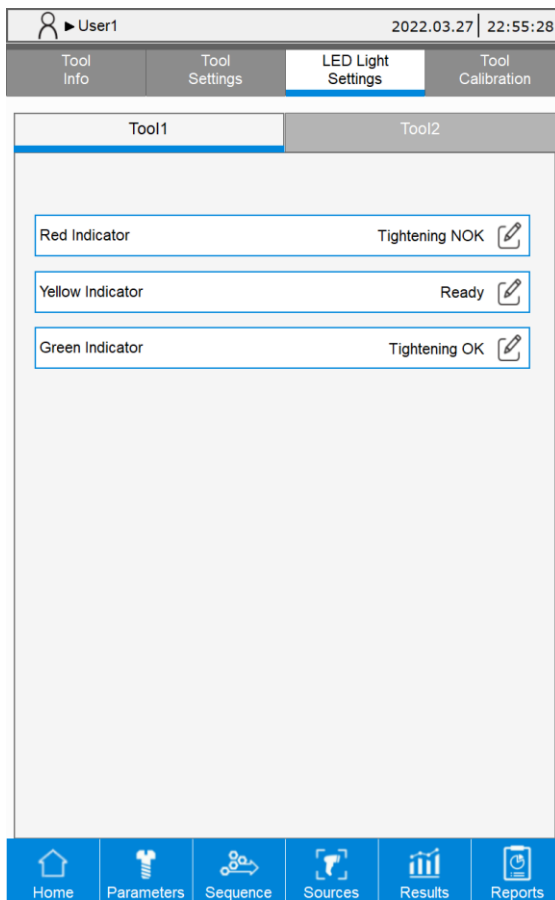

10

Tool LED Light Settings: you can set the status display of the red, yellow, and green lights respectively. The three lights cannot all be on simultaneously. When the three lights receive signals at the same time, the red light goes on first, the yellow light second, and the green light last.

The configurable options for the status of light indicators are as follows:

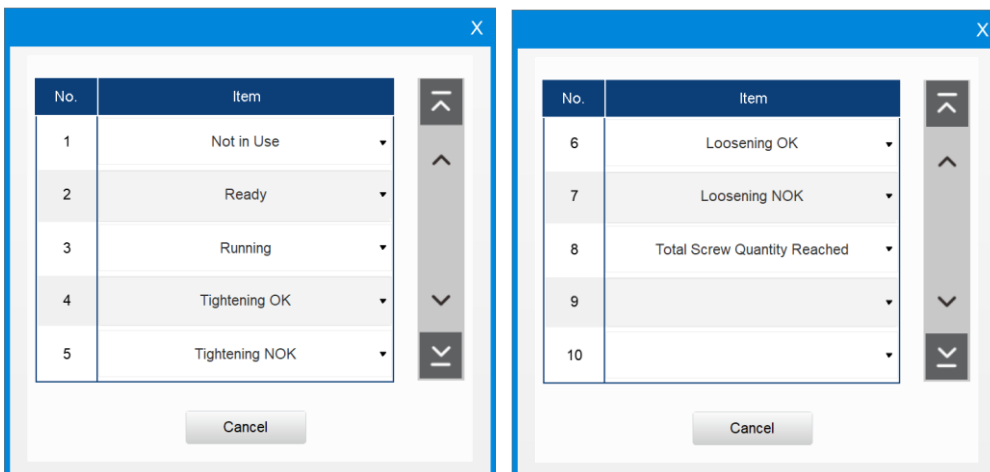

10

10.4 Tool Calibration

You can use the Tool Calibration page along with a third-party calibration instrument to calibrate the torque of the servo screwdriver and adjust its precision parameters.

Set a tightening parameter and set its strategy as Enhanced for the controller. Use this parameter to operate the servo screwdriver and the third-party calibration device for tightening. Once you completed the above steps, the controller screen displays the final torque for the tightening task. Then manually input the torque value measured by the external device (third-party calibration instrument feedback value), press **Save**, and the system automatically converts and exports a servo screwdriver torque parameter value. Press **Confirm** to complete the calibration procedure.

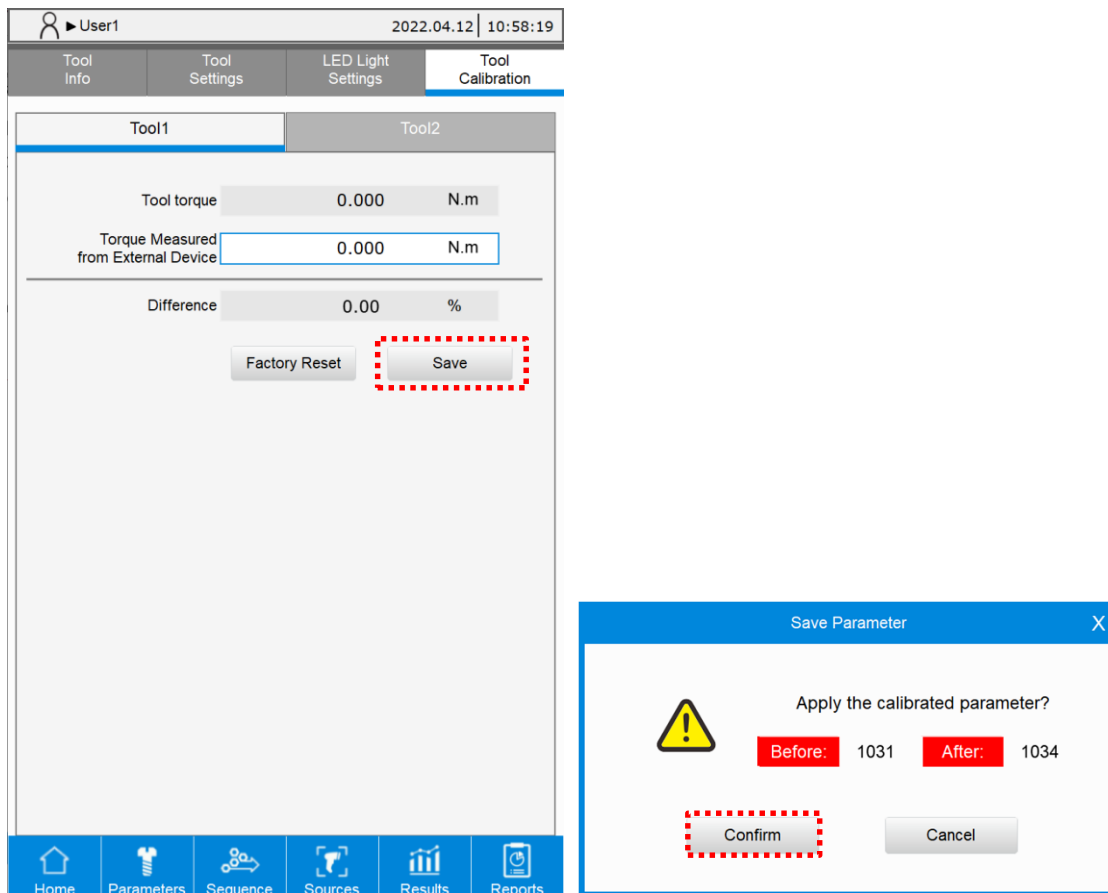

Reports

This chapter introduces the Reports screen, which includes tabs of Production Report, Error Report, and Warning Report.

11.1	Production Report	11-2
11.2	Error Report.....	11-3
11.3	Warning Report	11-4

11

11.1 Production Report

The system displays the tightening information of each tightening task on the Production Report page with up to 200,000 entries. Once 200,000 entries are reached, the system automatically overwrites the first entry. In addition, you can export the report data in excel format to view the historical data.



Click on each row (entry) of the report records to view details of the tightening results and the operating curve graph.

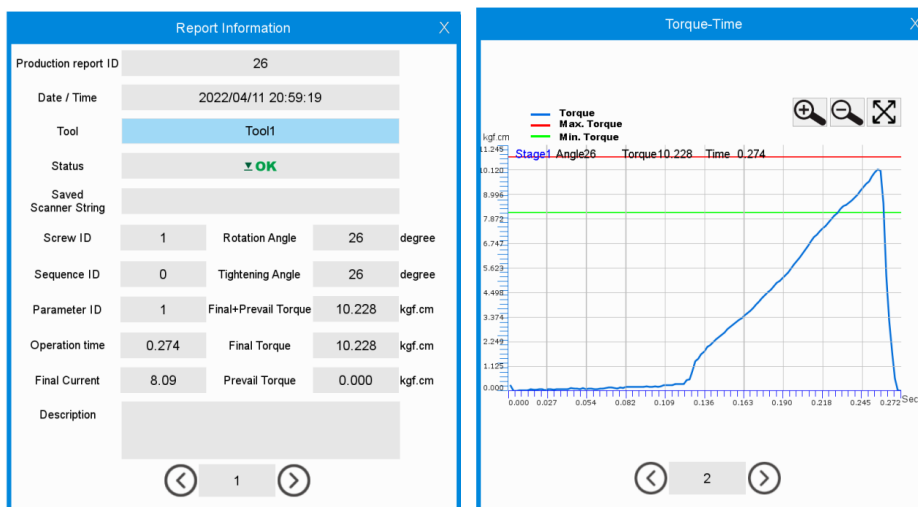

11.2 Error Report

In the Error Report, you can view the error records. By analyzing and reviewing the data on the frequently occurred errors, you can improve the quality control and production efficiency. Click on the row of the error records to view its detailed information.

11

The screenshot displays the 'Error Report' section of a software interface. At the top, it shows the user 'User1' and the date/time '2022.04.28 | 18:36'. Below this are navigation tabs for 'Production Report', 'Error Report', 'Warning Report', and 'Button Report'. The 'Error Report' tab is active, showing a table with three columns: 'Date / Time', 'Error Code', and 'Description'. The table contains three entries, all with the error code 'NG2002' and the description 'Tightening signal ends too early'. A red prohibition sign is visible in the top right corner of the table area. Below the table is a pagination control showing '6' records. At the bottom of the interface is a navigation bar with icons for Home, Parameters, Sequence, Sources, Results, and Reports. An 'Error Detail' dialog box is open on the right, showing the error code 'NG2002' and the description 'Tightening signal ends too early'. The dialog also provides a 'Condition', 'Cause', 'Checking method', and 'How to clear?' for the error.

Date / Time	Error Code	Description
2022/04/28 14:56:41	NG2002	Tightening signal ends too early
2022/04/28 14:57:14	NG2002	Tightening signal ends too early
2022/04/28 14:57:16	NG2002	Tightening signal ends too early

Error Detail

 Tool2 NG2002

Tightening signal ends too early

Condition: during the tightening process, the tightening signal disappears.
Cause:
1. During the tightening process, the electric screwdriver is withdrawn early.
2. Transmission of the tightening DI signal is poor.
Checking method:
1. After tightening is complete, turn off the tightening signal.
2. Use the DO signal to activate the tightening and check if the tightening signal transmission is poor.
3. Perform Push Start to check if the signal wire of Push Start has a poor contact.
4. Perform Lever Start to check if signal wire of Lever Start has a poor contact.
How to clear?
Unscrew and then re-tighten the screw.

11.3 Warning Report

In the Warning Report, all warnings for the operations are recorded. This report can be used to avoid misoperations and thus improves the operation efficiency. Click on the row of the warning records to view its detailed information.

The screenshot shows the 'Warning Report' interface. At the top, it displays 'User1' and the date/time '2022.04.28 18:37'. Below this is a navigation bar with four tabs: 'Production Report', 'Error Report', 'Warning Report' (which is selected), and 'Button Report'. A trash icon is visible on the left. The main area contains a table with the following data:

Date / Time	Warning Code	Description
2022/04/19 16:46:07	WN1053	Screw quantity reached. Tightening prohibited.
1970/01/01 00:00:00	WN1053	Screw quantity reached. Tightening prohibited.
2022/04/20 11:07:53	WN1053	Screw quantity reached. Tightening prohibited.
2022/04/26 17:41:43	WN1055	Incorrect parameter setting. Tightening prohibited.
1970/01/01 00:00:00	WN2003	Parameters not set!

Below the table is a pagination control showing '1' between left and right arrows. At the bottom is a navigation bar with icons for 'Home', 'Parameters', 'Sequence', 'Sources', 'Results', and 'Report'. To the right, a 'Warning Detail' pop-up window is shown for the warning with code 'WN2003' and description 'Parameters not set!'. The pop-up includes a warning icon and the following text:

Warning Detail

Tool2 WN2003

Parameters not set!

Condition: the parameter configuration is incomplete.
 Cause:
 1. The tightening source is not configured.
 2. The parameter configuration is not complete when the electric screwdriver starts to run.
 Checking method:
 1. Check whether the parameters of the tightening source are configured.
 2. Confirm that the ready signal is on, and then start tightening.
 How to clear?
 Restart the tightening operation.

11.4 Button Report

Production Report		Error Report	Warning Report	Button Report
<div style="display: flex; justify-content: space-between;"> User1 2022.04.28 18:36 </div>				
Date / Time	Button ID	User	Before	After
2022/04/19 16:31:14	4000	User1	0	1
2022/04/19 16:45:55	4000	User1	0	1
2022/04/20 19:44:26	4000	User1	0	1
2022/04/20 20:03:58	7000	User1	0	1
2022/04/21 11:42:38	4002	User1	0	1
2022/04/21 11:42:39	4002	User1	0	1
2022/04/21 11:42:40	4002	User1	0	1
2022/04/21 11:42:43	4002	User1	0	1
2022/04/25 11:38:13	4000	User1	0	1
2022/04/25 20:34:22	7000	User1	0	1

< 1 >

Home
Parameters
Sequence
Sources
Results
Report

11

Modbus communications 12

This chapter introduces the Modbus TCP and Modbus RTU communication interfaces provided by the servo screw tightening controller. You can remotely operate the screen through these interfaces. For detailed function code descriptions of Modbus communications, refer to Appendix A.

12.1	System structure.....	12-2
12.2	Operational status of the smart servo screwdriver system	12-3
12.3	Handshake data of the smart servo screwdriver system	12-6
12.4	Examples of tightening parameter operations.....	12-8
	#100 Write the parameters	12-8
	#150 Read the parameters	12-9

12

12.1 System structure

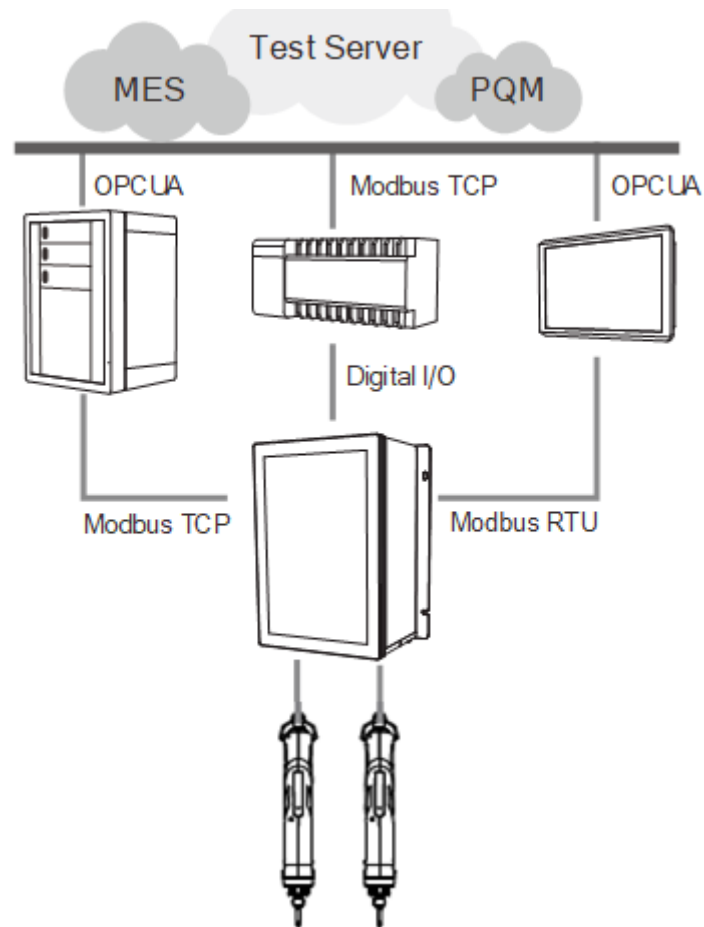

The smart servo screwdriver system provides two communication protocols: Modbus TCP (Ethernet) and Modbus RTU (RS485). These protocols allow peripheral IIoT equipment to obtain information from the controller, and then collect data to construct host computer systems, such as MES and PQM. The connection between the IIoT equipment and the smart servo screwdriver system is not limited by the hardware platform. Therefore, any equipment that supports Modbus protocol (such as PC, PLC, or HMI) is able to control the screwdriver system and obtain tightening data through the controller-defined Modbus handshake address table.

The Modbus handshake table consists of:

1. Operational status of the smart servo screwdriver system.
2. Handshake data of the smart servo screwdriver system.

Caution:

1. Choose either Modbus TCP Slave or Modbus RTU Slave. Both use the same Modbus handshake addresses.
2. The Modbus address table in this manual must match the firmware version of the servo screwdriver system after 0031-0031-8097 (inclusive).

12.2 Operational status of the smart servo screwdriver system

Obtain real-time information of the smart servo screwdriver system from the operational status area. The data refresh rate is 0.3 seconds. Refer to the following Modbus address table.

Modbus (Hex)	Tool 1 status	R/W	Modbus (Hex)	Tool 1 status	R/W
0	Tightening ID set for cur. switch method	R	19	Clear the flag	W
1	PAR/SEQ set for cur. switch method	R	1A	Total screw Qty. of current sequence (L)	R
2	SEQ ID of current switching method	R	1B	Total screw Qty. of current sequence (H)	R
3	PAR ID of current switching method	R	1C	Parameter Qty. of current sequence	R
4	Current target torque	R	1D	Screw Qty. of current parameter (L)	R
5	Current target angle	R	1E	Screw Qty. of current parameter (H)	R
6	Current parameter progress	R	1F	All screws of current parameter finished	R/W
7	Screw progress of current parameter (L)	R	20	Current parameter finished	R/W
8	Screw progress of current parameter (H)	R	21	Current screw finished	R/W
9	Screw progress of current sequence (L)	R	22	Setting parameters (Waiting...)	R
A	Screw progress of current sequence (H)	R	23	Final + Prevail torque	R
B	Tightening OK count (L)	R	24	Actual angle / total rundown angle	R
C	Tightening OK count (H)	R	25	Tightening angle	R
D	Single screw tightening NOK count (L)	R	26	Tightening result (1: OK; 2: NOK; 5: Pass)	R
E	Single screw tightening NOK count (H)	R	27	Loosening result (1: OK; 2: NOK)	R
F	Loosening OK count (L)	R	28	Curve creation finished	R/W
10	Loosening OK count (H)	R	29	Restrict tightening status	R
11	Single screw loosening NOK count (L)	R	2A	Parameter settings OK / NOK	R
12	Single screw loosening NOK count (H)	R	2B	Final torque	R
13	Final stage max. torque	R	2C	Prevail torque	R
14	Final stage min. torque	R	2D	Final current	R
15	Current torque unit	R	2E	Cause to restrict tightening operation	R
16	-	-	2F	Cause to restrict loosening operation	R
17	-	-	30	-	-
18	-	-	31	-	-

12

Modbus (Hex)	Tool 2 status	R/W	Modbus (Hex)	Tool 2 status	R/W
32	Tightening ID set for cur. switch method	R	4B	Clear the flag	W
33	PAR/SEQ set for cur. switch method	R	4C	Total screw Qty. of current sequence (L)	R
34	SEQ ID of current switching method	R	4D	Total screw Qty. of current sequence (H)	R
35	PAR ID of current switching method	R	4E	Parameter Qty. of current sequence	R
36	Current target torque	R	4F	Screw Qty. of current parameter (L)	R
37	Current target angle	R	50	Screw Qty. of current parameter (H)	R
38	Current parameter progress	R	51	All screws of current parameter finished	R/W
39	Screw progress of current parameter (L)	R	52	Current parameter finished	R/W
3A	Screw progress of current parameter (H)	R	53	Current screw finished	R/W
3B	Screw progress of current sequence (L)	R	54	Setting parameters (Waiting...)	R
3C	Screw progress of current sequence (H)	R	55	Final + Prevail torque	R
3D	Tightening OK count (L)	R	56	Actual angle / total rundown angle	R
3E	Tightening OK count (H)	R	57	Tightening angle	R
3F	Single screw tightening NOK count (L)	R	58	Tightening result (1: OK; 2: NOK; 5: Pass)	R
40	Single screw tightening NOK count (H)	R	59	Loosening result (1: OK; 2: NOK)	R
41	Loosening OK count (L)	R	5A	Curve creation finished	R/W
42	Loosening OK count (H)	R	5B	Restrict tightening status	R
43	Single screw loosening NOK count (L)	R	5C	Parameter settings OK / NOK	R
44	Single screw loosening NOK count (H)	R	5D	Final torque	R
45	Final stage max. torque	R	5E	Prevail torque	R
46	Final stage min. torque	R	5F	Final current	R
47	Current torque unit	R	60	Cause to restrict tightening operation	R
48	-	-	61	Cause to restrict loosening operation	R
49	-	-	62	-	-
4A	-	-	63	-	-

Modbus (Hex)	Tool 1 / Tool 2 common status	R/W	Modbus (Hex)	Tool 1 / Tool 2 common status	R/W
64	Tool 1 servo / operation error / warning ID	R	6F	Production report entry creation finished	R/W
65	Tool 2 servo / operation error / warning ID	R	70	Clear the common flag	W
66	DI status (Bit 1 - 8: Tool 1; Bit 9 - 16: Tool 2)	R	71	-	-
67	DO status (Bit 1 - 8: Tool 1; Bit 9 - 16: Tool 2)	R	72	All production report entries cleared	R/W
68	-	R	73	Start overwriting from production report ID 1	R/W
69	Current No. of error report entries	R	74	Start overwriting from error report ID 1	R/W
6A	Current No. of warning report entries	R	75	Start overwriting from warning report ID 1	R/W
6B	Current No. of production report entries (L)	R	76	Start overwriting from button report ID 1	R/W
6C	Current No. of production report entries (H)	R	77	Keepalive	R
6D	Current No. of button report entries (L)	R	78 to 95	-	-
6E	Current No. of button report entries (H)	R	-	-	-

12

12.3 Handshake data of the smart servo screwdriver system

You can operate all functions of the controller with the function code table through handshaking.

The list of all function codes is as follows:

Parameters			
Function code	Function name	Function code	Function name
#100	Write the parameters	#150	Read the parameters
Sequence			
Function code	Function name	Function code	Function name
#200	Write the sequence	#250	Read the sequence
Sources			
Function code	Function name	Function code	Function name
#300	Write the operation mode and switching method of Sources	#350	Read the operation mode and switching method of Sources
#301	Write the contents of single source settings	#351	Read the contents of single source settings
Results			
Function code	Function name	Function code	Function name
#400	Write the switching method of Sources	#450	Read the switching method of Sources
#401	Write the scanner string	#451	Read the scanner string
#402	Write to clear all errors	#452	Read the scanner advanced settings
#403	Write to reset the operation progress	-	-
#404	Write to execute the previous step	-	-
#405	Write to execute the next step	-	-
#406	Write to restrict tightening operation	-	-
#407	Write to restrict loosening operation	-	-
#408	Write the scanner advanced settings	-	-

12

Controller

Function code	Function name	Function code	Function name
#500	Write the request for permissions login	#550	Read the Ethernet settings
#501	Write the request for password change	#551	Read the page permissions
#502	Write the request for permissions logout	#552	Read the firmware version
#503	Write the page permissions	#553	Read the DI/DO functions
#504	Write the Ethernet settings	#554	Read the DI/DO conversion table
#505	Request for factory reset	#555	Read the default torque unit
#506	Write the buzzer sound pattern	#556	Read the default tool start condition
#507	Write the DI/DO functions	-	-
#508	Write the DI/DO conversion table	-	-
#509	Write the default torque unit	-	-
#510	Write the default tool start condition	-	-

Tool

Function code	Function name	Function code	Function name
#600	Write to activate the tool	#650	Read the tool information
#601	Write to enable service reminder	#651	Read the lever start level
#602	Write the lever start level	#652	Read the push start level
#603	Write the push start level	#653	Read the work light brightness
#604	Write the work light brightness	#654	Reserved
#605	Reserved	#655	Read the LED light settings
#606	Write the LED light settings	#656	Read the tool calibration
#607	Write the tool calibration	-	-

Reports

#700	Clear the production report entries	#750	Find and read the production report entries
#701	Clear the error and warning report entries	#751	Find and read curves
-	-	#752	Find and read the error report entries
-	-	#753	Find and read the warning report entries

12.4 Examples of tightening parameter operations

#100 Write the parameters

Content description:

Use the function code #100 to set the tightening parameters.

- A. Add a tightening parameter.
- B. Modify an existing tightening parameter. First, read the parameters with function code #150. After modifying the parameters, write the parameters with function code #100.

Handshake signal description:

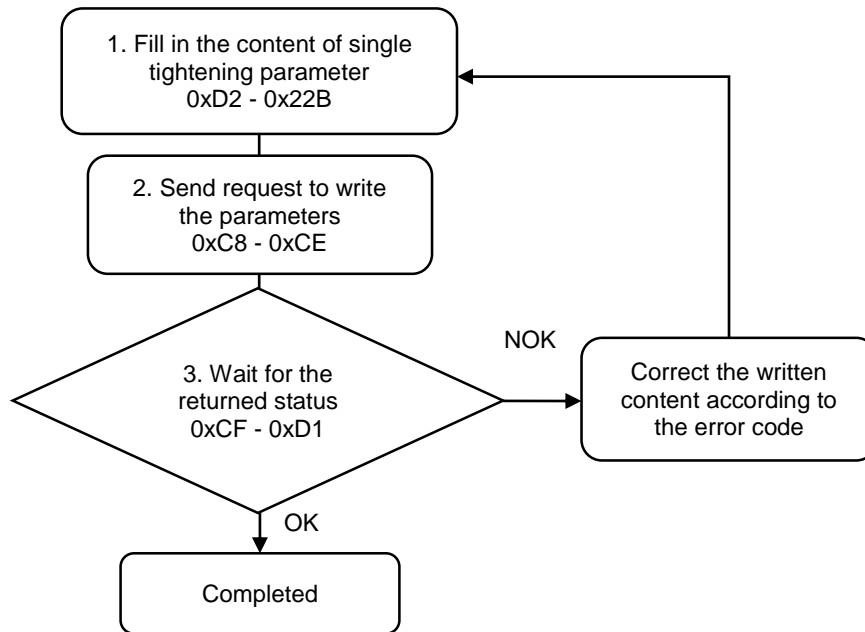

#150 Read the parameters

Content description:

Use function code #150 to read the tightening parameters.

- A. Obtain the content of existing tightening parameters.
- B. Check whether the tightening parameters have been set.

Handshake signal description:

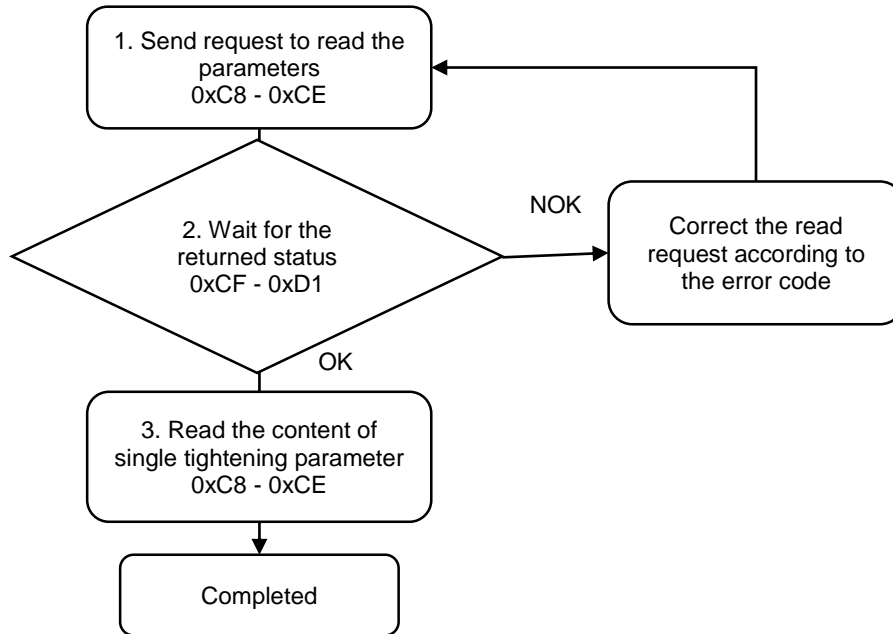

(This page is intentionally left blank.)

12

Troubleshooting

13

This chapter introduces the alarms and their troubleshooting methods. You can use this chapter to find the causes of alarms and handling methods.

13.1	Alarm list.....	13-2
13.1.1	Device alarms	13-2
13.1.2	Tightening errors	13-2
13.1.3	Operation warnings	13-6
13.2	Causes and corrective actions	13-7
13.2.1	Description of device alarms	13-7
13.2.2	Description of tightening errors	13-10
13.2.3	Description of operation warnings.....	13-35

13

Abnormality alarms come in three categories, namely “device alarms”, “tightening errors” and “operation warnings”. The definition of each is explained as follows:

Device alarms: the alarm messages for hardware signal and encoder signal, displayed as “ALnnnn”.

Tightening errors: the errors generated during tightening, displayed as “NGnnnn”.

Operation warnings: warning messages caused by improper operation, displayed as “WNnnnn”.

In the presentation of the alarms, the thousands digit represents Tool 1/Tool 2. If Tool 1 is abnormal, “AL1nnn” is displayed. If Tool 2 is abnormal, “AL2nnn” is displayed.

13.1 Alarm list

13.1.1 Device alarms

Alarm	Name
AL1001	Overcurrent
AL1004	Tool combination error
AL1006	Overload
AL1007	Excessive deviation of Speed command
AL1011	Encoder error
AL1013	Emergency stop
AL1036	Encoder alarm status error
AL1070	Encoder did not complete the read / write procedure
AL1087	Tool connection error
AL1099	Firmware error

Note: If you find an alarm not listed in the alarm list, contact your local distributor or technical staff.

13.1.2 Tightening errors

Alarm	Name
NG1000	Unknown parameter
NG1002	Tightening signal ends too early
NG1012	Tightening: exceeded max. rotation angle
NG1013	Tightening: timeout
NG1014	Tightening: exceeded tool max. current
NG1015	Tightening: error occurs during parameter setting
NG1032	Loosening: exceeded max. rotation angle
NG1033	Loosening: timeout
NG1034	Loosening: exceeded tool max. current
NG1035	Loosening: error occurs during parameter setting
NG1110	Start stage: operation error

Alarm	Name
NG1111	Start stage: exceeded the tool torque protection range Start stage: exceeded the tightening torque protection range
NG1112	Start stage: exceeded the operation time
NG1113	Start stage: insufficient operation time
NG1120	Start stage: exceeded tool max. current
NG1121	Start stage: lower than tool min. current
NG1122	Start stage: exceeded the max. angle
NG1123	Start stage: lower than the min. angle
NG1124	Start stage: exceeded the max. torque
NG1125	Start stage: lower than the min. torque
NG1210	Rundown stage: operation error
NG1211	Rundown stage: exceeded the tool torque protection range Rundown stage: exceeded the tightening torque protection range
NG1212	Rundown stage: exceeded the operation time
NG1213	Rundown stage: insufficient operation time
NG1220	Rundown stage: exceeded tool max. current
NG1221	Rundown stage: lower than tool min. current
NG1222	Rundown stage: exceeded the max. angle
NG1223	Rundown stage: lower than the min. angle
NG1224	Rundown stage: exceeded the max. torque
NG1225	Rundown stage: lower than the min. torque
NG1310	Pre-tightening stage: operation error
NG1311	Pre-tightening stage: exceeded the tool torque protection range Pre-tightening stage: exceeded the tightening torque protection range
NG1312	Pre-tightening stage: exceeded the operation time
NG1313	Pre-tightening stage: insufficient operation time
NG1320	Pre-tightening stage: exceeded tool max. current
NG1321	Pre-tightening stage: lower than tool min. current
NG1322	Pre-tightening stage: exceeded the max. angle
NG1323	Pre-tightening stage: lower than the min. angle
NG1324	Pre-tightening stage: exceeded the max. torque
NG1325	Pre-tightening stage: lower than the min. torque
NG1410	Tightening stage: operation error
NG1411	Tightening stage: exceeded the tool torque protection range
NG1412	Tightening stage: exceeded the operation time
NG1413	Tightening stage: insufficient operation time
NG1420	Tightening stage: exceeded tool max. current
NG1421	Tightening stage: lower than tool min. current
NG1422	Tightening stage: exceeded the max. angle
NG1423	Tightening stage: lower than the min. angle
NG1424	Tightening stage: exceeded the max. torque
NG1425	Tightening stage: lower than the min. torque

13

Alarm	Name
NG1510	Rundown stage (torque rate): operation error
NG1511	Rundown stage (torque rate): exceeded the tightening torque protection range
NG1512	Rundown stage (torque rate): exceeded the operation time
NG1513	Rundown stage (torque rate): insufficient operation time
NG1520	Rundown stage (torque rate): exceeded tool max. current
NG1521	Rundown stage (torque rate): lower than tool min. current
NG1522	Rundown stage (torque rate): exceeded the max. angle
NG1523	Rundown stage (torque rate): lower than the min. angle
NG1524	Rundown stage (torque rate): exceeded the max. torque
NG1525	Rundown stage (torque rate): lower than the min. torque
NG1881	Loosening stage: lower than the set torque
NG1891	Loosening stage: exceeded the tool torque protection range
NG1A10	Stage 1: operation error
NG1A11	Stage 1: exceeded the tightening torque protection range
NG1A12	Stage 1: exceeded the operation time
NG1A13	Stage 1: insufficient operation time
NG1A20	Stage 1: exceeded tool max. current
NG1A21	Stage 1: lower than tool min. current
NG1A22	Stage 1: exceeded the max. angle
NG1A23	Stage 1: lower than the min. angle
NG1A24	Stage 1: exceeded the max. torque
NG1A25	Stage 1: lower than the min. torque
NG1B10	Stage 2: operation error
NG1B11	Stage 2: exceeded the tightening torque protection range
NG1B12	Stage 2: exceeded the operation time
NG1B13	Stage 2: insufficient operation time
NG1B20	Stage 2: exceeded tool max. current
NG1B21	Stage 2: lower than tool min. current
NG1B22	Stage 2: exceeded the max. angle
NG1B23	Stage 2: lower than the min. angle
NG1B24	Stage 2: exceeded the max. torque
NG1B25	Stage 2: lower than the min. torque
NG1C10	Stage 3: operation error
NG1C11	Stage 3: exceeded the tightening torque protection range
NG1C12	Stage 3: exceeded the operation time
NG1C13	Stage 3: insufficient operation time
NG1C20	Stage 3: exceeded tool max. current
NG1C21	Stage 3: lower than tool min. current
NG1C22	Stage 3: exceeded the max. angle
NG1C23	Stage 3: lower than the min. angle
NG1C24	Stage 3: exceeded the max. torque

Alarm	Name
NG1C25	Stage 3: lower than the min. torque
NG1D10	Stage 4: operation error
NG1D11	Stage 4: exceeded the tightening torque protection range
NG1D12	Stage 4: exceeded the operation time
NG1D13	Stage 4: insufficient operation time
NG1D20	Stage 4: exceeded tool max. current
NG1D21	Stage 4: lower than tool min. current
NG1D22	Stage 4: exceeded the max. angle
NG1D23	Stage 4: lower than the min. angle
NG1D24	Stage 4: exceeded the max. torque
NG1D25	Stage 4: lower than the min. torque
NG1E10	Stage 5: operation error
NG1E11	Stage 5: exceeded the tightening torque protection range
NG1E12	Stage 5: exceeded the operation time
NG1E13	Stage 5: insufficient operation time
NG1E20	Stage 5: exceeded tool max. current
NG1E21	Stage 5: lower than tool min. current
NG1E22	Stage 5: exceeded the max. angle
NG1E23	Stage 5: lower than the min. angle
NG1E24	Stage 5: exceeded the max. torque
NG1E25	Stage 5: lower than the min. torque
NG1F10	Stage 6: operation error
NG1F11	Stage 6: exceeded the tightening torque protection range
NG1F12	Stage 6: exceeded the operation time
NG1F13	Stage 6: insufficient operation time
NG1F20	Stage 6: exceeded tool max. current
NG1F21	Stage 6: lower than tool min. current
NG1F22	Stage 6: exceeded the max. angle
NG1F23	Stage 6: lower than the min. angle
NG1F24	Stage 6: exceeded the max. torque
NG1F25	Stage 6: lower than the min. torque

13.1.3 Operation warnings

Warning	Name
WN1001	Quantity not reached. String scanning prohibited.
WN1002	Send the tool back for service
WN1003	Parameters not set
WN1004	Unknown tool model
WN1005	Cannot perform tightening and loosening at the same time
WN1051	Exceeded the max. count for NOK tightening
WN1052	The scanner string is null. Tightening prohibited.
WN1053	Screw quantity reached. Tightening prohibited.
WN1054	Exceeded max. operation time
WN1055	Incorrect parameter setting. Tightening prohibited.
WN1056	Tightening prohibited by remote control.
WN1057	Tightening: parameters exceed the tool range
WN1081	Loosening prohibited after tightening OK
WN1082	Loosening prohibited after tightening NOK
WN1083	Exceeded the max. count for NOK loosening
WN1084	Incorrect parameter setting. Loosening prohibited.
WN1085	Loosening prohibited by remote control.
WN1086	Loosening: parameters exceed the tool range

13.2 Causes and corrective actions

13.2.1 Description of device alarms

AL1001 Overcurrent	
Trigger conditions and cause	<p>Condition: main circuit current is greater than 1.5 times the maximum instantaneous current of the controller.</p> <p>Cause:</p> <ol style="list-style-type: none"> 1. The controller output is short-circuited. 2. Electric screwdriver wiring is in error. 3. IGBT is abnormal. 4. Control parameter setting is in error. 5. Control command setting is in error.
Checking method and corrective action	<ol style="list-style-type: none"> 1. Check the connection status between the electric screwdriver and the controller and make sure that the wire is not short-circuited. Prevent the metal conductor from being exposed. 2. If the controller is in error once it is powered on, return your controller to the distributor or the factory for repair. 3. Check whether the control input command changes too greatly. If so, modify the rate of change in the input command.
How to clear the alarm?	Alarm reset.

AL1004 Tool combination error	
Trigger conditions and cause	<p>Condition: an incorrect electric screwdriver is used with the controller.</p> <p>Cause:</p> <ol style="list-style-type: none"> 1. Combination error between controller and electric screwdriver. The electric screwdriver specification cannot be identified. 2. The encoder of the electric screwdriver is loose. 3. The encoder of the electric screwdriver is damaged.
Checking method and corrective action	<ol style="list-style-type: none"> 1. Replace with a matching electric screwdriver. 2. Re-connect the controller and the electric screwdriver, and then cycle power on the controller. If the issue persists, send your electric screwdriver to the distributor or factory for repair.
How to clear the alarm?	Cycle power on the controller.

AL1006 Overload	
Trigger conditions and cause	<p>Condition: electric screwdriver and controller are overloaded.</p> <p>Cause:</p> <ol style="list-style-type: none"> 1. The load is over the rated range and the servo screwdriver system is in a continuous overload condition. 2. Improper setting of controller system parameters.
Checking method and corrective action	<ol style="list-style-type: none"> 1. Monitor whether the average load rate [%] is continuously over 100%. If so, increase the electric screwdriver capacity or reduce the load. 2. A. The speed set for the tightening stage is too low. B. Acceleration / deceleration setting (constant) is too fast. 3. Check whether the controller and the electric screwdriver connector are correctly connected. 4. Return the controller to the distributor or the factory for repair.
How to clear the alarm?	Alarm reset.

AL1007 Excessive deviation of Speed command	
Trigger conditions and cause	Condition: the deviation between speed command and speed feedback exceeds the allowable range. Cause: 1. A drastic change in the input command for speed. 2. Improper setting of the speed deviation warning condition.
Checking method and corrective action	Check if the set acceleration/deceleration constant has caused the drastic change of commands.
How to clear the alarm?	Alarm reset.

AL1011 Encoder error	
Trigger conditions and cause	Condition: the position encoder signal is abnormal. Cause: 1. The encoder wiring is incorrect, the encoder connector is loose, or the encoder wiring is poor. 2. Connection to the encoder is cut off due to interference. 3. The encoder is damaged.
Checking method and corrective action	<ol style="list-style-type: none"> 1. Check if the wiring follows the instructions in the user manual. If not, connect the wiring correctly. 2. Check the connection between the controller and encoder connector. If the connector is loose, reconnect the encoder connector to the controller. 3. Check the connection cable between the controller and screwdriver to see if there are any poor wiring or damaged cable. If so, replace the connector or the cable. 4. Check if the connection for the encoder signal cable is normal. Make sure the encoder signal cable is separated from the power supply or any high-current cables to avoid interference. 5. Use a shielded cable for the encoder. <p>If you took all the above corrective actions but the issue persists, send your electric screwdriver to the distributor or factory for repair.</p>
How to clear the alarm?	Cycle power on the controller.

AL1013 Emergency stop	
Trigger conditions and cause	The emergency stop (DI) is on.
Checking method and corrective action	Check the emergency stop (DI) and make sure that it is off.
How to clear the alarm?	This alarm is automatically cleared when the emergency stop (DI) is set to off.

AL1036 Encoder alarm status error	
Trigger conditions and cause	Condition: encoder status error. Cause: the encoder sends out an alarm signal, but the controller reads back the encoder alarm status as no error.
Checking method and corrective action	<ol style="list-style-type: none"> 1. Confirm whether the ground terminal of the electric screwdriver is correctly grounded. 2. Check if the connection for the encoder signal cable is normal. Make sure the encoder signal cable is separated from the power supply or any high-current cables to avoid interference. 3. Use a shielded cable for the encoder, pull out the shielded mesh, and ground it. 4. Check the speed of the electric screwdriver and make sure that the speed is within the rated range. <p>If you took all the above corrective actions but the issue persists, send your electric screwdriver to the distributor or factory for repair.</p>
How to clear the alarm?	Reset the alarm or cycle power on the controller.

AL1070 Encoder did not complete the read / write procedure

Trigger conditions and cause	When performing encoder barcode writing or related actions, the related commands are incomplete.
Checking method and corrective action	Confirm whether the wiring is correct or whether the connector is loose; then connect the wiring correctly.
How to clear the alarm?	Cycle power on the controller.

AL1087 Tool connection error

Trigger conditions and cause	Condition: the controller does not detect the electric screwdriver connection. Cause: <ol style="list-style-type: none"> 1. The controller is not connected to the electric screwdriver. 2. The electric screwdriver cable is loose at both ends of the interface. 3. The electric screwdriver cable is faulty. 4. The electric screwdriver is faulty.
Checking method and corrective action	<ol style="list-style-type: none"> 1. Check whether the controller is connected to the electric screwdriver. 2. Reconnect the electric screwdriver cable. 3. Replace the cable. 4. Replace the electric screwdriver.
How to clear the alarm?	Cycle power on the controller.

AL1099 Firmware error

Trigger conditions and cause	After the firmware version is upgraded, EEPROM is not reset yet.
Checking method and corrective action	Check whether the firmware upgrade is complete. Remove the Salve-B USB cable for firmware upgrade and cycle power on the controller.
How to clear the alarm?	Cycle power on the controller.

13.2.2 Description of tightening errors

NG1000 Unknown parameter	
Trigger conditions and cause	Condition: when the tightening process starts, the tightening parameter configuration is incorrect. Cause: the controller cannot identify the tightening parameters.
Checking method and corrective action	1. Confirm whether the configured tightening parameters are correct. 2. Confirm whether the tightening parameters configured by the controller are correct.
How to clear the alarm?	Modify the parameters and perform tightening or loosening operation again.

NG1002 Tightening signal ends too early	
Trigger conditions and cause	Condition: during the tightening process, the tightening signal disappears. Cause: 1. During the tightening process, the electric screwdriver is withdrawn early. 2. Transmission of the tightening DI signal is poor.
Checking method and corrective action	1. After tightening is complete, turn off the tightening signal. 2. Use the DO signal to activate the tightening and check if the tightening signal transmission is poor. 3. Perform Push Start to check if the signal wire of Push Start has a poor contact. 4. Perform Lever Start to check if signal wire of Lever Start has a poor contact.
How to clear the alarm?	Unscrew and then re-tighten the screw.

NG1012 Tightening: exceeded max. rotation angle	
Trigger conditions and cause	Condition: during the tightening process, the tightening angle exceeded the maximum rotation angle. Cause: 1. The tightening process fails to meet the tightening conditions, resulting in a tightening failure. 2. The set maximum rotation angle for tightening is not appropriate.
Checking method and corrective action	1. Correct the tightening conditions. 2. Correct the setting of the maximum tightening angle.
How to clear the alarm?	Unscrew and then re-tighten the screw.

NG1013 Tightening: timeout	
Trigger conditions and cause	Condition: the maximum operation time is exceeded before the tightening is complete. Cause: 1. The tightening process fails to meet the tightening conditions, resulting in a tightening failure. 2. The set maximum operation time for tightening is not appropriate.
Checking method and corrective action	1. Correct the tightening conditions. 2. Correct the setting of the maximum tightening time.
How to clear the alarm?	Unscrew and then re-tighten the screw.

NG1014 Tightening: exceeded tool max. current	
Trigger conditions and cause	During the tightening process, the tool current exceeded its maximum current specification.
Checking method and corrective action	1. Check whether the tool current has exceeded the maximum during the tightening process. 2. The controller current feedback is abnormal.
How to clear the alarm?	Cycle power on the controller.

NG1015 Tightening: error occurs during parameter setting

Trigger conditions and cause	Condition: during the process of setting the tightening parameters, an error occurs on other devices. Condition: during the parameter setting, an error occurs on the device.
Checking method and corrective action	Eliminate the causes of device errors.
How to clear the alarm?	After eliminating the errors, re-tighten the screw.

NG1032 Loosening: exceeded max. rotation angle

Trigger conditions and cause	Condition: during the loosening process, the loosening angle exceeded the maximum rotation angle. Cause: the set maximum rotation angle for loosening is not appropriate.
Checking method and corrective action	Correct the setting of the maximum loosening angle.
How to clear the alarm?	Re-loosen the screw.

NG1033 Loosening: timeout

Trigger conditions and cause	Condition: the maximum operation time is exceeded before the loosening is complete. Cause: the set maximum operation time for loosening is not appropriate.
Checking method and corrective action	Correct the setting of the maximum loosening time.
How to clear the alarm?	Re-loosen the screw.

NG1034 Loosening: exceeded tool max. current

Trigger conditions and cause	In the loosening process, the tool current exceeded its maximum current specification.
Checking method and corrective action	1. Check whether the tool current has exceeded the maximum during the loosening process. 2. The control current feedback is abnormal.
How to clear the alarm?	Cycle power on the controller.

NG1035 Loosening: error occurs during parameter setting

Trigger conditions and cause	During the process of setting the loosening parameters, an error occurs on other devices.
Checking method and corrective action	Eliminate the causes of device errors.
How to clear the alarm?	After eliminating the errors, re-loosen the screw.

NG1110 Start stage: operation error

Trigger conditions and cause	Condition: the controller reports an error during the tightening process. Cause: 1. Exceeded the maximum tool torque of this stage. 2. During the tightening process, the tool is in Servo Off state.
Checking method and corrective action	Check whether the tool torque is within the range.
How to clear the alarm?	Unscrew and then re-tighten the screw.

**NG1111 Start stage: exceeded the tool torque protection range;
Start stage: exceeded the tightening torque protection range**

Trigger conditions and cause	Condition: exceeded the torque protection range of the start stage. Cause: 1. Exceeded the torque range of tightening protection (standard strategy). 2. Exceeded the maximum torque specification of the tool (non-standard strategy).
Checking method and corrective action	<ol style="list-style-type: none"> 1. Check whether the tool has reached a foreign object before the tightening process is complete. 2. Check whether the speed set for the start stage is too high. 3. Check whether the settings of the start torque and start angle are appropriate. 4. Check whether the speed of the previous stage is too fast. 5. Check whether the torque, angle or torque rate of the previous stage is set too large. <ul style="list-style-type: none"> ■ The torque in the start stage cannot be greater than the torque in the tightening stage (standard strategy). ■ The torque in the start stage cannot be greater than the tool torque value (non-standard strategy)
How to clear the alarm?	Unscrew and then re-tighten the screw.

NG1112 Start stage: exceeded the operation time

Trigger conditions and cause	Exceeded the maximum operation time of the start stage.
Checking method and corrective action	Check whether the settings of the start stage are appropriate.
How to clear the alarm?	Unscrew and then re-tighten the screw.

NG1113 Start stage: insufficient operation time

Trigger conditions and cause	Shorter than the minimum operation time of the start stage.
Checking method and corrective action	Check whether the settings for the start stage are appropriate.
How to clear the alarm?	Unscrew and then re-tighten the screw.

NG1120 Start stage: exceeded tool max. current

Trigger conditions and cause	After the final tightening torque value is converted into a current value, it exceeds the tool current specifications.
Checking method and corrective action	<ol style="list-style-type: none"> 1. Use the tool current sensor and the torque sensor to compare the current values and check whether the electric screwdriver has aged. 2. Check whether the torque sensor is damaged.
How to clear the alarm?	Unscrew and then re-tighten the screw.

NG1121 Start stage: lower than tool min. current

Trigger conditions and cause	After the final tightening torque value is converted into a current value, it is lower than the tool current specifications.
Checking method and corrective action	<ol style="list-style-type: none"> 1. Use the tool current sensor and the torque sensor to compare the current values and check whether the electric screwdriver has aged. 2. Check whether the torque sensor is damaged.
How to clear the alarm?	Unscrew and then re-tighten the screw.

NG1122 Start stage: exceeded the max. angle	
Trigger conditions and cause	Exceeded the maximum angle of the start stage.
Checking method and corrective action	Check whether the settings of the start stage are appropriate.
How to clear the alarm?	Unscrew and then re-tighten the screw.
NG1123 Start stage: lower than the min. angle	
Trigger conditions and cause	Lower than the minimum angle of the start stage.
Checking method and corrective action	Check whether the settings of the start stage are appropriate.
How to clear the alarm?	Unscrew and then re-tighten the screw.
NG1124 Start stage: exceeded the max. torque	
Trigger conditions and cause	Exceeded the maximum torque of the start stage.
Checking method and corrective action	<ol style="list-style-type: none"> 1. Check whether the settings of the start stage are appropriate. 2. Check whether the speed of the previous stage is too fast. 3. Check whether the torque, angle or torque rate of the previous stage is set too large.
How to clear the alarm?	Unscrew and then re-tighten the screw.
NG1125 Start stage: lower than the min. torque	
Trigger conditions and cause	Lower than the minimum torque of the start stage.
Checking method and corrective action	Check whether the settings of the start stage are appropriate.
How to clear the alarm?	Unscrew and then re-tighten the screw.
NG1210 Rundown stage: operation error	
Trigger conditions and cause	Condition: the controller reports an error during the tightening process. Cause: <ol style="list-style-type: none"> 1. Exceeded the maximum tool torque of the rundown stage. 2. During the tightening process, the tool is in Servo Off state.
Checking method and corrective action	Check whether the tool torque is normal.
How to clear the alarm?	Unscrew and then re-tighten the screw.

NG1211 Rundown stage: exceeded the tool torque protection range; Rundown stage: exceeded the tightening torque protection range	
Trigger conditions and cause	Condition: exceeded the torque protection range of the rundown stage. Cause: 1. Exceeded the torque range of tightening protection (standard strategy). 2. Exceeded the maximum tool torque value (non-standard strategy).
Checking method and corrective action	<ol style="list-style-type: none"> 1. Check whether the tool has reached a foreign object before the tightening process is complete. 2. Check whether the speed of the rundown stage is too fast. 3. Check whether the settings of the rundown torque and rundown angle are appropriate. 4. Check whether the speed of the previous stage is too fast. 5. Check whether the torque, angle or torque rate of the previous stage is set too large. <ul style="list-style-type: none"> ■ The torque in the rundown stage cannot be greater than the torque in the tightening stage (standard strategy). ■ The torque in the rundown stage cannot be greater than the tool torque value (non-standard strategy).
How to clear the alarm?	Unscrew and then re-tighten the screw.

NG1212 Rundown stage: exceeded the operation time	
Trigger conditions and cause	Exceeded the maximum operation time of the rundown stage.
Checking method and corrective action	Check whether the settings for the rundown stage are appropriate.
How to clear the alarm?	Unscrew and then re-tighten the screw.

NG1213 Rundown stage: insufficient operation time	
Trigger conditions and cause	Shorter than the minimum operation time of the rundown stage.
Checking method and corrective action	Check whether the settings for the rundown stage are appropriate.
How to clear the alarm?	Unscrew and then re-tighten the screw.

NG1220 Rundown stage: exceeded tool max. current	
Trigger conditions and cause	After the final tightening torque value is converted into a current value, it exceeds the tool current specifications.
Checking method and corrective action	<ol style="list-style-type: none"> 1. Use the tool current sensor and the torque sensor to compare the current values and check whether the electric screwdriver has aged. 2. Check whether the torque sensor is damaged.
How to clear the alarm?	Unscrew and then re-tighten the screw.

NG1221 Rundown stage: lower than tool min. current	
Trigger conditions and cause	After the final tightening torque value is converted into a current value, it is lower than the tool current specifications.
Checking method and corrective action	<ol style="list-style-type: none"> 1. Use the tool current sensor and the torque sensor to compare the current values and check whether the electric screwdriver has aged. 2. Check whether the torque sensor is damaged.
How to clear the alarm?	Unscrew and then re-tighten the screw.

NG1222 Rundown stage: exceeded the max. angle

Trigger conditions and cause	Exceeded the maximum angle of the rundown stage.
Checking method and corrective action	Check whether the settings for the rundown stage are appropriate.
How to clear the alarm?	Unscrew and then re-tighten the screw.

NG1223 Rundown stage: lower than the min. angle

Trigger conditions and cause	Lower than the minimum angle of the rundown stage.
Checking method and corrective action	Check whether the settings for the rundown stage are appropriate.
How to clear the alarm?	Unscrew and then re-tighten the screw.

NG1224 Rundown stage: exceeded the max. torque

Trigger conditions and cause	Exceeded the maximum torque of the rundown stage.
Checking method and corrective action	<ol style="list-style-type: none"> 1. Check whether the settings for this stage are appropriate. 2. Check whether the speed of the previous stage is too fast. 3. Check whether the torque, angle or torque rate of the previous stage is set too large.
How to clear the alarm?	Unscrew and then re-tighten the screw.

NG1225 Rundown stage: lower than the min. torque

Trigger conditions and cause	Lower than the minimum torque of the rundown stage.
Checking method and corrective action	Check whether the settings for the rundown stage are appropriate.
How to clear the alarm?	Unscrew and then re-tighten the screw.

NG1310 Pre-tightening stage: operation error

Trigger conditions and cause	<p>Condition: the controller reports an error during the tightening process.</p> <p>Cause:</p> <ol style="list-style-type: none"> 1. Exceeded the maximum tool torque of the pre-tightening stage. 2. During the tightening process, the tool is in Servo Off state.
Checking method and corrective action	Check whether the tool torque is normal.
How to clear the alarm?	Unscrew and then re-tighten the screw.

**NG1311 Pre-tightening stage: exceeded the tool torque protection range;
Pre-tightening stage: exceeded the tightening torque protection range**

Trigger conditions and cause	Condition: exceeded the torque protection range of the pre-tightening stage. Cause: 1. Exceeded the torque range of tightening protection (standard strategy). 2. Exceeded the maximum torque specification of the tool (non-standard strategy).
Checking method and corrective action	<ol style="list-style-type: none"> 1. Check whether the tool has reached a foreign object before the tightening process is complete. 2. Check whether the speed of the pre-tightening stage is too fast. 3. Check whether the settings of the start torque and start angle are appropriate. 4. Check whether the speed of the previous stage is too fast. 5. Check whether the torque, angle or torque rate of the previous stage is set too large. <ul style="list-style-type: none"> ■ The torque in the pre-tightening stage cannot be greater than the torque in the tightening stage (standard strategy). ■ The torque in the pre-tightening stage cannot be greater than the tool torque value (non-standard strategy).
How to clear the alarm?	Unscrew and then re-tighten the screw.

NG1312 Pre-tightening stage: exceeded the operation time

Trigger conditions and cause	Exceeded the maximum operation time of the pre-tightening stage.
Checking method and corrective action	Check whether the settings for the pre-tightening stage are appropriate.
How to clear the alarm?	Unscrew and then re-tighten the screw.

NG1313 Pre-tightening stage: insufficient operation time

Trigger conditions and cause	Shorter than the minimum operation time of the pre-tightening stage.
Checking method and corrective action	Check whether the settings for the pre-tightening stage are appropriate.
How to clear the alarm?	Unscrew and then re-tighten the screw.

NG1320 Pre-tightening stage: exceeded tool max. current

Trigger conditions and cause	After the final tightening torque value is converted into a current value, it exceeds the tool current specifications.
Checking method and corrective action	<ol style="list-style-type: none"> 1. Use the tool current sensor and the torque sensor to compare the current values and check whether the electric screwdriver has aged. 2. Check whether the torque sensor is damaged.
How to clear the alarm?	Unscrew and then re-tighten the screw.

NG1321 Pre-tightening stage: lower than tool min. current

Trigger conditions and cause	After the final tightening torque value is converted into a current value, it is lower than the tool current specifications.
Checking method and corrective action	<ol style="list-style-type: none"> 1. Use the tool current sensor and the torque sensor to compare the current values and check whether the electric screwdriver has aged. 2. Check whether the torque sensor is damaged.
How to clear the alarm?	Unscrew and then re-tighten the screw.

NG1322 Pre-tightening stage: exceeded the max. angle	
Trigger conditions and cause	Exceeded the maximum angle of the pre-tightening stage.
Checking method and corrective action	Check whether the settings for the pre-tightening stage are appropriate.
How to clear the alarm?	Unscrew and then re-tighten the screw.
NG1323 Pre-tightening stage: lower than the min. angle	
Trigger conditions and cause	Lower than the minimum angle of the pre-tightening stage.
Checking method and corrective action	Check whether the settings for the pre-tightening stage are appropriate.
How to clear the alarm?	Unscrew and then re-tighten the screw.
NG1324 Pre-tightening stage: exceeded the max. torque	
Trigger conditions and cause	Exceeded the maximum torque of the pre-tightening stage.
Checking method and corrective action	<ol style="list-style-type: none"> 1. Check whether the settings for the pre-tightening stage are appropriate. 2. Check whether the speed of the previous stage is too fast. 3. Check whether the torque, angle or torque rate of the previous stage is set too large.
How to clear the alarm?	Unscrew and then re-tighten the screw.
NG1325 Pre-tightening stage: lower than the min. torque	
Trigger conditions and cause	Lower than the minimum torque of the pre-tightening stage.
Checking method and corrective action	Check whether the settings for the pre-tightening stage are appropriate.
How to clear the alarm?	Unscrew and then re-tighten the screw.
NG1410 Tightening stage: operation error	
Trigger conditions and cause	Condition: the controller reports an error during the tightening process. Cause: <ol style="list-style-type: none"> 1. Exceeded the maximum tool torque of this stage. 2. During the tightening process, the tool is in Servo Off state.
Checking method and corrective action	Check whether the tool torque is normal.
How to clear the alarm?	Unscrew and then re-tighten the screw.

NG1411 Tightening stage: exceeded the tool torque protection range	
Trigger conditions and cause	Condition: exceeded the torque protection range of the tightening stage. Cause: 1. Exceeded the torque range of tool protection (standard strategy). 2. Exceeded the maximum torque specification of the tool (non-standard strategy).
Checking method and corrective action	<ol style="list-style-type: none"> 1. Check whether the settings for the tightening stage are appropriate. 2. Check whether the speed of the tightening stage is too fast. 3. Check whether the target angle and target torque for the tightening stage is set too large. 4. Check whether the speed of the previous stage is too fast. 5. Check whether the torque, angle or torque rate of the previous stage is set too large. <p>■ The torque in the tightening stage cannot be greater than the tool maximum torque.</p>
How to clear the alarm?	Unscrew and then re-tighten the screw.
NG1412 Tightening stage: exceeded the operation time	
Trigger conditions and cause	Exceeded the maximum operation time of the tightening stage.
Checking method and corrective action	Check whether the settings for the tightening stage are appropriate.
How to clear the alarm?	Unscrew and then re-tighten the screw.
NG1413 Tightening stage: insufficient operation time	
Trigger conditions and cause	Shorter than the minimum operation time of the tightening stage.
Checking method and corrective action	Check whether the settings for the tightening stage are appropriate.
How to clear the alarm?	Unscrew and then re-tighten the screw.
NG1420 Tightening stage: exceeded tool max. current	
Trigger conditions and cause	After the final tightening torque value is converted into a current value, it exceeds the tool current specifications.
Checking method and corrective action	<ol style="list-style-type: none"> 1. Use the tool current sensor and the torque sensor to compare the current values and check whether the electric screwdriver has aged. 2. Check whether the torque sensor is damaged.
How to clear the alarm?	Unscrew and then re-tighten the screw.
NG1421 Tightening stage: lower than tool min. current	
Trigger conditions and cause	After the final tightening torque value is converted into a current value, it is lower than the tool current specifications.
Checking method and corrective action	<ol style="list-style-type: none"> 1. Use the tool current sensor and the torque sensor to compare the current values and check whether the electric screwdriver has aged. 2. Check whether the torque sensor is damaged.
How to clear the alarm?	Unscrew and then re-tighten the screw.

NG1422 Tightening stage: exceeded the max. angle

Trigger conditions and cause	Exceeded the maximum angle of the tightening stage.
Checking method and corrective action	Check whether the settings for the tightening stage are appropriate.
How to clear the alarm?	Unscrew and then re-tighten the screw.

NG1423 Tightening stage: lower than the min. angle

Trigger conditions and cause	Lower than the minimum angle of the tightening stage.
Checking method and corrective action	Check whether the settings for the tightening stage are appropriate.
How to clear the alarm?	Unscrew and then re-tighten the screw.

NG1424 Tightening stage: exceeded the max. torque

Trigger conditions and cause	Exceeded the maximum torque of the tightening stage.
Checking method and corrective action	<ol style="list-style-type: none"> 1. Check whether the settings for this stage are appropriate. 2. Check whether the speed of the previous stage is too fast. 3. Check whether the torque, angle or torque rate of the previous stage is set too large.
How to clear the alarm?	Unscrew and then re-tighten the screw.

NG1425 Tightening stage: lower than the min. torque

Trigger conditions and cause	Lower than the minimum torque of the tightening stage.
Checking method and corrective action	Check whether the settings for this stage are appropriate.
How to clear the alarm?	Unscrew and then re-tighten the screw.

NG1510 Rundown stage (torque rate): operation error

Trigger conditions and cause	Condition: the controller reports an error during the tightening process. Cause: <ol style="list-style-type: none"> 1. Exceeded the maximum tool torque of this stage. 2. During the tightening process, the tool is in Servo Off state.
Checking method and corrective action	Check whether the tool torque is normal.
How to clear the alarm?	Unscrew and then re-tighten the screw.

NG1511 Rundown stage (torque rate): exceeded the tightening torque protection range	
Trigger conditions and cause	Condition: exceeded the torque protection range of the rundown stage. Cause: 1. Exceeded the torque range of tightening protection (standard strategy). 2. Exceeded the maximum torque specification of the tool (non-standard strategy).
Checking method and corrective action	<ol style="list-style-type: none"> 1. Check whether the tool has reached a foreign object before the tightening process is complete. 2. Check whether the speed of the rundown stage is too fast. 3. Check whether the settings of the torque rate and angle interval for torque rate calculation are appropriate. 4. Check whether the speed of the previous stage is too fast. 5. Check whether the torque, angle or torque rate of the previous stage is set too large. <ul style="list-style-type: none"> ■ The torque in the rundown stage cannot be greater than the torque in the tightening stage (standard strategy). ■ The torque in the rundown stage cannot be greater than the tool torque value (non-standard strategy).
How to clear the alarm?	Unscrew and then re-tighten the screw.

NG1512 Rundown stage (torque rate): exceeded the operation time	
Trigger conditions and cause	Exceeded the maximum operation time of the rundown stage.
Checking method and corrective action	Check whether the settings for the rundown stage are appropriate.
How to clear the alarm?	Unscrew and then re-tighten the screw.

NG1513 Rundown stage (torque rate): insufficient operation time	
Trigger conditions and cause	Shorter than the minimum operation time of the rundown stage.
Checking method and corrective action	Check whether the settings for the rundown stage are appropriate.
How to clear the alarm?	Unscrew and then re-tighten the screw.

NG1520 Rundown stage (torque rate): exceeded tool max. current	
Trigger conditions and cause	After the final tightening torque value is converted into a current value, it exceeds the tool current specifications.
Checking method and corrective action	<ol style="list-style-type: none"> 1. Use the tool current sensor and the torque sensor to compare the current values and check whether the electric screwdriver has aged. 2. Check whether the torque sensor is damaged.
How to clear the alarm?	Unscrew and then re-tighten the screw.

NG1521 Rundown stage (torque rate): lower than tool min. current

Trigger conditions and cause	After the final tightening torque value is converted into a current value, it is lower than the tool current specifications.
Checking method and corrective action	<ol style="list-style-type: none"> 1. Use the tool current sensor and the torque sensor to compare the current values and check whether the electric screwdriver has aged. 2. Check whether the torque sensor is damaged.
How to clear the alarm?	Unscrew and then re-tighten the screw.

NG1522 Rundown stage (torque rate): exceeded the max. angle

Trigger conditions and cause	Exceeded the maximum angle of the rundown stage.
Checking method and corrective action	Check whether the settings for the rundown stage are appropriate.
How to clear the alarm?	Unscrew and then re-tighten the screw.

NG1523 Rundown stage (torque rate): lower than the min. angle

Trigger conditions and cause	Lower than the minimum angle of the rundown stage.
Checking method and corrective action	Check whether the settings for the rundown stage are appropriate.
How to clear the alarm?	Unscrew and then re-tighten the screw.

NG1524 Rundown stage (torque rate): exceeded the max. torque

Trigger conditions and cause	Exceeded the maximum torque of the rundown stage.
Checking method and corrective action	<ol style="list-style-type: none"> 1. Check whether the settings for the rundown stage are appropriate. 2. Check whether the speed of the previous stage is too fast. 3. Check whether the torque, angle or torque rate of the previous stage is set too large.
How to clear the alarm?	Unscrew and then re-tighten the screw.

NG1525 Rundown stage (torque rate): lower than the min. torque

Trigger conditions and cause	Lower than the minimum torque of the rundown stage.
Checking method and corrective action	Check whether the settings for the rundown stage are appropriate.
How to clear the alarm?	Unscrew and then re-tighten the screw.

NG1881 Loosening stage: lower than the set torque	
Trigger conditions and cause	The torque used for the loosening operation is lower than the set torque.
Checking method and corrective action	<ol style="list-style-type: none"> 1. Check whether the settings for this stage are appropriate. 2. Check whether the tightened screw has been loosened.
How to clear the alarm?	Unscrew the screw again.

NG1891 Loosening stage: exceeded the tool torque protection range	
Trigger conditions and cause	The torque used for the loosening operation is higher than the tool torque protection range.
Checking method and corrective action	Check if the loosening torque exceeds the tool specifications.
How to clear the alarm?	Unscrew the screw again.

NG1A10 Stage 1: operation error	
Trigger conditions and cause	Condition: the controller reports an error during the tightening process. Cause: <ol style="list-style-type: none"> 1. Exceeded the maximum tool torque of this stage. 2. During the tightening process, the tool is in Servo Off state.
Checking method and corrective action	Check whether the tool torque is normal.
How to clear the alarm?	Unscrew and then re-tighten the screw.

NG1A11 Stage 1: exceeded the tightening torque protection range	
Trigger conditions and cause	Condition: exceeded the torque protection range of Stage 1.
Checking method and corrective action	<ol style="list-style-type: none"> 1. Check whether the tool has reached a foreign object before the tightening process is complete. 2. Check whether the speed of Stage 1 is too fast. 3. Check whether the settings of the torque rate and angle interval for torque rate calculation are appropriate. <p>■ The torque in Stage 1 cannot be greater than the tool maximum torque.</p>
How to clear the alarm?	Unscrew and then re-tighten the screw.

NG1A12 Stage 1: exceeded the operation time	
Trigger conditions and cause	Exceeded the maximum operation time of Stage 1.
Checking method and corrective action	Check whether the settings for Stage 1 are appropriate.
How to clear the alarm?	Unscrew and then re-tighten the screw.

NG1A13 Stage 1: insufficient operation time

Trigger conditions and cause	Shorter than the minimum operation time of Stage 1.
Checking method and corrective action	Check whether the settings for Stage 1 are appropriate.
How to clear the alarm?	Unscrew and then re-tighten the screw.

NG1A20 Stage 1: exceeded tool max. current

Trigger conditions and cause	After the final tightening torque value is converted into a current value, it exceeds the tool current specifications.
Checking method and corrective action	1. Use the tool current sensor and the torque sensor to compare the current values and check whether the electric screwdriver has aged. 2. Check whether the torque sensor is damaged.
How to clear the alarm?	Unscrew and then re-tighten the screw.

NG1A21 Stage 1: lower than tool min. current

Trigger conditions and cause	After the final tightening torque value is converted into a current value, it is lower than the tool current specifications.
Checking method and corrective action	1. Use the tool current sensor and the torque sensor to compare the current values and check whether the electric screwdriver has aged. 2. Check whether the torque sensor is damaged.
How to clear the alarm?	Unscrew and then re-tighten the screw.

NG1A22 Stage 1: exceeded the max. angle

Trigger conditions and cause	Exceeded the maximum angle of Stage 1.
Checking method and corrective action	Check whether the settings for Stage 1 are appropriate.
How to clear the alarm?	Unscrew and then re-tighten the screw.

NG1A23 Stage 1: lower than the min. angle

Trigger conditions and cause	Lower than the minimum angle of Stage 1.
Checking method and corrective action	Check whether the settings for Stage 1 are appropriate.
How to clear the alarm?	Unscrew and then re-tighten the screw.

NG1A24 Stage 1: exceeded the max. torque

Trigger conditions and cause	Exceeded the maximum torque of Stage 1.
Checking method and corrective action	<ol style="list-style-type: none"> 1. Check whether the settings for Stage 1 are appropriate. 2. Check whether the speed of the previous stage is too fast. 3. Check whether the torque, angle or torque rate of the previous stage is set too large.
How to clear the alarm?	Unscrew and then re-tighten the screw.

NG1A25 Stage 1: lower than the min. torque

Trigger conditions and cause	Lower than the minimum torque of Stage 1.
Checking method and corrective action	Check whether the settings for Stage 1 are appropriate.
How to clear the alarm?	Unscrew and then re-tighten the screw.

NG1B10 Stage 2: operation error

Trigger conditions and cause	<p>Condition: the controller reports an error during the tightening process.</p> <p>Cause:</p> <ol style="list-style-type: none"> 1. Exceeded the maximum tool torque of this stage. 2. During the tightening process, the tool is in Servo Off state.
Checking method and corrective action	Check whether the tool torque is normal.
How to clear the alarm?	Unscrew and then re-tighten the screw.

NG1B11 Stage 2: exceeded the tightening torque protection range

Trigger conditions and cause	Exceeded the torque protection range of Stage 2.
Checking method and corrective action	<ol style="list-style-type: none"> 1. Check whether the tool has reached a foreign object before the tightening process is complete. 2. Check whether the speed of Stage 2 is too fast. 3. Check whether the settings of the torque rate and angle interval for torque rate calculation are appropriate. 4. Check whether the speed of the previous stage is too fast. 5. Check whether the torque, angle or torque rate of the previous stage is set too large. <p>■ The torque in Stage 2 cannot be greater than the tool maximum torque.</p>
How to clear the alarm?	Unscrew and then re-tighten the screw.

NG1B12 Stage 2: exceeded the operation time

Trigger conditions and cause	Exceeded the maximum operation time of Stage 2.
Checking method and corrective action	Check whether the settings for Stage 2 are appropriate.
How to clear the alarm?	Unscrew and then re-tighten the screw.

NG1B13 Stage 2: insufficient operation time

Trigger conditions and cause	Shorter than the minimum operation time of Stage 2.
Checking method and corrective action	Check whether the settings for Stage 2 are appropriate.
How to clear the alarm?	Unscrew and then re-tighten the screw.

NG1B20 Stage 2: exceeded tool max. current

Trigger conditions and cause	After the final tightening torque value is converted into a current value, it exceeds the tool current specifications.
Checking method and corrective action	1. Use the tool current sensor and the torque sensor to compare the current values and check whether the electric screwdriver has aged. 2. Check whether the torque sensor is damaged.
How to clear the alarm?	Unscrew and then re-tighten the screw.

NG1B21 Stage 2: lower than tool min. current

Trigger conditions and cause	After the final tightening torque value is converted into a current value, it is lower than the tool current specifications.
Checking method and corrective action	1. Use the tool current sensor and the torque sensor to compare the current values and check whether the electric screwdriver has aged. 2. Check whether the torque sensor is damaged.
How to clear the alarm?	Unscrew and then re-tighten the screw.

NG1B22 Stage 2: exceeded the max. angle

Trigger conditions and cause	Exceeded the maximum angle of Stage 2.
Checking method and corrective action	Check whether the settings for Stage 2 are appropriate.
How to clear the alarm?	Unscrew and then re-tighten the screw.

NG1B23 Stage 2: lower than the min. angle

Trigger conditions and cause	Lower than the minimum angle of Stage 2.
Checking method and corrective action	Check whether the settings for Stage 2 are appropriate.
How to clear the alarm?	Unscrew and then re-tighten the screw.

NG1B24 Stage 2: exceeded the max. torque	
Trigger conditions and cause	Exceeded the maximum torque of Stage 2.
Checking method and corrective action	<ol style="list-style-type: none"> 1. Check whether the settings for Stage 2 are appropriate. 2. Check whether the speed of the previous stage is too fast. 3. Check whether the torque, angle or torque rate of the previous stage is set too large.
How to clear the alarm?	Unscrew and then re-tighten the screw.

NG1B25 Stage 2: lower than the min. torque	
Trigger conditions and cause	Lower than the minimum torque of Stage 2.
Checking method and corrective action	Check whether the settings for Stage 2 are appropriate.
How to clear the alarm?	Unscrew and then re-tighten the screw.

NG1C10 Stage 3: operation error	
Trigger conditions and cause	Condition: the controller reports an error during the tightening process. Cause: <ol style="list-style-type: none"> 1. Exceeded the maximum tool torque of this stage. 2. During the tightening process, the tool is in Servo Off state.
Checking method and corrective action	Check whether the tool torque is normal.
How to clear the alarm?	Unscrew and then re-tighten the screw.

NG1C11 Stage 3: exceeded the tightening torque protection range	
Trigger conditions and cause	Exceeded the torque protection range of Stage 3.
Checking method and corrective action	<ol style="list-style-type: none"> 1. Check whether the tool has reached a foreign object before the tightening process is complete. 2. Check whether the speed of Stage 3 is too fast. 3. Check whether the settings of the torque rate and angle interval for torque rate calculation are appropriate. 4. Check whether the speed of the previous stage is too fast. 5. Check whether the torque, angle or torque rate of the previous stage is set too large. <p>■ The torque in Stage 3 cannot be greater than the tool maximum torque.</p>
How to clear the alarm?	Unscrew and then re-tighten the screw.

NG1C12 Stage 3: exceeded the operation time

Trigger conditions and cause	Exceeded the maximum operation time of Stage 3.
Checking method and corrective action	Check whether the settings for Stage 3 are appropriate.
How to clear the alarm?	Unscrew and then re-tighten the screw.

NG1C13 Stage 3: insufficient operation time

Trigger conditions and cause	Shorter than the minimum operation time of Stage 3.
Checking method and corrective action	Check whether the settings for Stage 3 are appropriate.
How to clear the alarm?	Unscrew and then re-tighten the screw.

NG1C20 Stage 3: exceeded tool max. current

Trigger conditions and cause	After the final tightening torque value is converted into a current value, it exceeds the tool current specifications.
Checking method and corrective action	1. Use the tool current sensor and the torque sensor to compare the current values and check whether the electric screwdriver has aged. 2. Check whether the torque sensor is damaged.
How to clear the alarm?	Unscrew and then re-tighten the screw.

NG1C21 Stage 3: lower than tool min. current

Trigger conditions and cause	After the final tightening torque value is converted into a current value, it is lower than the tool current specifications.
Checking method and corrective action	1. Use the tool current sensor and the torque sensor to compare the current values and check whether the electric screwdriver has aged. 2. Check whether the torque sensor is damaged.
How to clear the alarm?	Unscrew and then re-tighten the screw.

NG1C22 Stage 3: exceeded the max. angle

Trigger conditions and cause	Exceeded the maximum angle of Stage 3.
Checking method and corrective action	Check whether the settings for Stage 3 are appropriate.
How to clear the alarm?	Unscrew and then re-tighten the screw.

NG1C23 Stage 3: lower than the min. angle

Trigger conditions and cause	Lower than the minimum angle of Stage 3.
Checking method and corrective action	Check whether the settings for Stage 3 are appropriate.
How to clear the alarm?	Unscrew and then re-tighten the screw.

NG1C24 Stage 3: exceeded the max. torque	
Trigger conditions and cause	Exceeded the maximum torque of Stage 3.
Checking method and corrective action	<ol style="list-style-type: none"> 1. Check whether the settings for Stage 3 are appropriate. 2. Check whether the speed of the previous stage is too fast. 3. Check whether the torque, angle or torque rate of the previous stage is set too large.
How to clear the alarm?	Unscrew and then re-tighten the screw.

NG1C25 Stage 3: lower than the min. torque	
Trigger conditions and cause	Lower than the minimum torque of Stage 3.
Checking method and corrective action	Check whether the settings for Stage 3 are appropriate.
How to clear the alarm?	Unscrew and then re-tighten the screw.

NG1D10 Stage 4: operation error	
Trigger conditions and cause	Condition: the controller reports an error during the tightening process. Cause: <ol style="list-style-type: none"> 1. Exceeded the maximum tool torque of Stage 4. 2. During the tightening process, the tool is in Servo Off state.
Checking method and corrective action	Check whether the tool torque is normal.
How to clear the alarm?	Unscrew and then re-tighten the screw.

NG1D11 Stage 4: exceeded the tightening torque protection range	
Trigger conditions and cause	Exceeded the torque protection range of Stage 4.
Checking method and corrective action	<ol style="list-style-type: none"> 1. Check whether the tool has reached a foreign object before the tightening process is complete. 2. Check whether the speed of Stage 4 is too fast. 3. Check whether the settings of the torque rate and angle interval for torque rate calculation are appropriate. 4. Check whether the speed of the previous stage is too fast. 5. Check whether the torque, angle or torque rate of the previous stage is set too large. <p>■ The torque in Stage 4 cannot be greater than the tool maximum torque.</p>
How to clear the alarm?	Unscrew and then re-tighten the screw.

NG1D12 Stage 4: exceeded the operation time	
Trigger conditions and cause	Exceeded the maximum operation time of Stage 4.
Checking method and corrective action	Check whether the settings for Stage 4 are appropriate.
How to clear the alarm?	Unscrew and then re-tighten the screw.
NG1D13 Stage 4: insufficient operation time	
Trigger conditions and cause	Shorter than the minimum operation time of Stage 4.
Checking method and corrective action	Check whether the settings for Stage 4 are appropriate.
How to clear the alarm?	Unscrew and then re-tighten the screw.
NG1D20 Stage 4: exceeded tool max. current	
Trigger conditions and cause	After the final tightening torque value is converted into a current value, it exceeds the tool current specifications.
Checking method and corrective action	1. Use the tool current sensor and the torque sensor to compare the current values and check whether the electric screwdriver has aged. 2. Check whether the torque sensor is damaged.
How to clear the alarm?	Unscrew and then re-tighten the screw.
NG1D21 Stage 4: lower than tool min. current	
Trigger conditions and cause	After the final tightening torque value is converted into a current value, it is lower than the tool current specifications.
Checking method and corrective action	1. Use the tool current sensor and the torque sensor to compare the current values and check whether the electric screwdriver has aged. 2. Check whether the torque sensor is damaged.
How to clear the alarm?	Unscrew and then re-tighten the screw.
NG1D22 Stage 4: exceeded the max. angle	
Trigger conditions and cause	Exceeded the maximum angle of Stage 4.
Checking method and corrective action	Check whether the settings for Stage 4 are appropriate.
How to clear the alarm?	Unscrew and then re-tighten the screw.
NG1D23 Stage 4: lower than the min. angle	
Trigger conditions and cause	Lower than the minimum angle of Stage 4.
Checking method and corrective action	Check whether the settings for Stage 4 are appropriate.
How to clear the alarm?	Unscrew and then re-tighten the screw.

NG1D24 Stage 4: exceeded the max. torque	
Trigger conditions and cause	Exceeded the maximum torque of Stage 4.
Checking method and corrective action	<ol style="list-style-type: none"> 1. Check whether the settings for this stage are appropriate. 2. Check whether the speed of the previous stage is too fast. 3. Check whether the torque, angle or torque rate of the previous stage is set too large.
How to clear the alarm?	Unscrew and then re-tighten the screw.

NG1D25 Stage 4: lower than the min. torque	
Trigger conditions and cause	Lower than the minimum torque of Stage 4.
Checking method and corrective action	Check whether the settings for this stage are appropriate.
How to clear the alarm?	Unscrew and then re-tighten the screw.

NG1E10 Stage 5: operation error	
Trigger conditions and cause	Condition: the controller reports an error during the tightening process. Cause: <ol style="list-style-type: none"> 1. Exceeded the maximum tool torque of this stage. 2. During the tightening process, the tool is in Servo Off state.
Checking method and corrective action	Check whether the tool torque is normal.
How to clear the alarm?	Unscrew and then re-tighten the screw.

NG1E11 Stage 5: exceeded the tightening torque protection range	
Trigger conditions and cause	Exceeded the torque protection range of Stage 5.
Checking method and corrective action	<ol style="list-style-type: none"> 1. Check whether the tool has reached a foreign object before the tightening process is complete. 2. Check whether the speed of Stage 5 is too fast. 3. Check whether the settings of the torque rate and angle interval for torque rate calculation are appropriate. 4. Check whether the speed of the previous stage is too fast. 5. Check whether the torque, angle or torque rate of the previous stage is set too large. <p>■ The torque in Stage 5 cannot be greater than the tool maximum torque.</p>
How to clear the alarm?	Unscrew and then re-tighten the screw.

NG1E12 Stage 5: exceeded the operation time

Trigger conditions and cause	Exceeded the maximum operation time of Stage 5.
Checking method and corrective action	Check whether the settings for Stage 5 are appropriate.
How to clear the alarm?	Unscrew and then re-tighten the screw.

NG1E13 Stage 5: insufficient operation time

Trigger conditions and cause	Shorter than the minimum operation time of Stage 5.
Checking method and corrective action	Check whether the settings for Stage 5 are appropriate.
How to clear the alarm?	Unscrew and then re-tighten the screw.

NG1E20 Stage 5: exceeded tool max. current

Trigger conditions and cause	After the final tightening torque value is converted into a current value, it exceeds the tool current specifications.
Checking method and corrective action	1. Use the tool current sensor and the torque sensor to compare the current values and check whether the electric screwdriver has aged. 2. Check whether the torque sensor is damaged.
How to clear the alarm?	Unscrew and then re-tighten the screw.

NG1E21 Stage 5: lower than tool min. current

Trigger conditions and cause	After the final tightening torque value is converted into a current value, it is lower than the tool current specifications.
Checking method and corrective action	1. Use the tool current sensor and the torque sensor to compare the current values and check whether the electric screwdriver has aged. 2. Check whether the torque sensor is damaged.
How to clear the alarm?	Unscrew and then re-tighten the screw.

NG1E22 Stage 5: exceeded the max. angle

Trigger conditions and cause	Exceeded the maximum angle of Stage 5.
Checking method and corrective action	Check whether the settings for Stage 5 are appropriate.
How to clear the alarm?	Unscrew and then re-tighten the screw.

NG1E23 Stage 5: lower than the min. angle

Trigger conditions and cause	Lower than the minimum angle of Stage 5.
Checking method and corrective action	Check whether the settings for Stage 5 are appropriate.
How to clear the alarm?	Unscrew and then re-tighten the screw.

NG1E24 Stage 5: exceeded the max. torque	
Trigger conditions and cause	Exceeded the maximum torque of Stage 5.
Checking method and corrective action	<ol style="list-style-type: none"> 1. Check whether the settings for Stage 5 are appropriate. 2. Check whether the speed of the previous stage is too fast. 3. Check whether the torque, angle or torque rate of the previous stage is set too large.
How to clear the alarm?	Unscrew and then re-tighten the screw.

NG1E25 Stage 5: lower than the min. torque	
Trigger conditions and cause	Lower than the minimum torque of Stage 5.
Checking method and corrective action	Check whether the settings for Stage 5 are appropriate.
How to clear the alarm?	Unscrew and then re-tighten the screw.

NG1F10 Stage 6: operation error	
Trigger conditions and cause	<p>Condition: the controller reports an error during the tightening process.</p> <p>Cause:</p> <ol style="list-style-type: none"> 1. Exceeded the maximum tool torque of this stage. 2. During the tightening process, the tool is in Servo Off state.
Checking method and corrective action	Check whether the tool torque is normal.
How to clear the alarm?	Unscrew and then re-tighten the screw.

NG1F11 Stage 6: exceeded the tightening torque protection range	
Trigger conditions and cause	Exceeded the torque protection range of Stage 6.
Checking method and corrective action	<ol style="list-style-type: none"> 1. Check whether the tool has reached a foreign object before the tightening process is complete. 2. Check whether the speed of Stage 6 is too fast. 3. Check whether the settings of the torque rate and angle interval for torque rate calculation are appropriate. 4. Check whether the speed of the previous stage is too fast. 5. Check whether the torque, angle or torque rate of the previous stage is set too large. <p>■ The torque in stage 6 cannot be greater than the tool maximum torque</p>
How to clear the alarm?	Unscrew and then re-tighten the screw.

NG1F12 Stage 6: exceeded the operation time	
Trigger conditions and cause	Exceeded the maximum operation time of Stage 6.
Checking method and corrective action	Check whether the settings for Stage 6 are appropriate.
How to clear the alarm?	Unscrew and then re-tighten the screw.
NG1F13 Stage 6: insufficient operation time	
Trigger conditions and cause	Shorter than the minimum operation time of Stage 6.
Checking method and corrective action	Check whether the settings for Stage 6 are appropriate.
How to clear the alarm?	Unscrew and then re-tighten the screw.
NG1F20 Stage 6: exceeded tool max. current	
Trigger conditions and cause	After the final tightening torque value is converted into a current value, it exceeds the tool current specifications.
Checking method and corrective action	1. Use the tool current sensor and the torque sensor to compare the current values and check whether the electric screwdriver has aged. 2. Check whether the torque sensor is damaged.
How to clear the alarm?	Unscrew and then re-tighten the screw.
NG1F21 Stage 6: lower than tool min. current	
Trigger conditions and cause	After the final tightening torque value is converted into a current value, it is lower than the tool current specifications.
Checking method and corrective action	1. Use the tool current sensor and the torque sensor to compare the current values and check whether the electric screwdriver has aged. 2. Check whether the torque sensor is damaged.
How to clear the alarm?	Unscrew and then re-tighten the screw.
NG1F22 Stage 6: exceeded the max. angle	
Trigger conditions and cause	Exceeded the maximum angle of Stage 6.
Checking method and corrective action	Check whether the settings for Stage 6 are appropriate.
How to clear the alarm?	Unscrew and then re-tighten the screw.
NG1F23 Stage 6: lower than the min. angle	
Trigger conditions and cause	Lower than the minimum angle of Stage 6.
Checking method and corrective action	Check whether the settings for Stage 6 are appropriate.
How to clear the alarm?	Unscrew and then re-tighten the screw.

NG1F24 Stage 6: exceeded the max. torque	
Trigger conditions and cause	Exceeded the maximum torque of Stage 6.
Checking method and corrective action	<ol style="list-style-type: none"> 1. Check whether the settings for Stage 6 are appropriate. 2. Check whether the speed of the previous stage is too fast. 3. Check whether the torque, angle or torque rate of the previous stage is set too large.
How to clear the alarm?	Unscrew and then re-tighten the screw.

NG1F25 Stage 6: lower than the min. torque	
Trigger conditions and cause	Lower than the minimum torque of Stage 6.
Checking method and corrective action	Check whether the settings for Stage 6 are appropriate.
How to clear the alarm?	Unscrew and then re-tighten the screw.

13.2.3 Description of operation warnings

WN1001 Quantity not reached. String scanning prohibited.	
Trigger conditions and cause	The set quantity of the screws to be tightened is not reached, so string scanning is prohibited.
Checking method and corrective action	<ol style="list-style-type: none"> 1. Execute the string input only after the screw quantity is reached. 2. Execute the string input only after the screw quantity is reset.
How to clear the alarm?	Complete the operation for the set screw quantity, and then set the string.
WN1002 Send the tool back for service	
Trigger conditions and cause	Condition: the total tightening and loosening count exceeds the count suggested for maintenance service. Cause: the reminder to return the electric screwdriver to factory for repair and maintenance is triggered.
Checking method and corrective action	Return the electric screwdriver to the factory for repair and maintenance.
How to clear the alarm?	Return the electric screwdriver to the factory.
WN1003 Parameters not set	
Trigger conditions and cause	Condition: the parameter configuration is incomplete. Cause: <ol style="list-style-type: none"> 1. The tightening source is not configured. 2. The parameter configuration is not complete when the electric screwdriver starts to run.
Checking method and corrective action	<ol style="list-style-type: none"> 1. Check whether the parameters of the tightening source are configured. 2. Confirm that the ready signal is on, and then start tightening.
How to clear the alarm?	Restart the tightening operation.
WN1004 Unknown tool model	
Trigger conditions and cause	The controller cannot identify the specifications and model of the electric screwdriver.
Checking method and corrective action	<ol style="list-style-type: none"> 1. Confirm whether the electric screwdriver is connected correctly. 2. Confirm whether the controller supports the specifications of this electric screwdriver.
How to clear the alarm?	Return the electric screwdriver to the factory.
WN1005 Cannot perform tightening and loosening at the same time	
Trigger conditions and cause	The controller receives both tightening start and loosening start signals at the same time.
Checking method and corrective action	<ol style="list-style-type: none"> 1. Check the executed actions. 2. Check whether the timings for sending the signals conflict.
How to clear the alarm?	Check the executed actions and then restart the electric screwdriver.

WN1051 Exceeded the max. count for NOK tightening	
Trigger conditions and cause	Exceeded the allowable number of failures (NOK count) when tightening.
Checking method and corrective action	1. Identify the main cause of failure. If the cause of failure is an infrequent occurrence, go to the Sources page to modify the conditions for the allowable number of failures (NOK count). 2. Reset the screw progress.
How to clear the alarm?	Modify the limiting conditions and re-tighten the screw.
WN1052 The scanner string is null. Tightening prohibited.	
Trigger conditions and cause	The scanner string is null, so tightening is prohibited.
Checking method and corrective action	1. Input the scanner string. 2. Correct the conditions set in the Sources page.
How to clear the alarm?	Modify the limiting conditions and re-tighten the screw.
WN1053 Screw quantity reached. Tightening prohibited.	
Trigger conditions and cause	The set screw quantity to be tightened is reached, so tightening is prohibited.
Checking method and corrective action	1. Pair the new tightening parameters or tightening sequence. 2. Reset the screw progress.
How to clear the alarm?	Modify the limiting conditions and re-tighten the screw.
WN1054 Exceeded max. operation time	
Trigger conditions and cause	The tightening process exceeds the maximum operation time.
Checking method and corrective action	1. Correct the conditions set in the Sources page. 2. Reset the screw progress.
How to clear the alarm?	Modify the limiting conditions and re-tighten the screw.
WN1055 Incorrect parameter setting. Tightening prohibited.	
Trigger conditions and cause	Condition: the parameter setting is incorrect, so tightening is prohibited. Cause: 1. The tightening source is not configured. 2. The tightening parameter or tightening sequence is deleted.
Checking method and corrective action	Go to the Sources page and correct the parameter.
How to clear the alarm?	Select other tightening parameters or modify the tightening sequence, then re-tighten the screw.

WN1056 Tightening prohibited by remote control	
Trigger conditions and cause	Tightening operation is prohibited by remote control.
Checking method and corrective action	Check Modbus communication #406 for the restrict tightening operation status.
How to clear the alarm?	Modify the restricting conditions in remote control and re-tighten the screw.
WN1057 Tightening: parameters exceed the tool range	
Trigger conditions and cause	Condition: the parameter settings exceed the tool range, so tightening is prohibited. Cause: 1. The parameter setting exceeds the limit value of the tool. 2. The parameters configured with communication control are not set properly. 3. The parameter setting imported by the USB drive is not appropriate.
Checking method and corrective action	Modify the content of the currently running tightening parameters.
How to clear the alarm?	Modify the parameters and re-tighten the screw.
WN1081 Loosening prohibited after tightening OK	
Trigger conditions and cause	When the tightening result displays OK, the loosening is prohibited.
Checking method and corrective action	Correct the conditions set in the Sources page.
How to clear the alarm?	Modify the limiting conditions and re-loosen the screw.
WN1082 Loosening prohibited after tightening NOK	
Trigger conditions and cause	When the tightening result displays NOK, the loosening is prohibited.
Checking method and corrective action	Correct the conditions set in the Sources page.
How to clear the alarm?	Modify the limiting conditions and re-loosen the screw.
WN1083 Exceeded the max. count for NOK loosening	
Trigger conditions and cause	Exceeded the allowable number of failures (NOK count) when loosening.
Checking method and corrective action	1. Modify the conditions set in the Sources page. 2. Reset the screw progress.
How to clear the alarm?	Modify the limiting conditions and re-loosen the screw.

WN1084 Incorrect parameter setting. Loosening prohibited.	
Trigger conditions and cause	Condition: the parameter setting is incorrect, so loosening is prohibited. Cause: 1. The tightening source is not configured. 2. The tightening parameter or tightening sequence is deleted.
Checking method and corrective action	Correct the settings in the Sources page.
How to clear the alarm?	Modify the limiting conditions and re-loosen the screw.
WN1085 Loosening prohibited by remote control	
Trigger conditions and cause	Loosening operation is prohibited by remote control.
Checking method and corrective action	Check Modbus communication #407 for the restrict loosening operation status.
How to clear the alarm?	Modify the restricting conditions in remote control and re-loosen the screw.
WN1086 Loosening: parameters exceed the tool range	
Trigger conditions and cause	Condition: the parameter setting exceeds the tool range, so loosening is prohibited. Cause: 1. The parameter setting exceeds the limit value of the tool. 2. The parameters configured with communication control are not set properly. 3. The parameter setting imported by the USB drive is not appropriate.
Checking method and corrective action	Modify the content of the currently running loosening parameters.
How to clear the alarm?	Modify the parameters and re-loosen the screw.

Modbus Communication - Function Codes

A

This chapter provides details of the handshake method and information of the Modbus communication interface provided by the ASA smart servo screw screwdriver system.

A.1 System structure	A-3
A.2 Operational status of the smart servo screwdriver system	A-8
A.3 Handshake data of the smart servo screwdriver system.....	A-12
A.3.1 Parameters operations	A-14
#100 Write the parameters	A-14
#150 Read the parameters	A-18
A.3.2 Sequence operations	A-21
#200 Write the sequence.....	A-21
#250 Read the sequence	A-34
A.3.3 Sources operations	A-48
#300 Write the operation mode and switching method of Sources	A-48
#301 Write the contents of single source settings	A-49
#350 Read the operation mode and switching method of Sources	A-52
#351 Read the contents of single source settings	A-53
A.3.4 Results operations.....	A-56
#400 Write the switching method of Sources	A-56
#401 Write the scanner string.....	A-57
#402 Write to clear all errors	A-59
#403 Write to reset the operation progress	A-60
#404 Write to execute the previous step	A-61
#405 Write to execute the next step.....	A-62
#406 Write to restrict tightening operation	A-63
#407 Write to restrict loosening operation	A-64
#408 Write the scanner advanced settings	A-65
#450 Read the switching method of Sources	A-66
#451 Read the scanner string.....	A-68
#452 Read the scanner advanced settings	A-69
A.3.5 Controller operations.....	A-71
#500 Write the request for permissions login	A-72
#501 Write the request for password change	A-73

A

#502 Write the request for permissions logout.....	A-75
#503 Write the page permissions	A-76
#504 Write the Ethernet settings	A-77
#505 Request for factory reset.....	A-79
#506 Write the buzzer sound pattern.....	A-80
#507 Write the DI/DO functions.....	A-81
#508 Write the DI/DO conversion table.....	A-83
#509 Write the default torque unit.....	A-91
#510 Write the default tool start condition.....	A-92
#550 Read the Ethernet settings	A-93
#551 Read the page permissions	A-94
#552 Read the firmware version	A-95
#553 Read the DI/DO functions	A-96
#554 Read the DI/DO conversion table	A-99
#555 Read the default torque unit	A-106
#556 Read the default tool start condition	A-107
A.3.6 Tool operations	A-109
#600 Write to activate the tool	A-110
#601 Write to enable service reminder	A-111
#602 Write the lever start level	A-112
#603 Write the push start level	A-113
#604 Write the work light brightness	A-114
#606 Write the LED light settings	A-115
#607 Write the tool calibration	A-117
#650 Read the tool information	A-118
#651 Read the lever start level	A-119
#652 Read the push start level	A-120
#653 Read the work light brightness	A-122
#655 Read the LED light settings	A-123
#656 Read the tool calibration	A-125
A.3.7 Reports operations	A-126
#700 Clear the production report entries	A-127
#701 Clear the error and warning report entries.....	A-128
#750 Find and read the production report entries.....	A-129
#751 Find and read curves	A-132
#752 Find and read the error report entries	A-138
#753 Find and read the warning report entries	A-140

A.1 System structure

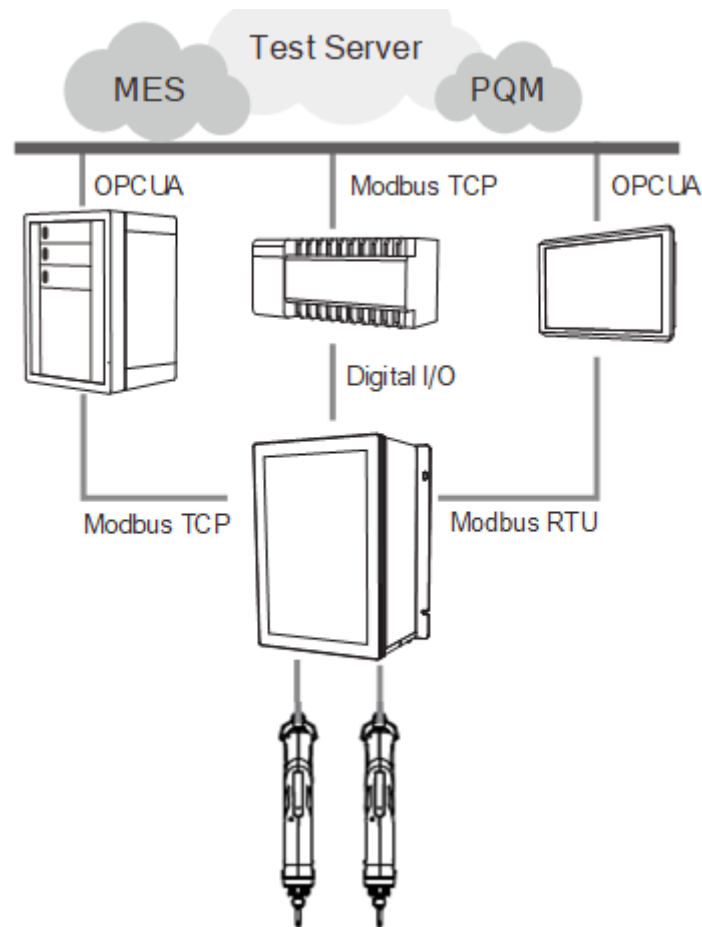

The ASA smart servo screwdriver system provides two communication protocols: Modbus TCP (Ethernet) and Modbus RTU (RS485). It allows peripheral IIoT equipment to obtain information from the controller, and then collect data to construct host computer systems, such as MES and PQM. The connection between the IIoT equipment and the smart servo screwdriver system is not limited by the hardware platform. Therefore, any equipment that supports Modbus protocol (such as PC, PLC, or HMI) is able to control the screwdriver system and obtain tightening data through the controller-defined Modbus handshake address table.

The Modbus handshake table consists of:

1. Operational status of the smart servo screwdriver system.
2. Handshake data of the smart servo screwdriver system.

Modbus TCP Slave

The smart servo screwdriver system supports Modbus TCP communications with the default IP: 192.168.1.11; Port: 502. After successfully connected, the system starts detecting the keepalive time. You need to maintain periodic data handshaking within 30 seconds; if there is no data handshaking within 30 seconds, the system will be automatically disconnected.

Modbus RTU Slave

The smart servo screwdriver system supports Modbus RTU (Remote Terminal Unit) communication. The default station number is 1, transmission speed is 9600, data bits are 8 bits, calibration bit is NONE, and stop bits are 2 bits.

The supported functions are: 03H read multiple Word data, 06H write single Word data, 10H write multiple Word data.

Start	Minimum silent interval: 10 ms
Slave Address	Communication address: 1 byte
Function	Function code: 1 byte
Data (n-1)	Data content: n word = 2n bytes, n ≤ 10 (the maximum words of single read/write is 10)
.....	
Data (0)	
CRC	Error check: 1 byte
End	Minimum silent interval: 10 ms

Note: in the RTU mode, there must be a minimum silent interval of 10 ms before and after transmission.

1. Function code 03H: read multiple Word data

The following example illustrates how the master station issues a read command to slave station no. 1:

The slave station reads 3 consecutive word data starting from address 0x00CF. The slave station then returns the content of 0x0096 read from address 0x00CF, 0x0001 read from address 0x00D0, and 0x0000 read from address 0x00D1. The maximum words of single read is 10.

Command message (Master):

Slave Address	01H
Function	03H
Starting data address	00H (high)
	CFH (low)
Number of data (in words)	00H
	03H
CRC Check Low	35H (low)
CRC Check High	F4H (high)

Response message (Slave):

Slave Address	01H
Function	03H
Number of data (in bytes)	06H
Content of starting data address 00CFH	00H (high)
	96H (low)
Content of second data address 00D0H	00H (high)
	01H (low)
Content of third data address 00D1H	00H (high)
	00H (low)
CRC Check Low	38H (low)
CRC Check High	A8H (high)

2. Function code 06H: write single Word data

The following example illustrates how the master station issues a write command to slave station no. 1:

The slave station writes the data 0x0064 to address 0x00C8, then responses to the master station after the writing is completed.



Command message (Master):

Address	01H
Slave Function	06H
Starting data address	00H (high)
	C8H (low)
Data content	00H (high)
	64H (low)
CRC Check Low	09H (low)
CRC Check High	DFH (high)

Response message (Slave):

Address	01H
Slave Function	06H
Starting data address	02H (high)
	00H (low)
Data content	00H (high)
	64H (low)
CRC Check Low	09H (low)
CRC Check High	DFH (high)

3. Function code 10H: write multiple Word data

The following example illustrates how the master station issues a write command to slave station no. 1:

The slave station writes 7 word data (0x0096, 0x0000, 0x0000, 0x0001, 0x0000, 0x0000, and 0x0001) respectively to 7 addresses starting from 0x00C8.

That is, the slave station writes 0x0096 to address 0x00C8, 0x0000 to address 0x00C9, 0x0000 to address 0x00CA, 0x0001 to address 0x00CB, 0x0000 to address 0x00CC, 0x0000 to address 0x00CD, and 0x0001 to address 0x00CE. The maximum words of single write is 10. The slave responses to the master after the writing is completed.

Command message (Master):

Slave Address	01H
Function	10H
Starting data address	00H (high)
	C8H (low)
Number of data (in words)	00H (high)
	07H (low)
Number of data (in bytes)	0EH
First data content	00H (high)
	96H (low)
Second data content	00H (high)
	00H (low)
Third data content	00H (high)
	00H (low)

Response message (Slave):

Slave Address	01H
Function	10H
Starting data address	00H (high)
	C8H (low)
Number of data (in words)	00H (high)
	07H (low)
CRC Check Low	00H (low)
CRC Check High	35H (high)

Fourth data content	00H (high)
	01H (low)
Fifth data content	00H (high)
	00H (low)
Sixth data content	00H (high)
	00H (low)
Seventh data content	00H (high)
	01H (low)
CRC Check Low	A2H (low)
CRC Check High	A6H (high)

4. CRC error check (RTU mode)

The following steps illustrate how to calculate the CRC error detection value:

Step 1: load a 16-bit register with the content FFFFH, and name the register as "CRC".

Step 2: perform Exclusive OR operation on the first byte of the command message with the low byte of the 16-bit CRC register, then return the result to the CRC register.

Step 3: check the least significant bit (LSB) in the CRC register. If the LSB is 0, shift the CRC register value to the right by one bit; if the LSB is 1, after shifting the CRC register value to the right by one bit, perform Exclusive OR operation on the shifted value with A001H. This step must be performed 8 times.

Step 4: repeat steps 2 to 3 until all bytes have been fully processed. The final content of the CRC register is the CRC value.

After the CRC value is calculated, place the lower bytes of the CRC value first, then the higher bytes into the command message. For example, if the calculated CRC value is 0xDF09, input 0x09 first and then 0xDF, as shown in the following table:

ARD	01H
CMD	06H
Starting data address	00H (high)
	C8H (low)
Number of data (in words)	00H (high)
	64H (low)
CRC Check Low	09H (low)
CRC Check High	DFH (high)

Example of CRC generating program

The following example uses the C language to generate the CRC value. This function requires two parameters:

```

unsigned char* data;
unsigned char length;
//This function returns the CRC value in unsigned integer.
unsigned int crc_chk(unsigned char* data, unsigned char length) {
    int j;
    unsigned int reg_crc=0xFFFF;

    while( length-- ) {
        reg_crc^= *data++;
        for (j=0; j<8; j++ ) {
            if( reg_crc & 0x01 ) { /*LSB(bit 0 ) = 1 */
                reg_crc = (reg_crc >> 1)^0xA001;
            } else {
                reg_crc = (reg_crc>>1);
            }
        }
    }
    return reg_crc;
}

```

A

Transmission process error report

The following is an example of the response message from slave station when an error occurs:

Slave Address	01H
Error code	83H
Exception code	04H
CRC Check Low	40H
CRC Check High	F3H

Descriptions of exception codes:

Exception code (1 Byte)	Description
01	Station number does not exist
02	Unable to recognize the function code: not 03, 06, or 10
03	Value error: the set value exceeds the maximum or minimum range
04	Exceeded the maximum words: the maximum words (10) for single access has been exceeded
05	Number error: accessed number is set as 0

Precautions:

1. Use either Modbus TCP Slave or Modbus RTU Slave; both of which share the same Modbus handshake addresses.
2. The Modbus address table in this manual is only applicable to the smart servo screwdriver system with the firmware version of 0031-0031-8097 or later.

A.2 Operational status of the smart servo screwdriver system

Obtain real-time information of the smart servo screwdriver system from the operational status area. The data refreshes every 0.3 seconds. Refer to the following Modbus address table.

Modbus (Hex)	Tool 1 status	R/W	Modbus (Hex)	Tool 1 status	R/W
0	Tightening ID set for cur. switch method	R	19	Clear the flag*	W
1	PAR/SEQ set for cur. switch method	R	1A	Total screw Qty. of current sequence (L)	R
2	SEQ ID of current switching method	R	1B	Total screw Qty. of current sequence (H)	R
3	PAR ID of current switching method	R	1C	Parameter Qty. of current sequence	R
4	Current target torque	R	1D	Screw Qty. of current parameter (L)	R
5	Current target angle	R	1E	Screw Qty. of current parameter (H)	R
6	Current parameter progress	R	1F	All screws of current parameter finished	R/W
7	Screw progress of current parameter (L)	R	20	Current parameter finished	R/W
8	Screw progress of current parameter (H)	R	21	Current screw finished	R/W
9	Screw progress of current sequence (L)	R	22	Setting parameters (Waiting...)	R
A	Screw progress of current sequence (H)	R	23	Final + Prevail torque	R
B	Tightening OK count (L)	R	24	Actual angle / total rundown angle	R
C	Tightening OK count (H)	R	25	Tightening angle	R
D	Single screw tightening NOK count (L)	R	26	Tightening result (1: OK; 2: NOK; 5: Pass)	R
E	Single screw tightening NOK count (H)	R	27	Loosening result (1: OK; 2: NOK)	R
F	Loosening OK count (L)	R	28	Curve creation finished	R/W
10	Loosening OK count (H)	R	29	Restrict tightening status	R
11	Single screw loosening NOK count (L)	R	2A	Parameter settings OK / NOK	R
12	Single screw loosening NOK count (H)	R	2B	Final torque	R
13	Final stage max. torque	R	2C	Prevail torque	R
14	Final stage min. torque	R	2D	Final current	R
15	Current torque unit	R	2E	Cause to restrict tightening operation*	R
16	-	-	2F	Cause to restrict loosening operation*	R
17	-	-	30	-	-
18	-	-	31	-	-

Modbus (Hex)	Tool 2 status	R/W	Modbus (Hex)	Tool 2 status	R/W
32	Tightening ID set for cur. switch method	R	4B	Clear the flag*	W
33	PAR/SEQ set for cur. switch method	R	4C	Total screw Qty. of current sequence (L)	R
34	SEQ ID of current switching method	R	4D	Total screw Qty. of current sequence (H)	R
35	PAR ID of current switching method	R	4E	Parameter Qty. of current sequence	R
36	Current target torque	R	4F	Screw Qty. of current parameter (L)	R
37	Current target angle	R	50	Screw Qty. of current parameter (H)	R
38	Current parameter progress	R	51	All screws of current parameter finished	R/W
39	Screw progress of current parameter (L)	R	52	Current parameter finished	R/W
3A	Screw progress of current parameter (H)	R	53	Current screw finished	R/W
3B	Screw progress of current sequence (L)	R	54	Setting parameters (Waiting...)	R
3C	Screw progress of current sequence (H)	R	55	Final + Prevail torque	R
3D	Tightening OK count (L)	R	56	Actual angle / total rundown angle	R
3E	Tightening OK count (H)	R	57	Tightening angle	R
3F	Single screw tightening NOK count (L)	R	58	Tightening result (1: OK; 2: NOK; 5: Pass)	R
40	Single screw tightening NOK count (H)	R	59	Loosening result (1: OK; 2: NOK)	R
41	Loosening OK count (L)	R	5A	Curve creation finished	R/W
42	Loosening OK count (H)	R	5B	Restrict tightening status	R
43	Single screw loosening NOK count (L)	R	5C	Parameter settings OK / NOK	R
44	Single screw loosening NOK count (H)	R	5D	Final torque	R
45	Final stage max. torque	R	5E	Prevail torque	R
46	Final stage min. torque	R	5F	Final current	R
47	Current torque unit	R	60	Cause to restrict tightening operation*	R
48	-	-	61	Cause to restrict loosening operation*	R
49	-	-	62	-	-
4A	-	-	63	-	-

A

Modbus (Hex)	Tool 1 / Tool 2 common status	R/W	Modbus (Hex)	Tool 1 / Tool 2 common status	R/W
64	Tool 1 servo / operation error / warning ID*	R	6F	Production report entry creation finished	R/W
65	Tool 2 servo / operation error / warning ID*	R	70	Clear the common flag*	W
66	DI status (Bit 1 - 8: Tool 1; Bit 9 - 16: Tool 2)	R	71	-	-
67	DO status (Bit 1 - 8: Tool 1; Bit 9 - 16: Tool 2)	R	72	All production report entries cleared	R/W
68	-	R	73	Start overwriting from production report ID 1	R/W
69	Current No. of error report entries	R	74	Start overwriting from error report ID 1	R/W
6A	Current No. of warning report entries	R	75	Start overwriting from warning report ID 1	R/W
6B	Current No. of production report entries (L)	R	76	Start overwriting from button report ID 1	R/W
6C	Current No. of production report entries (H)	R	77	Keepalive	R
6D	Current No. of button report entries (L)	R	78 to 95	-	-
6E	Current No. of button report entries (H)	R	-	-	-

*Note:

19	Clear the flag*	W
4B	Clear the flag*	W

Bit 0 : clear the "All screws of current parameter finished" flag (0x1F \ 0x51)

Bit 1 : clear the "Current parameter finished" flag (0x20 \ 0x52)

Bit 2 : clear the "Current screw finished" flag (0x21 \ 0x53)

Bit 3 : clear the "Curve creation finished" flag (0x28 \ 0x5A)

2E	Cause to restrict tightening operation*	R
60	Cause to restrict tightening operation*	R

Bit 0 : Max. count for single screw NOK tightening

Bit 1 : Prohibit tool operation when scanner string is null

Bit 2 : Prohibit tool operation when screw Qty. reached

Bit 3 : Max. operation time

Bit 4 : Incorrect parameter sequence

Bit 5 : Tightening operation restricted

Bit 6 : Parameter range error

2F	Cause to restrict loosening operation*	R
61	Cause to restrict loosening operation*	R

Bit 0 : Loosening prohibited after tightening OK

Bit 1 : Loosening prohibited after tightening NOK

Bit 2 : Max. count for single screw NOK loosening

Bit 3 : Incorrect parameter sequence

Bit 4 : Loosening operation restricted

Bit 5 : Parameter range error

64	Tool 1 servo / operation error / warning ID*	R
65	Tool 2 servo / operation error / warning ID*	R

0x1001 - 0x1999: Tool 1 servo error (AL); 0x2000 - 0x2999: Tool 2 servo error (AL)

0x3001 - 0x3999: Tool 1 operation error (NOK); 0x4000 - 0x4999: Tool 2 operation error (NOK)

0x5001 - 0x5999: Tool 1 warning ID (WN); 0x6000 - 0x6999: Tool 2 warning ID (WN)

70	Clear the common flag*	W
----	------------------------	---

Bit 0 : clear the "Production report entry creation finished" flag (0x6F)

Bit 1 : clear the "All production report entries cleared" flag (0x72)

Bit 2 : clear the "Start overwriting from production report ID 1" flag (0x73)

Bit 3 : clear the "Start overwriting from error report ID 1" flag (0x74)

Bit 4 : clear the "Start overwriting from warning report ID 1" flag (0x75)

Bit 5 : clear the "Start overwriting from button report ID 1" flag (0x76)

A

A.3 Handshake data of the smart servo screwdriver system

You can operate all functions of the controller with the function code table through handshaking.

All function codes are listed as follows:

A

Parameters			
Function code	Function name	Function code	Function name
#100	Write the parameters	#150	Read the parameters
Sequence			
Function code	Function name	Function code	Function name
#200	Write the sequence	#250	Read the sequence
Sources			
Function code	Function name	Function code	Function name
#300	Write the operation mode and switching method of Sources	#350	Read the operation mode and switching method of Sources
#301	Write the contents of single source settings	#351	Read the contents of single source settings
Results			
Function code	Function name	Function code	Function name
#400	Write the switching method of Sources	#450	Read the switching method of Sources
#401	Write the scanner string	#451	Read the scanner string
#402	Write to clear all errors	#452	Read the scanner advanced settings
#403	Write to reset the operation progress	-	-
#404	Write to execute the previous step	-	-
#405	Write to execute the next step	-	-
#406	Write to restrict tightening operation	-	-
#407	Write to restrict loosening operation	-	-
#408	Write the scanner advanced settings	-	-

A

Controller			
Function code	Function name	Function code	Function name
#500	Write the request for permissions login	#550	Read the Ethernet settings
#501	Write the request for password change	#551	Read the page permissions
#502	Write the request for permissions logout	#552	Read the firmware version
#503	Write the page permissions	#553	Read the DI/DO functions
#504	Write the Ethernet settings	#554	Read the DI/DO conversion table
#505	Request for factory reset	#555	Read the default torque unit
#506	Write the buzzer sound pattern	#556	Read the default tool start condition
#507	Write the DI/DO functions	-	-
#508	Write the DI/DO conversion table	-	-
#509	Write the default torque unit	-	-
#510	Write the default tool start condition	-	-

Tool			
Function code	Function name	Function code	Function name
#600	Write to activate the tool	#650	Read the tool information
#601	Write to enable service reminder	#651	Read the lever start level
#602	Write the lever start level	#652	Read the push start level
#603	Write the push start level	#653	Read the work light brightness
#604	Write the work light brightness	#654	Reserved
#605	Reserved	#655	Read the LED light settings
#606	Write the LED light settings	#656	Read the tool calibration
#607	Write the tool calibration	-	-

Reports			
#700	Clear the production report entries	#750	Find and read the production report entries
#701	Clear the error and warning report entries	#751	Find and read curves
-	-	#752	Find and read the error report entries
-	-	#753	Find and read the warning report entries

A.3.1 Parameters operations

Parameters			
Function code	Function name	Function code	Function name
#100	Write the parameters	#150	Read the parameters

#100 Write the parameters

Content description:

Use function code #100 to set the tightening parameters.

- A. Add a tightening parameter.
- B. Modify an existing tightening parameter. First, read the parameters with function code #150. After modifying the parameters, write the parameters with function code #100.

Handshake signal description:

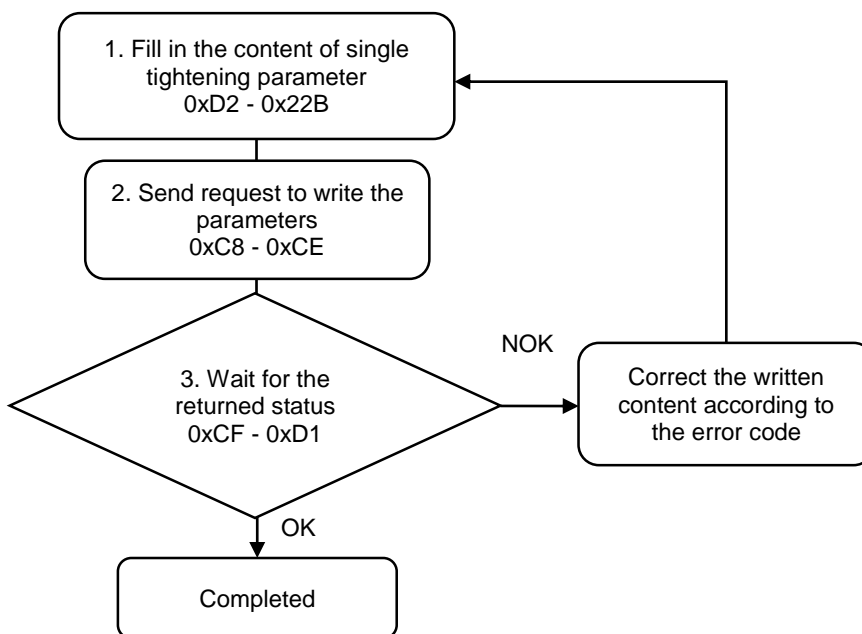

1. Fill in the tightening parameter content to 0xD2 - 0x22B.

Modbus (Hex)	Function	Description
D2 - E5	Parameter title (20 words)	ASCII code
E6	Min. tightening operation time	Unit: 0.1 second (< 3276.7 seconds)
E7	Hold time switch of the final stage	Whether to stay in the Servo ON state during the final stage (used with the Pause time setting)
E8	The prevail torque to be linked	The parameter ID to be linked
E9	Max. tightening time	Unit: 0.1 second (< 3276.7 seconds)
EA	Max. loosening time	Unit: 0.1 second (< 3276.7 seconds)
EB	Max. tightening angle	Unit: degree (< 32767 degrees)
EC	Max. loosening angle	Unit: degree (< 32767 degrees)
ED	Delay before tightening starts	Unit: 0.01 second

Modbus (Hex)						Function	Description
							(< 327.67 seconds)
EE						Delay before loosening starts	Unit: 0.01 second (< 327.67 seconds)
EF						Start torque for tightening angle calculation	Unit: 0.001 Nm
F0						Start torque for snug angle calculation	Unit: 0.0001 Nm
F1 - F9						Reserved	-
FA	12C	15E	190	1C2	1F4	Control mode	0: angle; 1: torque; 2: torque rate
FB	12D	15F	191	1C3	1F5	Tightening direction	0: CW; 1: CCW
FC	12E	160	192	1C4	1F6	Rotation speed	Unit: rpm
FD	12F	161	193	1C5	1F7	Target torque	Unit: 0.001 Nm
FE	130	162	194	1C6	1F8	Target angle	Unit: degree
FF	131	163	195	1C7	1F9	Target torque rate	Unit: 0.0001 Nm/degree
100	132	164	196	1C8	1FA	Angle interval for torque rate calculation	Unit: 0.1 degree
101	133	165	197	1C9	1FB	Acceleration time	Unit: ms
102	134	166	198	1CA	1FC	Max. angle	Unit: degree
103	135	167	199	1CB	1FD	Min. angle	Unit: degree
104	136	168	19A	1CC	1FE	Max. torque	Unit: 0.001 Nm
105	137	169	19B	1CD	1FF	Min. torque	Unit: 0.001 Nm
106	138	16A	19C	1CE	200	Max. operation time	Unit: 0.01 second
107	139	16B	19D	1CF	201	Min. operation time	Unit: 0.01 second
108	13A	16C	19E	1D0	202	Prevail torque On / Off	0: off; 1: on
109	13B	16D	19F	1D1	203	Angle range for prevail torque calculation	0 to 100%
10A	13C	16E	1A0	1D2	204	Pause time	Unit: ms
10B	13D	16F	1A1	1D3	205	Reserved	-
-	-	-	-	-	-		
12B	15D	18F	1C1	1F3	225		
226						First stage loosening angle	Unit: degree
227						First stage loosening speed	Unit: rpm
228						Second stage loosening angle	Unit: degree
229						Second stage loosening speed	Unit: rpm
22A						Loosening direction	0: CW; 1: CCW
22B						Detect loosening torque	Unit: 0.001 Nm

A

2. Fill in the write request to 0xC8 - 0xCE.

Modbus (Hex)	Write / Read request	Write
C8	Function code	100
C9	Version number	0
CA	Tool 1 / Tool 2	0: Tool 1; 1: Tool 2
CB	Parameter ID	1 (1 to 500)
CC	Reserved	-
CD	Reserved	-
CE	Request to send command	1 (fill in lastly)

3. Then check whether the writing is successful from the returned status in 0xCF - 0xD1.

Modbus (Hex)	Returned status	Description
CF	Function code	100
D0	Returned status	1: OK; 2: NOK
D1	Error code	Error code

If successful, the returned status (0xD0) is read as 1.

If failed, the returned status (0xD1) is read as 2. The error codes are as follows:

Code	Error description
1	Start: Max. torque < Min. torque
2	Start: Max. angle < Min. angle
3	Rundown: Max. torque < Min. torque
4	Rundown: Max. angle < Min. angle
5	Pre-tightening: Max. torque < Min. torque
6	Pre-tightening: Max. angle < Min. angle
7	Tightening: Max. torque < Min. torque
8	Tightening: Max. angle < Min. angle
9	Check if the stage sequence of the tightening settings is correct
10	No parameters set for this stage
11	Rundown: The set torque < Min. torque
12	Rundown: The set torque > Max. torque
13	Pre-tightening: The set torque < Min. torque
14	Pre-tightening: The set torque > Max. torque
15	Tightening: The set torque < Min. torque
16	Tightening: The set torque > Max. torque
17	The set angle > 32767
18	The set torque > Tool spec. torque The set min. torque > Tool spec. torque
19	The set torque > Tool max. torque
20	The set speed > Tool max. speed
21	Rundown: Torque cannot be 0
22	Pre-tightening: Torque cannot be 0
23	Tightening: Torque cannot be 0
24	The set rundown torque > The set pre-tightening torque

Code	Error description
25	The set rundown torque > The set tightening torque
26	The set pre-tightening torque > The set tightening torque
30	Tightening: The set speed < Min. speed
32	General: The set timeout > 32767
33	General: The set max. rotation angle > 32767
34	Start: Min. operation time > Max. operation time
35	Rundown: Min. operation time > Max. operation time
36	Pre-tightening: Min. operation time > Max. operation time
37	Tightening: Min. operation time > Max. operation time
38	General: The set tightening timeout > Max. operation time of the stage
39	Linked prevail torque cannot be 0
40	Cannot set multiple torque rates
47	Tightening speed > Pre-tightening speed
48	Start speed > Rundown speed
49	Pre-tightening speed > Rundown speed
50	Tightening speed > Rundown speed
51	Start: Max. torque > Tightening torque
52	Start: Min. torque > Tightening torque
53	Rundown: Max. torque > Tightening torque
54	Rundown: Min. torque > Tightening torque
55	Rundown: Max. torque > Tightening torque
56	Rundown: Min. torque > Tightening torque
57	Pre-tightening: Max. torque > Tightening torque
58	Pre-tightening: Min. torque > Tightening torque
61	The set torque < Min. torque
62	The set torque > Max. torque
63	Max. torque < Min. torque
64	Max. angle < Min. angle
65	Min. operation time > Max. operation time
100	Parameter ID (exceeds the range of 1 to 1500)
101	Tool 1 / Tool 2 (must be 0 or 1)
102	The title string is null
103	Title already exists

A

#150 Read the parameters

Content description:

Use function code #150 to read the tightening parameters.

- A. Obtain the content of existing tightening parameters.
- B. Check whether the tightening parameters have been set.

Handshake signal description:

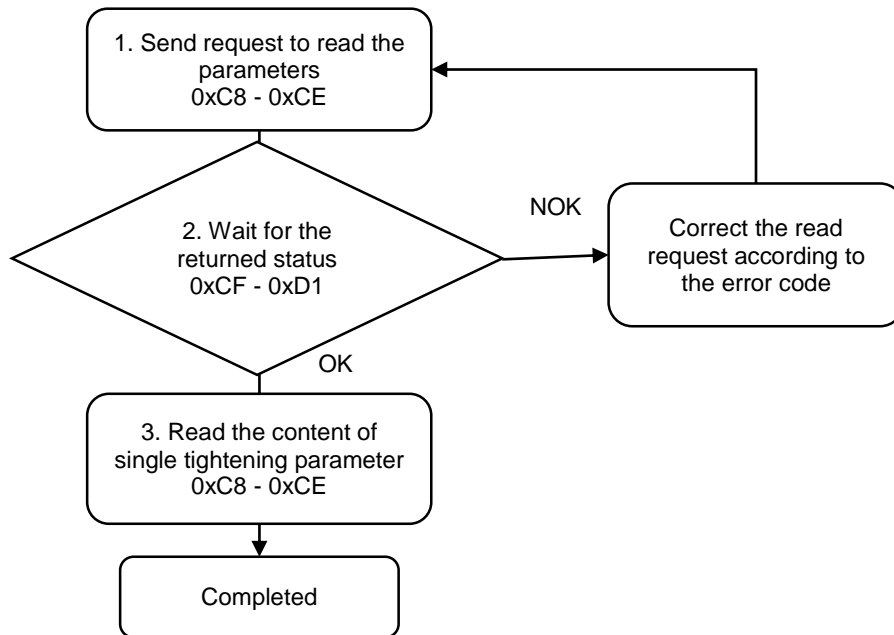

1. Fill in the read request to 0xC8 - 0xCE.

Modbus (Hex)	Write / Read request	Write
C8	Function code	150
C9	Version number	0
CA	0: Tool 1; 1: Tool 2	0 or 1
CB	Parameter ID	1 (1 to 500)
CC	Reserved	-
CD	Reserved	-
CE	Request to send command	1 (fill in lastly)

2. Check whether the reading is successful from the returned status in 0xCF - 0xD1.

Modbus (Hex)	Returned status	Description
CF	Function code	150
D0	Returned status	1: OK; 2: NOK
D1	Error code	Error code

If successful, the returned status (0xD0) is read as 1.

If failed, the returned status (0xD0) is read as 2. The error codes are as follows:

Code	Error description	Description
1	Parameter ID	Exceeds the range of 1 to 500
2	Tool 1 / Tool 2	Must be 0 or 1
3	Parameter content	Not set

3. Read the parameter content in 0xD2 - 0x22B.

Modbus (Hex)						Function	Description
D2 - E5						Parameter title (20 words)	ASCII code
E6						Reserved	-
E7						Hold time switch of the final stage	Whether to stay in the Servo ON state during the final stage (used with the Pause time setting)
E8						The prevail torque to be linked	The parameter ID to be linked
E9						Max. tightening time	Unit: 0.1 second (< 3276.7 seconds)
EA						Max. loosening time	Unit: 0.1 second (< 3276.7 seconds)
EB						Max. tightening angle	Unit: degree (< 32767 degrees)
EC						Max. loosening angle	Unit: degree (< 32767 degrees)
ED						Delay before tightening starts	Unit: 0.01 second (< 327.67 seconds)
EE						Delay before loosening starts	Unit: 0.01 second (< 327.67 seconds)
EF						Start torque for tightening angle calculation	Unit: 0.001 Nm
F0						Start torque for snug angle calculation	Unit: 0.0001 Nm
F1 - F9						Reserved	-
FA	12C	15E	190	1C2	1F4	Control mode	0: angle; 1: torque; 2: torque rate
FB	12D	15F	191	1C3	1F5	Tightening direction	0: CW; 1: CCW
FC	12E	160	192	1C4	1F6	Rotation speed	Unit: rpm
FD	12F	161	193	1C5	1F7	Target torque	Unit: 0.001 Nm
FE	130	162	194	1C6	1F8	Target angle	Unit: degree
FF	131	163	195	1C7	1F9	Target torque rate	Unit: 0.0001 Nm/degree
100	132	164	196	1C8	1FA	Angle interval for torque rate calculation	Unit: 0.1 degree
101	133	165	197	1C9	1FB	Acceleration time	Unit: ms
102	134	166	198	1CA	1FC	Max. angle	Unit: degree
103	135	167	199	1CB	1FD	Min. angle	Unit: degree
104	136	168	19A	1CC	1FE	Max. torque	Unit: 0.001 Nm
105	137	169	19B	1CD	1FF	Min. torque	Unit: 0.001 Nm
106	138	16A	19C	1CE	200	Max. operation time	Unit: 0.01 second

A

Modbus (Hex)						Function	Description
107	139	16B	19D	1CF	201	Min. operation time	Unit: 0.01 second
108	13A	16C	19E	1D0	202	Prevail torque On / Off	0: off; 1: on
109	13B	16D	19F	1D1	203	Angle range for prevail torque calculation	0 to 100%
10A	13C	16E	1A0	1D2	204	Pause time	Unit: ms
10B	13D	16F	1A1	1D3	205	Reserved	-
-	-	-	-	-	-		
12B	15D	18F	1C1	1F3	225		
226						First stage loosening angle	Unit: degree
227						First stage loosening speed	Unit: rpm
228						Second stage loosening angle	Unit: degree
229						Second stage loosening speed	Unit: rpm
22A						Loosening direction	0: CW; 1: CCW
22B						Detect loosening torque	Unit: 0.001 Nm

A

A.3.2 Sequence operations

Sequence			
Function code	Function name	Function code	Function name
#200	Write the sequence	#250	Read the sequence



#200 Write the sequence

Content description:

Use function code #200 to set the tightening sequence.

- A. Add a tightening sequence.
- B. Modify an existing tightening sequence. First, read the sequence with function code #250. After modifying the sequence, write the sequence with function code #200.

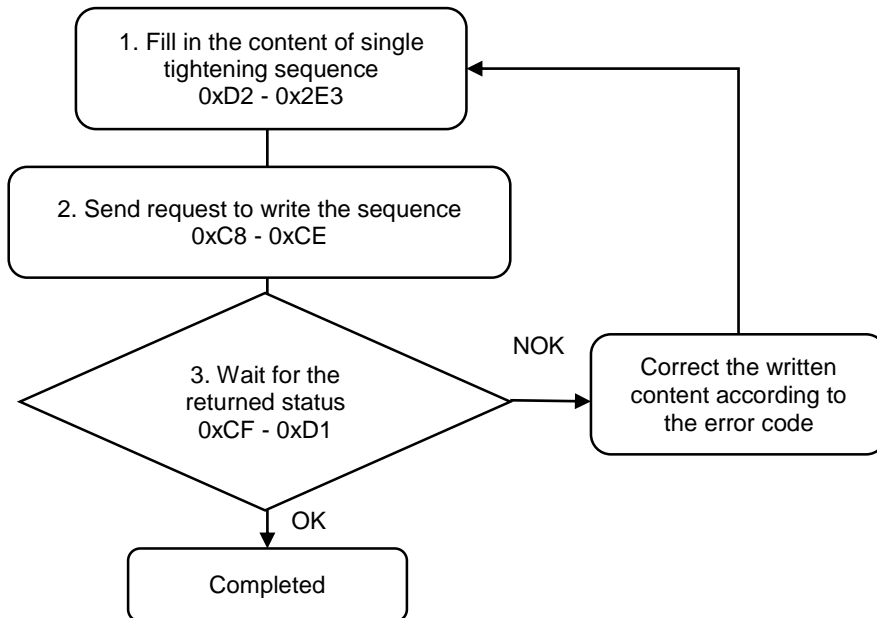

- 1. Fill in the tightening sequence content to 0xD2 - 0x2E3.

In each sequence, up to 100 sets of parameters can be arranged.

Modbus (Hex)	Function	Description
D2 - E5	Sequence title (20 words)	ASCII code
E6	General / Navigator mode	0: General mode 1: Navigator mode
E7 - EF	Reserved	-
F0	Tool ID for Set 1	0: Tool 1; 1: Tool 2
F1	Tool ID for Set 2	0: Tool 1; 1: Tool 2
F2	Tool ID for Set 3	0: Tool 1; 1: Tool 2
F3	Tool ID for Set 4	0: Tool 1; 1: Tool 2
F4	Tool ID for Set 5	0: Tool 1; 1: Tool 2
F5	Tool ID for Set 6	0: Tool 1; 1: Tool 2
F6	Tool ID for Set 7	0: Tool 1; 1: Tool 2
F7	Tool ID for Set 8	0: Tool 1; 1: Tool 2

Modbus (Hex)	Function	Description
F8	Tool ID for Set 9	0: Tool 1; 1: Tool 2
F9	Tool ID for Set 10	0: Tool 1; 1: Tool 2
FA	Tool ID for Set 11	0: Tool 1; 1: Tool 2
FB	Tool ID for Set 12	0: Tool 1; 1: Tool 2
FC	Tool ID for Set 13	0: Tool 1; 1: Tool 2
FD	Tool ID for Set 14	0: Tool 1; 1: Tool 2
FE	Tool ID for Set 15	0: Tool 1; 1: Tool 2
FF	Tool ID for Set 16	0: Tool 1; 1: Tool 2
100	Tool ID for Set 17	0: Tool 1; 1: Tool 2
101	Tool ID for Set 18	0: Tool 1; 1: Tool 2
102	Tool ID for Set 19	0: Tool 1; 1: Tool 2
103	Tool ID for Set 20	0: Tool 1; 1: Tool 2
104	Tool ID for Set 21	0: Tool 1; 1: Tool 2
105	Tool ID for Set 22	0: Tool 1; 1: Tool 2
106	Tool ID for Set 23	0: Tool 1; 1: Tool 2
107	Tool ID for Set 24	0: Tool 1; 1: Tool 2
108	Tool ID for Set 25	0: Tool 1; 1: Tool 2
109	Tool ID for Set 26	0: Tool 1; 1: Tool 2
10A	Tool ID for Set 27	0: Tool 1; 1: Tool 2
10B	Tool ID for Set 28	0: Tool 1; 1: Tool 2
10C	Tool ID for Set 29	0: Tool 1; 1: Tool 2
10D	Tool ID for Set 30	0: Tool 1; 1: Tool 2
10E	Tool ID for Set 31	0: Tool 1; 1: Tool 2
10F	Tool ID for Set 32	0: Tool 1; 1: Tool 2
110	Tool ID for Set 33	0: Tool 1; 1: Tool 2
111	Tool ID for Set 34	0: Tool 1; 1: Tool 2
112	Tool ID for Set 35	0: Tool 1; 1: Tool 2
113	Tool ID for Set 36	0: Tool 1; 1: Tool 2
114	Tool ID for Set 37	0: Tool 1; 1: Tool 2
115	Tool ID for Set 38	0: Tool 1; 1: Tool 2
116	Tool ID for Set 39	0: Tool 1; 1: Tool 2
117	Tool ID for Set 40	0: Tool 1; 1: Tool 2
118	Tool ID for Set 41	0: Tool 1; 1: Tool 2
119	Tool ID for Set 42	0: Tool 1; 1: Tool 2
11A	Tool ID for Set 43	0: Tool 1; 1: Tool 2
11B	Tool ID for Set 44	0: Tool 1; 1: Tool 2
11C	Tool ID for Set 45	0: Tool 1; 1: Tool 2
11D	Tool ID for Set 46	0: Tool 1; 1: Tool 2
11E	Tool ID for Set 47	0: Tool 1; 1: Tool 2
11F	Tool ID for Set 48	0: Tool 1; 1: Tool 2
120	Tool ID for Set 49	0: Tool 1; 1: Tool 2
121	Tool ID for Set 50	0: Tool 1; 1: Tool 2
122	Tool ID for Set 51	0: Tool 1; 1: Tool 2

Modbus (Hex)	Function	Description
123	Tool ID for Set 52	0: Tool 1; 1: Tool 2
124	Tool ID for Set 53	0: Tool 1; 1: Tool 2
125	Tool ID for Set 54	0: Tool 1; 1: Tool 2
126	Tool ID for Set 55	0: Tool 1; 1: Tool 2
127	Tool ID for Set 56	0: Tool 1; 1: Tool 2
128	Tool ID for Set 57	0: Tool 1; 1: Tool 2
129	Tool ID for Set 58	0: Tool 1; 1: Tool 2
12A	Tool ID for Set 59	0: Tool 1; 1: Tool 2
12B	Tool ID for Set 60	0: Tool 1; 1: Tool 2
12C	Tool ID for Set 61	0: Tool 1; 1: Tool 2
12D	Tool ID for Set 62	0: Tool 1; 1: Tool 2
12E	Tool ID for Set 63	0: Tool 1; 1: Tool 2
12F	Tool ID for Set 64	0: Tool 1; 1: Tool 2
130	Tool ID for Set 65	0: Tool 1; 1: Tool 2
131	Tool ID for Set 66	0: Tool 1; 1: Tool 2
132	Tool ID for Set 67	0: Tool 1; 1: Tool 2
133	Tool ID for Set 68	0: Tool 1; 1: Tool 2
134	Tool ID for Set 69	0: Tool 1; 1: Tool 2
135	Tool ID for Set 70	0: Tool 1; 1: Tool 2
136	Tool ID for Set 71	0: Tool 1; 1: Tool 2
137	Tool ID for Set 72	0: Tool 1; 1: Tool 2
138	Tool ID for Set 73	0: Tool 1; 1: Tool 2
139	Tool ID for Set 74	0: Tool 1; 1: Tool 2
13A	Tool ID for Set 75	0: Tool 1; 1: Tool 2
13B	Tool ID for Set 76	0: Tool 1; 1: Tool 2
13C	Tool ID for Set 77	0: Tool 1; 1: Tool 2
13D	Tool ID for Set 78	0: Tool 1; 1: Tool 2
13E	Tool ID for Set 79	0: Tool 1; 1: Tool 2
13F	Tool ID for Set 80	0: Tool 1; 1: Tool 2
140	Tool ID for Set 81	0: Tool 1; 1: Tool 2
141	Tool ID for Set 82	0: Tool 1; 1: Tool 2
142	Tool ID for Set 83	0: Tool 1; 1: Tool 2
143	Tool ID for Set 84	0: Tool 1; 1: Tool 2
144	Tool ID for Set 85	0: Tool 1; 1: Tool 2
145	Tool ID for Set 86	0: Tool 1; 1: Tool 2
146	Tool ID for Set 87	0: Tool 1; 1: Tool 2
147	Tool ID for Set 88	0: Tool 1; 1: Tool 2
148	Tool ID for Set 89	0: Tool 1; 1: Tool 2
149	Tool ID for Set 90	0: Tool 1; 1: Tool 2
14A	Tool ID for Set 91	0: Tool 1; 1: Tool 2
14B	Tool ID for Set 92	0: Tool 1; 1: Tool 2
14C	Tool ID for Set 93	0: Tool 1; 1: Tool 2

A

Modbus (Hex)	Function	Description
14D	Tool ID for Set 94	0: Tool 1; 1: Tool 2
14E	Tool ID for Set 95	0: Tool 1; 1: Tool 2
14F	Tool ID for Set 96	0: Tool 1; 1: Tool 2
150	Tool ID for Set 97	0: Tool 1; 1: Tool 2
151	Tool ID for Set 98	0: Tool 1; 1: Tool 2
152	Tool ID for Set 99	0: Tool 1; 1: Tool 2
153	Tool ID for Set 100	0: Tool 1; 1: Tool 2
154	Parameter ID for Set 1	1 to 500
155	Parameter ID for Set 2	1 to 500
156	Parameter ID for Set 3	1 to 500
157	Parameter ID for Set 4	1 to 500
158	Parameter ID for Set 5	1 to 500
159	Parameter ID for Set 6	1 to 500
15A	Parameter ID for Set 7	1 to 500
15B	Parameter ID for Set 8	1 to 500
15C	Parameter ID for Set 9	1 to 500
15D	Parameter ID for Set 10	1 to 500
15E	Parameter ID for Set 11	1 to 500
15F	Parameter ID for Set 12	1 to 500
160	Parameter ID for Set 13	1 to 500
161	Parameter ID for Set 14	1 to 500
162	Parameter ID for Set 15	1 to 500
163	Parameter ID for Set 16	1 to 500
164	Parameter ID for Set 17	1 to 500
165	Parameter ID for Set 18	1 to 500
166	Parameter ID for Set 19	1 to 500
167	Parameter ID for Set 20	1 to 500
168	Parameter ID for Set 21	1 to 500
169	Parameter ID for Set 22	1 to 500
16A	Parameter ID for Set 23	1 to 500
16B	Parameter ID for Set 24	1 to 500
16C	Parameter ID for Set 25	1 to 500
16D	Parameter ID for Set 26	1 to 500
16E	Parameter ID for Set 27	1 to 500
16F	Parameter ID for Set 28	1 to 500
170	Parameter ID for Set 29	1 to 500
171	Parameter ID for Set 30	1 to 500
172	Parameter ID for Set 31	1 to 500
173	Parameter ID for Set 32	1 to 500
174	Parameter ID for Set 33	1 to 500
175	Parameter ID for Set 34	1 to 500
176	Parameter ID for Set 35	1 to 500
177	Parameter ID for Set 36	1 to 500

Modbus (Hex)	Function	Description
178	Parameter ID for Set 37	1 to 500
179	Parameter ID for Set 38	1 to 500
17A	Parameter ID for Set 39	1 to 500
17B	Parameter ID for Set 40	1 to 500
17C	Parameter ID for Set 41	1 to 500
17D	Parameter ID for Set 42	1 to 500
17E	Parameter ID for Set 43	1 to 500
17F	Parameter ID for Set 44	1 to 500
180	Parameter ID for Set 45	1 to 500
181	Parameter ID for Set 46	1 to 500
182	Parameter ID for Set 47	1 to 500
183	Parameter ID for Set 48	1 to 500
184	Parameter ID for Set 49	1 to 500
185	Parameter ID for Set 50	1 to 500
186	Parameter ID for Set 51	1 to 500
187	Parameter ID for Set 52	1 to 500
188	Parameter ID for Set 53	1 to 500
189	Parameter ID for Set 54	1 to 500
18A	Parameter ID for Set 55	1 to 500
18B	Parameter ID for Set 56	1 to 500
18C	Parameter ID for Set 57	1 to 500
18D	Parameter ID for Set 58	1 to 500
18E	Parameter ID for Set 59	1 to 500
18F	Parameter ID for Set 60	1 to 500
190	Parameter ID for Set 61	1 to 500
191	Parameter ID for Set 62	1 to 500
192	Parameter ID for Set 63	1 to 500
193	Parameter ID for Set 64	1 to 500
194	Parameter ID for Set 65	1 to 500
195	Parameter ID for Set 66	1 to 500
196	Parameter ID for Set 67	1 to 500
197	Parameter ID for Set 68	1 to 500
198	Parameter ID for Set 69	1 to 500
199	Parameter ID for Set 70	1 to 500
19A	Parameter ID for Set 71	1 to 500
19B	Parameter ID for Set 72	1 to 500
19C	Parameter ID for Set 73	1 to 500
19D	Parameter ID for Set 74	1 to 500
19E	Parameter ID for Set 75	1 to 500
19F	Parameter ID for Set 76	1 to 500
1A0	Parameter ID for Set 77	1 to 500
1A1	Parameter ID for Set 78	1 to 500

A

Modbus (Hex)	Function	Description
1A2	Parameter ID for Set 79	1 to 500
1A3	Parameter ID for Set 80	1 to 500
1A4	Parameter ID for Set 81	1 to 500
1A5	Parameter ID for Set 82	1 to 500
1A6	Parameter ID for Set 83	1 to 500
1A7	Parameter ID for Set 84	1 to 500
1A8	Parameter ID for Set 85	1 to 500
1A9	Parameter ID for Set 86	1 to 500
1AA	Parameter ID for Set 87	1 to 500
1AB	Parameter ID for Set 88	1 to 500
1AC	Parameter ID for Set 89	1 to 500
1AD	Parameter ID for Set 90	1 to 500
1AE	Parameter ID for Set 91	1 to 500
1AF	Parameter ID for Set 92	1 to 500
1B0	Parameter ID for Set 93	1 to 500
1B1	Parameter ID for Set 94	1 to 500
1B2	Parameter ID for Set 95	1 to 500
1B3	Parameter ID for Set 96	1 to 500
1B4	Parameter ID for Set 97	1 to 500
1B5	Parameter ID for Set 98	1 to 500
1B6	Parameter ID for Set 99	1 to 500
1B7	Parameter ID for Set 100	1 to 500
1B8	Screw quantity for Set 1 (L)	1 to 999999
1B9	Screw quantity for Set 1 (H)	
1BA	Screw quantity for Set 2 (L)	1 to 999999
1BB	Screw quantity for Set 2 (H)	
1BC	Screw quantity for Set 3 (L)	1 to 999999
1BD	Screw quantity for Set 3 (H)	
1BE	Screw quantity for Set 4 (L)	1 to 999999
1BF	Screw quantity for Set 4 (H)	
1C0	Screw quantity for Set 5 (L)	1 to 999999
1C1	Screw quantity for Set 5 (H)	
1C2	Screw quantity for Set 6 (L)	1 to 999999
1C3	Screw quantity for Set 6 (H)	
1C4	Screw quantity for Set 7 (L)	1 to 999999
1C5	Screw quantity for Set 7 (H)	
1C6	Screw quantity for Set 8 (L)	1 to 999999
1C7	Screw quantity for Set 8 (H)	
1C8	Screw quantity for Set 9 (L)	1 to 999999
1C9	Screw quantity for Set 9 (H)	
1CA	Screw quantity for Set 10 (L)	1 to 999999
1CB	Screw quantity for Set 10 (H)	
1CC	Screw quantity for Set 11 (L)	1 to 999999

Modbus (Hex)	Function	Description
1CD	Screw quantity for Set 11 (H)	
1CE	Screw quantity for Set 12 (L)	1 to 999999
1CF	Screw quantity for Set 12 (H)	
1D0	Screw quantity for Set 13 (L)	1 to 999999
1D1	Screw quantity for Set 13 (H)	
1D2	Screw quantity for Set 14 (L)	1 to 999999
1D3	Screw quantity for Set 14 (H)	
1D4	Screw quantity for Set 15 (L)	1 to 999999
1D5	Screw quantity for Set 15 (H)	
1D6	Screw quantity for Set 16 (L)	1 to 999999
1D7	Screw quantity for Set 16 (H)	
1D8	Screw quantity for Set 17 (L)	1 to 999999
1D9	Screw quantity for Set 17 (H)	
1DA	Screw quantity for Set 18 (L)	1 to 999999
1DB	Screw quantity for Set 18 (H)	
1DC	Screw quantity for Set 19 (L)	1 to 999999
1DD	Screw quantity for Set 19 (H)	
1DE	Screw quantity for Set 20 (L)	1 to 999999
1DF	Screw quantity for Set 20 (H)	
1E0	Screw quantity for Set 21 (L)	1 to 999999
1E1	Screw quantity for Set 21 (H)	
1E2	Screw quantity for Set 22 (L)	1 to 999999
1E3	Screw quantity for Set 22 (H)	
1E4	Screw quantity for Set 23 (L)	1 to 999999
1E5	Screw quantity for Set 23 (H)	
1E6	Screw quantity for Set 24 (L)	1 to 999999
1E7	Screw quantity for Set 24 (H)	
1E8	Screw quantity for Set 25 (L)	1 to 999999
1E9	Screw quantity for Set 25 (H)	
1EA	Screw quantity for Set 26 (L)	1 to 999999
1EB	Screw quantity for Set 26 (H)	
1EC	Screw quantity for Set 27 (L)	1 to 999999
1ED	Screw quantity for Set 27 (H)	
1EE	Screw quantity for Set 28 (L)	1 to 999999
1EF	Screw quantity for Set 28 (H)	
1F0	Screw quantity for Set 29 (L)	1 to 999999
1F1	Screw quantity for Set 29 (H)	
1F2	Screw quantity for Set 30 (L)	1 to 999999
1F3	Screw quantity for Set 30 (H)	
1F4	Screw quantity for Set 31 (L)	1 to 999999
1F5	Screw quantity for Set 31 (H)	
1F6	Screw quantity for Set 32 (L)	1 to 999999

A

Modbus (Hex)	Function	Description
1F7	Screw quantity for Set 32 (H)	
1F8	Screw quantity for Set 33 (L)	1 to 999999
1F9	Screw quantity for Set 33 (H)	
1FA	Screw quantity for Set 34 (L)	1 to 999999
1FB	Screw quantity for Set 34 (H)	
1FC	Screw quantity for Set 35 (L)	1 to 999999
1FD	Screw quantity for Set 35 (H)	
1FE	Screw quantity for Set 36 (L)	1 to 999999
1FF	Screw quantity for Set 36 (H)	
200	Screw quantity for Set 37 (L)	1 to 999999
201	Screw quantity for Set 37 (H)	
202	Screw quantity for Set 38 (L)	1 to 999999
203	Screw quantity for Set 38 (H)	
204	Screw quantity for Set 39 (L)	1 to 999999
205	Screw quantity for Set 39 (H)	
206	Screw quantity for Set 40 (L)	1 to 999999
207	Screw quantity for Set 40 (H)	
208	Screw quantity for Set 41 (L)	1 to 999999
209	Screw quantity for Set 41 (H)	
20A	Screw quantity for Set 42 (L)	1 to 999999
20B	Screw quantity for Set 42 (H)	
20C	Screw quantity for Set 43 (L)	1 to 999999
20D	Screw quantity for Set 43 (H)	
20E	Screw quantity for Set 44 (L)	1 to 999999
20F	Screw quantity for Set 44 (H)	
210	Screw quantity for Set 45 (L)	1 to 999999
211	Screw quantity for Set 45 (H)	
212	Screw quantity for Set 46 (L)	1 to 999999
213	Screw quantity for Set 46 (H)	
214	Screw quantity for Set 47 (L)	1 to 999999
215	Screw quantity for Set 47 (H)	
216	Screw quantity for Set 48 (L)	1 to 999999
217	Screw quantity for Set 48 (H)	
218	Screw quantity for Set 49 (L)	1 to 999999
219	Screw quantity for Set 49 (H)	
21A	Screw quantity for Set 50 (L)	1 to 999999
21B	Screw quantity for Set 50 (H)	
21C	Screw quantity for Set 51 (L)	1 to 999999
21D	Screw quantity for Set 51 (H)	
21E	Screw quantity for Set 52 (L)	1 to 999999
21F	Screw quantity for Set 52 (H)	

Modbus (Hex)	Function	Description
220	Screw quantity for Set 53 (L)	1 to 999999
221	Screw quantity for Set 53 (H)	
222	Screw quantity for Set 54 (L)	1 to 999999
223	Screw quantity for Set 54 (H)	
224	Screw quantity for Set 55 (L)	1 to 999999
225	Screw quantity for Set 55 (H)	
226	Screw quantity for Set 56 (L)	1 to 999999
227	Screw quantity for Set 56 (H)	
228	Screw quantity for Set 57 (L)	1 to 999999
229	Screw quantity for Set 57 (H)	
22A	Screw quantity for Set 58 (L)	1 to 999999
22B	Screw quantity for Set 58 (H)	
22C	Screw quantity for Set 59 (L)	1 to 999999
22D	Screw quantity for Set 59 (H)	
22E	Screw quantity for Set 60 (L)	1 to 999999
22F	Screw quantity for Set 60 (H)	
230	Screw quantity for Set 61 (L)	1 to 999999
231	Screw quantity for Set 61 (H)	
232	Screw quantity for Set 62 (L)	1 to 999999
233	Screw quantity for Set 62 (H)	
234	Screw quantity for Set 63 (L)	1 to 999999
235	Screw quantity for Set 63 (H)	
236	Screw quantity for Set 64 (L)	1 to 999999
237	Screw quantity for Set 64 (H)	
238	Screw quantity for Set 65 (L)	1 to 999999
239	Screw quantity for Set 65 (H)	
23A	Screw quantity for Set 66 (L)	1 to 999999
23B	Screw quantity for Set 66 (H)	
23C	Screw quantity for Set 67 (L)	1 to 999999
23D	Screw quantity for Set 67 (H)	
23E	Screw quantity for Set 68 (L)	1 to 999999
23F	Screw quantity for Set 68 (H)	
240	Screw quantity for Set 69 (L)	1 to 999999
241	Screw quantity for Set 69 (H)	
242	Screw quantity for Set 70 (L)	1 to 999999
243	Screw quantity for Set 70 (H)	
244	Screw quantity for Set 71 (L)	1 to 999999
245	Screw quantity for Set 71 (H)	
246	Screw quantity for Set 72 (L)	1 to 999999
247	Screw quantity for Set 72 (H)	
248	Screw quantity for Set 73 (L)	1 to 999999
249	Screw quantity for Set 73 (H)	

A

Modbus (Hex)	Function	Description
24A	Screw quantity for Set 74 (L)	1 to 999999
24B	Screw quantity for Set 74 (H)	
24C	Screw quantity for Set 75 (L)	1 to 999999
24D	Screw quantity for Set 75 (H)	
24E	Screw quantity for Set 76 (L)	1 to 999999
24F	Screw quantity for Set 76 (H)	
250	Screw quantity for Set 77 (L)	1 to 999999
251	Screw quantity for Set 77 (H)	
252	Screw quantity for Set 78 (L)	1 to 999999
253	Screw quantity for Set 78 (H)	
254	Screw quantity for Set 79 (L)	1 to 999999
255	Screw quantity for Set 79 (H)	
256	Screw quantity for Set 80 (L)	1 to 999999
257	Screw quantity for Set 80 (H)	
258	Screw quantity for Set 81 (L)	1 to 999999
259	Screw quantity for Set 81 (H)	
25A	Screw quantity for Set 82 (L)	1 to 999999
25B	Screw quantity for Set 82 (H)	
25C	Screw quantity for Set 83 (L)	1 to 999999
25D	Screw quantity for Set 83 (H)	
25E	Screw quantity for Set 84 (L)	1 to 999999
25F	Screw quantity for Set 84 (H)	
260	Screw quantity for Set 85 (L)	1 to 999999
261	Screw quantity for Set 85 (H)	
262	Screw quantity for Set 86 (L)	1 to 999999
263	Screw quantity for Set 86 (H)	
264	Screw quantity for Set 87 (L)	1 to 999999
265	Screw quantity for Set 87 (H)	
266	Screw quantity for Set 88 (L)	1 to 999999
267	Screw quantity for Set 88 (H)	
268	Screw quantity for Set 89 (L)	1 to 999999
269	Screw quantity for Set 89 (H)	
26A	Screw quantity for Set 90 (L)	1 to 999999
26B	Screw quantity for Set 90 (H)	
26C	Screw quantity for Set 91 (L)	1 to 999999
26D	Screw quantity for Set 91 (H)	
26E	Screw quantity for Set 92 (L)	1 to 999999
26F	Screw quantity for Set 92 (H)	
270	Screw quantity for Set 93 (L)	1 to 999999
271	Screw quantity for Set 93 (H)	
272	Screw quantity for Set 94 (L)	1 to 999999
273	Screw quantity for Set 94 (H)	

A

Modbus (Hex)	Function	Description
274	Screw quantity for Set 95 (L)	1 to 999999
275	Screw quantity for Set 95 (H)	
276	Screw quantity for Set 96 (L)	1 to 999999
277	Screw quantity for Set 96 (H)	
278	Screw quantity for Set 97 (L)	1 to 999999
279	Screw quantity for Set 97 (H)	
27A	Screw quantity for Set 98 (L)	1 to 999999
27B	Screw quantity for Set 98 (H)	
27C	Screw quantity for Set 99 (L)	1 to 999999
27D	Screw quantity for Set 99 (H)	
27E	Screw quantity for Set 100 (L)	1 to 999999
27F	Screw quantity for Set 100 (H)	
280	Bit ID for Set 1	0 to 255
281	Bit ID for Set 2	0 to 255
282	Bit ID for Set 3	0 to 255
283	Bit ID for Set 4	0 to 255
284	Bit ID for Set 5	0 to 255
285	Bit ID for Set 6	0 to 255
286	Bit ID for Set 7	0 to 255
287	Bit ID for Set 8	0 to 255
288	Bit ID for Set 9	0 to 255
289	Bit ID for Set 10	0 to 255
28A	Bit ID for Set 11	0 to 255
28B	Bit ID for Set 12	0 to 255
28C	Bit ID for Set 13	0 to 255
28D	Bit ID for Set 14	0 to 255
28E	Bit ID for Set 15	0 to 255
28F	Bit ID for Set 16	0 to 255
290	Bit ID for Set 17	0 to 255
291	Bit ID for Set 18	0 to 255
292	Bit ID for Set 19	0 to 255
293	Bit ID for Set 20	0 to 255
294	Bit ID for Set 21	0 to 255
295	Bit ID for Set 22	0 to 255
296	Bit ID for Set 23	0 to 255
297	Bit ID for Set 24	0 to 255
298	Bit ID for Set 25	0 to 255
299	Bit ID for Set 26	0 to 255
29A	Bit ID for Set 27	0 to 255
29B	Bit ID for Set 28	0 to 255
29C	Bit ID for Set 29	0 to 255
29D	Bit ID for Set 30	0 to 255

A

Modbus (Hex)	Function	Description
29E	Bit ID for Set 31	0 to 255
29F	Bit ID for Set 32	0 to 255
2A0	Bit ID for Set 33	0 to 255
2A1	Bit ID for Set 34	0 to 255
2A2	Bit ID for Set 35	0 to 255
2A3	Bit ID for Set 36	0 to 255
2A4	Bit ID for Set 37	0 to 255
2A5	Bit ID for Set 38	0 to 255
2A6	Bit ID for Set 39	0 to 255
2A7	Bit ID for Set 40	0 to 255
2A8	Bit ID for Set 41	0 to 255
2A9	Bit ID for Set 42	0 to 255
2AA	Bit ID for Set 43	0 to 255
2AB	Bit ID for Set 44	0 to 255
2AC	Bit ID for Set 45	0 to 255
2AD	Bit ID for Set 46	0 to 255
2AE	Bit ID for Set 47	0 to 255
2AF	Bit ID for Set 48	0 to 255
2B0	Bit ID for Set 49	0 to 255
2B1	Bit ID for Set 50	0 to 255
2B2	Bit ID for Set 51	0 to 255
2B3	Bit ID for Set 52	0 to 255
2B4	Bit ID for Set 53	0 to 255
2B5	Bit ID for Set 54	0 to 255
2B6	Bit ID for Set 55	0 to 255
2B7	Bit ID for Set 56	0 to 255
2B8	Bit ID for Set 57	0 to 255
2B9	Bit ID for Set 58	0 to 255
2BA	Bit ID for Set 59	0 to 255
2BB	Bit ID for Set 60	0 to 255
2BC	Bit ID for Set 61	0 to 255
2BD	Bit ID for Set 62	0 to 255
2BE	Bit ID for Set 63	0 to 255
2BF	Bit ID for Set 64	0 to 255
2C0	Bit ID for Set 65	0 to 255
2C1	Bit ID for Set 66	0 to 255
2C2	Bit ID for Set 67	0 to 255
2C3	Bit ID for Set 68	0 to 255
2C4	Bit ID for Set 69	0 to 255
2C5	Bit ID for Set 70	0 to 255
2C6	Bit ID for Set 71	0 to 255
2C7	Bit ID for Set 72	0 to 255
2C8	Bit ID for Set 73	0 to 255

Modbus (Hex)	Function	Description
2C9	Bit ID for Set 74	0 to 255
2CA	Bit ID for Set 75	0 to 255
2CB	Bit ID for Set 76	0 to 255
2CC	Bit ID for Set 77	0 to 255
2CD	Bit ID for Set 78	0 to 255
2CE	Bit ID for Set 79	0 to 255
2CF	Bit ID for Set 80	0 to 255
2D0	Bit ID for Set 81	0 to 255
2D1	Bit ID for Set 82	0 to 255
2D2	Bit ID for Set 83	0 to 255
2D3	Bit ID for Set 84	0 to 255
2D4	Bit ID for Set 85	0 to 255
2D5	Bit ID for Set 86	0 to 255
2D6	Bit ID for Set 87	0 to 255
2D7	Bit ID for Set 88	0 to 255
2D8	Bit ID for Set 89	0 to 255
2D9	Bit ID for Set 90	0 to 255
2DA	Bit ID for Set 91	0 to 255
2DB	Bit ID for Set 92	0 to 255
2DC	Bit ID for Set 93	0 to 255
2DD	Bit ID for Set 94	0 to 255
2DE	Bit ID for Set 95	0 to 255
2DF	Bit ID for Set 96	0 to 255
2E0	Bit ID for Set 97	0 to 255
2E1	Bit ID for Set 98	0 to 255
2E2	Bit ID for Set 99	0 to 255
2E3	Bit ID for Set 100	0 to 255

2. Fill in the write request to 0xC8 - 0xCE.

Modbus (Hex)	Write / Read request	Write
C8	Function code	200
C9	Version number	0
CA	Sequence ID	1 (1 to 500)
CB	Reserved	-
CC	Reserved	-
CD	Reserved	-
CE	Request to send command	1 (fill in lastly)

A

3. Then check whether the writing is successful from the returned status in 0xCF - 0xD1.

Modbus (Hex)	Returned status	Description
CF	Function code	200
D0	Returned status	1: OK; 2: NOK
D1	Error code	Error code

If successful, the returned status (0xD0) is read as 1.

If failed, the returned status (0xD1) is read as 2. The error codes are as follows:

Code	Error description	Description
1	Sequence ID	Exceeds the range of 1 to 500
2	The quantity is 0	Cannot be set as 0
3	Total screw quantity > 999999	Cannot exceed 999999
100	The title string is null	-
101	Title already exists	-

#250 Read the sequence

Content description:

Use function code #250 to read the tightening sequence.

- A. Obtain the content of existing tightening sequence.
- B. Check whether the tightening sequence has been set.

Handshake signal description:

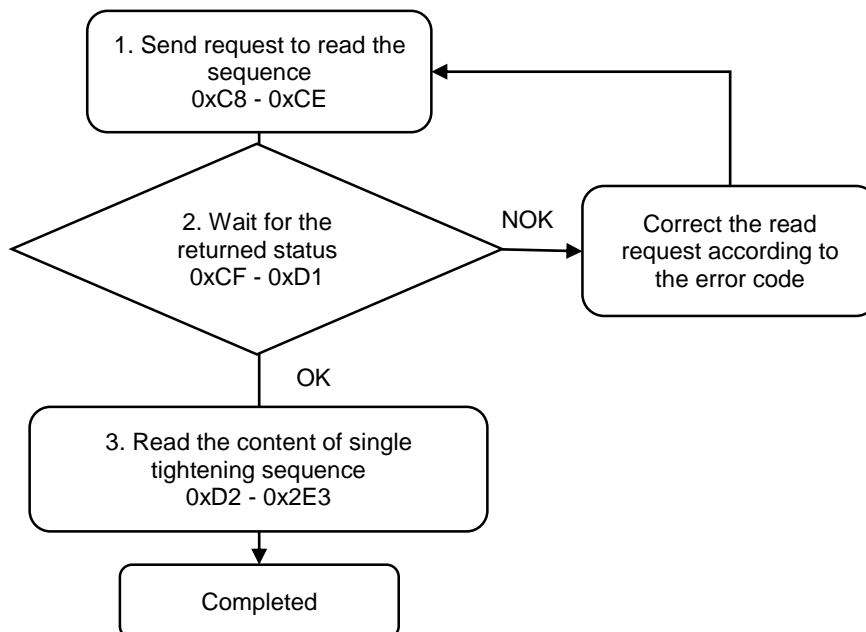

1. Fill in the read request to 0xC8 - 0xCE.

Modbus (Hex)	Write / Read request	Write
C8	Function code	250
C9	Version number	0
CA	Sequence ID	1 (1 to 500)
CB	Reserved	-
CC	Reserved	-
CD	Reserved	-
CE	Request to send command	1 (fill in lastly)

2. Check whether the reading is successful from the returned status in 0xCF - 0xD1.

Modbus (Hex)	Returned status	Description
CF	Function code	250
D0	Returned status	1: OK; 2: NOK
D1	Error code	Error code

If successful, the returned status (0xD0) is read as 1.

If failed, the returned status (0xD0) is read as 2. The error code is as follows:

Code	Error description	Description
1	Sequence ID	Exceeds the range of 1 to 500

3. Read the content of tightening sequence in 0xD2 - 0x2E3.

Modbus (Hex)	Function	Description
D2 - E5	Sequence title (20 words)	ASCII code
E6	General / Navigator mode	0: General mode 1: Navigator mode
E7 - EF	Reserved	-
F0	Tool ID for Set 1	0: Tool 1; 1: Tool 2
F1	Tool ID for Set 2	0: Tool 1; 1: Tool 2
F2	Tool ID for Set 3	0: Tool 1; 1: Tool 2
F3	Tool ID for Set 4	0: Tool 1; 1: Tool 2
F4	Tool ID for Set 5	0: Tool 1; 1: Tool 2
F5	Tool ID for Set 6	0: Tool 1; 1: Tool 2
F6	Tool ID for Set 7	0: Tool 1; 1: Tool 2
F7	Tool ID for Set 8	0: Tool 1; 1: Tool 2
F8	Tool ID for Set 9	0: Tool 1; 1: Tool 2
F9	Tool ID for Set 10	0: Tool 1; 1: Tool 2
FA	Tool ID for Set 11	0: Tool 1; 1: Tool 2
FB	Tool ID for Set 12	0: Tool 1; 1: Tool 2
FC	Tool ID for Set 13	0: Tool 1; 1: Tool 2
FD	Tool ID for Set 14	0: Tool 1; 1: Tool 2
FE	Tool ID for Set 15	0: Tool 1; 1: Tool 2
FF	Tool ID for Set 16	0: Tool 1; 1: Tool 2
100	Tool ID for Set 17	0: Tool 1; 1: Tool 2
101	Tool ID for Set 18	0: Tool 1; 1: Tool 2

A

Modbus (Hex)	Function	Description
102	Tool ID for Set 19	0: Tool 1; 1: Tool 2
103	Tool ID for Set 20	0: Tool 1; 1: Tool 2
104	Tool ID for Set 21	0: Tool 1; 1: Tool 2
105	Tool ID for Set 22	0: Tool 1; 1: Tool 2
106	Tool ID for Set 23	0: Tool 1; 1: Tool 2
107	Tool ID for Set 24	0: Tool 1; 1: Tool 2
108	Tool ID for Set 25	0: Tool 1; 1: Tool 2
109	Tool ID for Set 26	0: Tool 1; 1: Tool 2
10A	Tool ID for Set 27	0: Tool 1; 1: Tool 2
10B	Tool ID for Set 28	0: Tool 1; 1: Tool 2
10C	Tool ID for Set 29	0: Tool 1; 1: Tool 2
10D	Tool ID for Set 30	0: Tool 1; 1: Tool 2
10E	Tool ID for Set 31	0: Tool 1; 1: Tool 2
10F	Tool ID for Set 32	0: Tool 1; 1: Tool 2
110	Tool ID for Set 33	0: Tool 1; 1: Tool 2
111	Tool ID for Set 34	0: Tool 1; 1: Tool 2
112	Tool ID for Set 35	0: Tool 1; 1: Tool 2
113	Tool ID for Set 36	0: Tool 1; 1: Tool 2
114	Tool ID for Set 37	0: Tool 1; 1: Tool 2
115	Tool ID for Set 38	0: Tool 1; 1: Tool 2
116	Tool ID for Set 39	0: Tool 1; 1: Tool 2
117	Tool ID for Set 40	0: Tool 1; 1: Tool 2
118	Tool ID for Set 41	0: Tool 1; 1: Tool 2
119	Tool ID for Set 42	0: Tool 1; 1: Tool 2
11A	Tool ID for Set 43	0: Tool 1; 1: Tool 2
11B	Tool ID for Set 44	0: Tool 1; 1: Tool 2
11C	Tool ID for Set 45	0: Tool 1; 1: Tool 2
11D	Tool ID for Set 46	0: Tool 1; 1: Tool 2
11E	Tool ID for Set 47	0: Tool 1; 1: Tool 2
11F	Tool ID for Set 48	0: Tool 1; 1: Tool 2
120	Tool ID for Set 49	0: Tool 1; 1: Tool 2
121	Tool ID for Set 50	0: Tool 1; 1: Tool 2
122	Tool ID for Set 51	0: Tool 1; 1: Tool 2
123	Tool ID for Set 52	0: Tool 1; 1: Tool 2
124	Tool ID for Set 53	0: Tool 1; 1: Tool 2
125	Tool ID for Set 54	0: Tool 1; 1: Tool 2
126	Tool ID for Set 55	0: Tool 1; 1: Tool 2
127	Tool ID for Set 56	0: Tool 1; 1: Tool 2
128	Tool ID for Set 57	0: Tool 1; 1: Tool 2
129	Tool ID for Set 58	0: Tool 1; 1: Tool 2
12A	Tool ID for Set 59	0: Tool 1; 1: Tool 2
12B	Tool ID for Set 60	0: Tool 1; 1: Tool 2
12C	Tool ID for Set 61	0: Tool 1; 1: Tool 2

Modbus (Hex)	Function	Description
12D	Tool ID for Set 62	0: Tool 1; 1: Tool 2
12E	Tool ID for Set 63	0: Tool 1; 1: Tool 2
12F	Tool ID for Set 64	0: Tool 1; 1: Tool 2
130	Tool ID for Set 65	0: Tool 1; 1: Tool 2
131	Tool ID for Set 66	0: Tool 1; 1: Tool 2
132	Tool ID for Set 67	0: Tool 1; 1: Tool 2
133	Tool ID for Set 68	0: Tool 1; 1: Tool 2
134	Tool ID for Set 69	0: Tool 1; 1: Tool 2
135	Tool ID for Set 70	0: Tool 1; 1: Tool 2
136	Tool ID for Set 71	0: Tool 1; 1: Tool 2
137	Tool ID for Set 72	0: Tool 1; 1: Tool 2
138	Tool ID for Set 73	0: Tool 1; 1: Tool 2
139	Tool ID for Set 74	0: Tool 1; 1: Tool 2
13A	Tool ID for Set 75	0: Tool 1; 1: Tool 2
13B	Tool ID for Set 76	0: Tool 1; 1: Tool 2
13C	Tool ID for Set 77	0: Tool 1; 1: Tool 2
13D	Tool ID for Set 78	0: Tool 1; 1: Tool 2
13E	Tool ID for Set 79	0: Tool 1; 1: Tool 2
13F	Tool ID for Set 80	0: Tool 1; 1: Tool 2
140	Tool ID for Set 81	0: Tool 1; 1: Tool 2
141	Tool ID for Set 82	0: Tool 1; 1: Tool 2
142	Tool ID for Set 83	0: Tool 1; 1: Tool 2
143	Tool ID for Set 84	0: Tool 1; 1: Tool 2
144	Tool ID for Set 85	0: Tool 1; 1: Tool 2
145	Tool ID for Set 86	0: Tool 1; 1: Tool 2
146	Tool ID for Set 87	0: Tool 1; 1: Tool 2
147	Tool ID for Set 88	0: Tool 1; 1: Tool 2
148	Tool ID for Set 89	0: Tool 1; 1: Tool 2
149	Tool ID for Set 90	0: Tool 1; 1: Tool 2
14A	Tool ID for Set 91	0: Tool 1; 1: Tool 2
14B	Tool ID for Set 92	0: Tool 1; 1: Tool 2
14C	Tool ID for Set 93	0: Tool 1; 1: Tool 2
14D	Tool ID for Set 94	0: Tool 1; 1: Tool 2
14E	Tool ID for Set 95	0: Tool 1; 1: Tool 2
14F	Tool ID for Set 96	0: Tool 1; 1: Tool 2
150	Tool ID for Set 97	0: Tool 1; 1: Tool 2
151	Tool ID for Set 98	0: Tool 1; 1: Tool 2
152	Tool ID for Set 99	0: Tool 1; 1: Tool 2
153	Tool ID for Set 100	0: Tool 1; 1: Tool 2
154	Parameter ID for Set 1	1 to 500
155	Parameter ID for Set 2	1 to 500
156	Parameter ID for Set 3	1 to 500

A

Modbus (Hex)	Function	Description
157	Parameter ID for Set 4	1 to 500
158	Parameter ID for Set 5	1 to 500
159	Parameter ID for Set 6	1 to 500
15A	Parameter ID for Set 7	1 to 500
15B	Parameter ID for Set 8	1 to 500
15C	Parameter ID for Set 9	1 to 500
15D	Parameter ID for Set 10	1 to 500
15E	Parameter ID for Set 11	1 to 500
15F	Parameter ID for Set 12	1 to 500
160	Parameter ID for Set 13	1 to 500
161	Parameter ID for Set 14	1 to 500
162	Parameter ID for Set 15	1 to 500
163	Parameter ID for Set 16	1 to 500
164	Parameter ID for Set 17	1 to 500
165	Parameter ID for Set 18	1 to 500
166	Parameter ID for Set 19	1 to 500
167	Parameter ID for Set 20	1 to 500
168	Parameter ID for Set 21	1 to 500
169	Parameter ID for Set 22	1 to 500
16A	Parameter ID for Set 23	1 to 500
16B	Parameter ID for Set 24	1 to 500
16C	Parameter ID for Set 25	1 to 500
16D	Parameter ID for Set 26	1 to 500
16E	Parameter ID for Set 27	1 to 500
16F	Parameter ID for Set 28	1 to 500
170	Parameter ID for Set 29	1 to 500
171	Parameter ID for Set 30	1 to 500
172	Parameter ID for Set 31	1 to 500
173	Parameter ID for Set 32	1 to 500
174	Parameter ID for Set 33	1 to 500
175	Parameter ID for Set 34	1 to 500
176	Parameter ID for Set 35	1 to 500
177	Parameter ID for Set 36	1 to 500
178	Parameter ID for Set 37	1 to 500
179	Parameter ID for Set 38	1 to 500
17A	Parameter ID for Set 39	1 to 500
17B	Parameter ID for Set 40	1 to 500
17C	Parameter ID for Set 41	1 to 500
17D	Parameter ID for Set 42	1 to 500
17E	Parameter ID for Set 43	1 to 500
17F	Parameter ID for Set 44	1 to 500
180	Parameter ID for Set 45	1 to 500
181	Parameter ID for Set 46	1 to 500

Modbus (Hex)	Function	Description
182	Parameter ID for Set 47	1 to 500
183	Parameter ID for Set 48	1 to 500
184	Parameter ID for Set 49	1 to 500
185	Parameter ID for Set 50	1 to 500
186	Parameter ID for Set 51	1 to 500
187	Parameter ID for Set 52	1 to 500
188	Parameter ID for Set 53	1 to 500
189	Parameter ID for Set 54	1 to 500
18A	Parameter ID for Set 55	1 to 500
18B	Parameter ID for Set 56	1 to 500
18C	Parameter ID for Set 57	1 to 500
18D	Parameter ID for Set 58	1 to 500
18E	Parameter ID for Set 59	1 to 500
18F	Parameter ID for Set 60	1 to 500
190	Parameter ID for Set 61	1 to 500
191	Parameter ID for Set 62	1 to 500
192	Parameter ID for Set 63	1 to 500
193	Parameter ID for Set 64	1 to 500
194	Parameter ID for Set 65	1 to 500
195	Parameter ID for Set 66	1 to 500
196	Parameter ID for Set 67	1 to 500
197	Parameter ID for Set 68	1 to 500
198	Parameter ID for Set 69	1 to 500
199	Parameter ID for Set 70	1 to 500
19A	Parameter ID for Set 71	1 to 500
19B	Parameter ID for Set 72	1 to 500
19C	Parameter ID for Set 73	1 to 500
19D	Parameter ID for Set 74	1 to 500
19E	Parameter ID for Set 75	1 to 500
19F	Parameter ID for Set 76	1 to 500
1A0	Parameter ID for Set 77	1 to 500
1A1	Parameter ID for Set 78	1 to 500
1A2	Parameter ID for Set 79	1 to 500
1A3	Parameter ID for Set 80	1 to 500
1A4	Parameter ID for Set 81	1 to 500
1A5	Parameter ID for Set 82	1 to 500
1A6	Parameter ID for Set 83	1 to 500
1A7	Parameter ID for Set 84	1 to 500
1A8	Parameter ID for Set 85	1 to 500
1A9	Parameter ID for Set 86	1 to 500
1AA	Parameter ID for Set 87	1 to 500
1AB	Parameter ID for Set 88	1 to 500

A

Modbus (Hex)	Function	Description
1AC	Parameter ID for Set 89	1 to 500
1AD	Parameter ID for Set 90	1 to 500
1AE	Parameter ID for Set 91	1 to 500
1AF	Parameter ID for Set 92	1 to 500
1B0	Parameter ID for Set 93	1 to 500
1B1	Parameter ID for Set 94	1 to 500
1B2	Parameter ID for Set 95	1 to 500
1B3	Parameter ID for Set 96	1 to 500
1B4	Parameter ID for Set 97	1 to 500
1B5	Parameter ID for Set 98	1 to 500
1B6	Parameter ID for Set 99	1 to 500
1B7	Parameter ID for Set 100	1 to 500
1B8	Screw quantity for Set 1 (L)	1 to 999999
1B9	Screw quantity for Set 1 (H)	
1BA	Screw quantity for Set 2 (L)	1 to 999999
1BB	Screw quantity for Set 2 (H)	
1BC	Screw quantity for Set 3 (L)	1 to 999999
1BD	Screw quantity for Set 3 (H)	
1BE	Screw quantity for Set 4 (L)	1 to 999999
1BF	Screw quantity for Set 4 (H)	
1C0	Screw quantity for Set 5 (L)	1 to 999999
1C1	Screw quantity for Set 5 (H)	
1C2	Screw quantity for Set 6 (L)	1 to 999999
1C3	Screw quantity for Set 6 (H)	
1C4	Screw quantity for Set 7 (L)	1 to 999999
1C5	Screw quantity for Set 7 (H)	
1C6	Screw quantity for Set 8 (L)	1 to 999999
1C7	Screw quantity for Set 8 (H)	
1C8	Screw quantity for Set 9 (L)	1 to 999999
1C9	Screw quantity for Set 9 (H)	
1CA	Screw quantity for Set 10 (L)	1 to 999999
1CB	Screw quantity for Set 10 (H)	
1CC	Screw quantity for Set 11 (L)	1 to 999999
1CD	Screw quantity for Set 11 (H)	
1CE	Screw quantity for Set 12 (L)	1 to 999999
1CF	Screw quantity for Set 12 (H)	
1D0	Screw quantity for Set 13 (L)	1 to 999999
1D1	Screw quantity for Set 13 (H)	
1D2	Screw quantity for Set 14 (L)	1 to 999999
1D3	Screw quantity for Set 14 (H)	
1D4	Screw quantity for Set 15 (L)	1 to 999999
1D5	Screw quantity for Set 15 (H)	

A

Modbus (Hex)	Function	Description
1D6	Screw quantity for Set 16 (L)	1 to 999999
1D7	Screw quantity for Set 16 (H)	
1D8	Screw quantity for Set 17 (L)	1 to 999999
1D9	Screw quantity for Set 17 (H)	
1DA	Screw quantity for Set 18 (L)	1 to 999999
1DB	Screw quantity for Set 18 (H)	
1DC	Screw quantity for Set 19 (L)	1 to 999999
1DD	Screw quantity for Set 19 (H)	
1DE	Screw quantity for Set 20 (L)	1 to 999999
1DF	Screw quantity for Set 20 (H)	
1E0	Screw quantity for Set 21 (L)	1 to 999999
1E1	Screw quantity for Set 21 (H)	
1E2	Screw quantity for Set 22 (L)	1 to 999999
1E3	Screw quantity for Set 22 (H)	
1E4	Screw quantity for Set 23 (L)	1 to 999999
1E5	Screw quantity for Set 23 (H)	
1E6	Screw quantity for Set 24 (L)	1 to 999999
1E7	Screw quantity for Set 24 (H)	
1E8	Screw quantity for Set 25 (L)	1 to 999999
1E9	Screw quantity for Set 25 (H)	
1EA	Screw quantity for Set 26 (L)	1 to 999999
1EB	Screw quantity for Set 26 (H)	
1EC	Screw quantity for Set 27 (L)	1 to 999999
1ED	Screw quantity for Set 27 (H)	
1EE	Screw quantity for Set 28 (L)	1 to 999999
1EF	Screw quantity for Set 28 (H)	
1F0	Screw quantity for Set 29 (L)	1 to 999999
1F1	Screw quantity for Set 29 (H)	
1F2	Screw quantity for Set 30 (L)	1 to 999999
1F3	Screw quantity for Set 30 (H)	
1F4	Screw quantity for Set 31 (L)	1 to 999999
1F5	Screw quantity for Set 31 (H)	
1F6	Screw quantity for Set 32 (L)	1 to 999999
1F7	Screw quantity for Set 32 (H)	
1F8	Screw quantity for Set 33 (L)	1 to 999999
1F9	Screw quantity for Set 33 (H)	
1FA	Screw quantity for Set 34 (L)	1 to 999999
1FB	Screw quantity for Set 34 (H)	
1FC	Screw quantity for Set 35 (L)	1 to 999999
1FD	Screw quantity for Set 35 (H)	
1FE	Screw quantity for Set 36 (L)	1 to 999999
1FF	Screw quantity for Set 36 (H)	

A

Modbus (Hex)	Function	Description
200	Screw quantity for Set 37 (L)	1 to 999999
201	Screw quantity for Set 37 (H)	
202	Screw quantity for Set 38 (L)	1 to 999999
203	Screw quantity for Set 38 (H)	
204	Screw quantity for Set 39 (L)	1 to 999999
205	Screw quantity for Set 39 (H)	
206	Screw quantity for Set 40 (L)	1 to 999999
207	Screw quantity for Set 40 (H)	
208	Screw quantity for Set 41 (L)	1 to 999999
209	Screw quantity for Set 41 (H)	
20A	Screw quantity for Set 42 (L)	1 to 999999
20B	Screw quantity for Set 42 (H)	
20C	Screw quantity for Set 43 (L)	1 to 999999
20D	Screw quantity for Set 43 (H)	
20E	Screw quantity for Set 44 (L)	1 to 999999
20F	Screw quantity for Set 44 (H)	
210	Screw quantity for Set 45 (L)	1 to 999999
211	Screw quantity for Set 45 (H)	
212	Screw quantity for Set 46 (L)	1 to 999999
213	Screw quantity for Set 46 (H)	
214	Screw quantity for Set 47 (L)	1 to 999999
215	Screw quantity for Set 47 (H)	
216	Screw quantity for Set 48 (L)	1 to 999999
217	Screw quantity for Set 48 (H)	
218	Screw quantity for Set 49 (L)	1 to 999999
219	Screw quantity for Set 49 (H)	
21A	Screw quantity for Set 50 (L)	1 to 999999
21B	Screw quantity for Set 50 (H)	
21C	Screw quantity for Set 51 (L)	1 to 999999
21D	Screw quantity for Set 51 (H)	
21E	Screw quantity for Set 52 (L)	1 to 999999
21F	Screw quantity for Set 52 (H)	
220	Screw quantity for Set 53 (L)	1 to 999999
221	Screw quantity for Set 53 (H)	
222	Screw quantity for Set 54 (L)	1 to 999999
223	Screw quantity for Set 54 (H)	
224	Screw quantity for Set 55 (L)	1 to 999999
225	Screw quantity for Set 55 (H)	
226	Screw quantity for Set 56 (L)	1 to 999999
227	Screw quantity for Set 56 (H)	
228	Screw quantity for Set 57 (L)	1 to 999999
229	Screw quantity for Set 57 (H)	

Modbus (Hex)	Function	Description
22A	Screw quantity for Set 58 (L)	1 to 999999
22B	Screw quantity for Set 58 (H)	
22C	Screw quantity for Set 59 (L)	1 to 999999
22D	Screw quantity for Set 59 (H)	
22E	Screw quantity for Set 60 (L)	1 to 999999
22F	Screw quantity for Set 60 (H)	
230	Screw quantity for Set 61 (L)	1 to 999999
231	Screw quantity for Set 61 (H)	
232	Screw quantity for Set 62 (L)	1 to 999999
233	Screw quantity for Set 62 (H)	
234	Screw quantity for Set 63 (L)	1 to 999999
235	Screw quantity for Set 63 (H)	
236	Screw quantity for Set 64 (L)	1 to 999999
237	Screw quantity for Set 64 (H)	
238	Screw quantity for Set 65 (L)	1 to 999999
239	Screw quantity for Set 65 (H)	
23A	Screw quantity for Set 66 (L)	1 to 999999
23B	Screw quantity for Set 66 (H)	
23C	Screw quantity for Set 67 (L)	1 to 999999
23D	Screw quantity for Set 67 (H)	
23E	Screw quantity for Set 68 (L)	1 to 999999
23F	Screw quantity for Set 68 (H)	
240	Screw quantity for Set 69 (L)	1 to 999999
241	Screw quantity for Set 69 (H)	
242	Screw quantity for Set 70 (L)	1 to 999999
243	Screw quantity for Set 70 (H)	
244	Screw quantity for Set 71 (L)	1 to 999999
245	Screw quantity for Set 71 (H)	
246	Screw quantity for Set 72 (L)	1 to 999999
247	Screw quantity for Set 72 (H)	
248	Screw quantity for Set 73 (L)	1 to 999999
249	Screw quantity for Set 73 (H)	
24A	Screw quantity for Set 74 (L)	1 to 999999
24B	Screw quantity for Set 74 (H)	
24C	Screw quantity for Set 75 (L)	1 to 999999
24D	Screw quantity for Set 75 (H)	
24E	Screw quantity for Set 76 (L)	1 to 999999
24F	Screw quantity for Set 76 (H)	
250	Screw quantity for Set 77 (L)	1 to 999999
251	Screw quantity for Set 77 (H)	
252	Screw quantity for Set 78 (L)	1 to 999999
253	Screw quantity for Set 78 (H)	

A

Modbus (Hex)	Function	Description
254	Screw quantity for Set 79 (L)	1 to 999999
255	Screw quantity for Set 79 (H)	
256	Screw quantity for Set 80 (L)	1 to 999999
257	Screw quantity for Set 80 (H)	
258	Screw quantity for Set 81 (L)	1 to 999999
259	Screw quantity for Set 81 (H)	
25A	Screw quantity for Set 82 (L)	1 to 999999
25B	Screw quantity for Set 82 (H)	
25C	Screw quantity for Set 83 (L)	1 to 999999
25D	Screw quantity for Set 83 (H)	
25E	Screw quantity for Set 84 (L)	1 to 999999
25F	Screw quantity for Set 84 (H)	
260	Screw quantity for Set 85 (L)	1 to 999999
261	Screw quantity for Set 85 (H)	
262	Screw quantity for Set 86 (L)	1 to 999999
263	Screw quantity for Set 86 (H)	
264	Screw quantity for Set 87 (L)	1 to 999999
265	Screw quantity for Set 87 (H)	
266	Screw quantity for Set 88 (L)	1 to 999999
267	Screw quantity for Set 88 (H)	
268	Screw quantity for Set 89 (L)	1 to 999999
269	Screw quantity for Set 89 (H)	
26A	Screw quantity for Set 90 (L)	1 to 999999
26B	Screw quantity for Set 90 (H)	
26C	Screw quantity for Set 91 (L)	1 to 999999
26D	Screw quantity for Set 91 (H)	
26E	Screw quantity for Set 92 (L)	1 to 999999
26F	Screw quantity for Set 92 (H)	
270	Screw quantity for Set 93 (L)	1 to 999999
271	Screw quantity for Set 93 (H)	
272	Screw quantity for Set 94 (L)	1 to 999999
273	Screw quantity for Set 94 (H)	
274	Screw quantity for Set 95 (L)	1 to 999999
275	Screw quantity for Set 95 (H)	
276	Screw quantity for Set 96 (L)	1 to 999999
277	Screw quantity for Set 96 (H)	
278	Screw quantity for Set 97 (L)	1 to 999999
279	Screw quantity for Set 97 (H)	
27A	Screw quantity for Set 98 (L)	1 to 999999
27B	Screw quantity for Set 98 (H)	
27C	Screw quantity for Set 99 (L)	1 to 999999
27D	Screw quantity for Set 99 (H)	

A

Modbus (Hex)	Function	Description
27E	Screw quantity for Set 100 (L)	1 to 999999
27F	Screw quantity for Set 100 (H)	
280	Bit ID for Set 1	0 to 255
281	Bit ID for Set 2	0 to 255
282	Bit ID for Set 3	0 to 255
283	Bit ID for Set 4	0 to 255
284	Bit ID for Set 5	0 to 255
285	Bit ID for Set 6	0 to 255
286	Bit ID for Set 7	0 to 255
287	Bit ID for Set 8	0 to 255
288	Bit ID for Set 9	0 to 255
289	Bit ID for Set 10	0 to 255
28A	Bit ID for Set 11	0 to 255
28B	Bit ID for Set 12	0 to 255
28C	Bit ID for Set 13	0 to 255
28D	Bit ID for Set 14	0 to 255
28E	Bit ID for Set 15	0 to 255
28F	Bit ID for Set 16	0 to 255
290	Bit ID for Set 17	0 to 255
291	Bit ID for Set 18	0 to 255
292	Bit ID for Set 19	0 to 255
293	Bit ID for Set 20	0 to 255
294	Bit ID for Set 21	0 to 255
295	Bit ID for Set 22	0 to 255
296	Bit ID for Set 23	0 to 255
297	Bit ID for Set 24	0 to 255
298	Bit ID for Set 25	0 to 255
299	Bit ID for Set 26	0 to 255
29A	Bit ID for Set 27	0 to 255
29B	Bit ID for Set 28	0 to 255
29C	Bit ID for Set 29	0 to 255
29D	Bit ID for Set 30	0 to 255
29E	Bit ID for Set 31	0 to 255
29F	Bit ID for Set 32	0 to 255
2A0	Bit ID for Set 33	0 to 255
2A1	Bit ID for Set 34	0 to 255
2A2	Bit ID for Set 35	0 to 255
2A3	Bit ID for Set 36	0 to 255
2A4	Bit ID for Set 37	0 to 255
2A5	Bit ID for Set 38	0 to 255
2A6	Bit ID for Set 39	0 to 255
2A7	Bit ID for Set 40	0 to 255

A

Modbus (Hex)	Function	Description
2A8	Bit ID for Set 41	0 to 255
2A9	Bit ID for Set 42	0 to 255
2AA	Bit ID for Set 43	0 to 255
2AB	Bit ID for Set 44	0 to 255
2AC	Bit ID for Set 45	0 to 255
2AD	Bit ID for Set 46	0 to 255
2AE	Bit ID for Set 47	0 to 255
2AF	Bit ID for Set 48	0 to 255
2B0	Bit ID for Set 49	0 to 255
2B1	Bit ID for Set 50	0 to 255
2B2	Bit ID for Set 51	0 to 255
2B3	Bit ID for Set 52	0 to 255
2B4	Bit ID for Set 53	0 to 255
2B5	Bit ID for Set 54	0 to 255
2B6	Bit ID for Set 55	0 to 255
2B7	Bit ID for Set 56	0 to 255
2B8	Bit ID for Set 57	0 to 255
2B9	Bit ID for Set 58	0 to 255
2BA	Bit ID for Set 59	0 to 255
2BB	Bit ID for Set 60	0 to 255
2BC	Bit ID for Set 61	0 to 255
2BD	Bit ID for Set 62	0 to 255
2BE	Bit ID for Set 63	0 to 255
2BF	Bit ID for Set 64	0 to 255
2C0	Bit ID for Set 65	0 to 255
2C1	Bit ID for Set 66	0 to 255
2C2	Bit ID for Set 67	0 to 255
2C3	Bit ID for Set 68	0 to 255
2C4	Bit ID for Set 69	0 to 255
2C5	Bit ID for Set 70	0 to 255
2C6	Bit ID for Set 71	0 to 255
2C7	Bit ID for Set 72	0 to 255
2C8	Bit ID for Set 73	0 to 255
2C9	Bit ID for Set 74	0 to 255
2CA	Bit ID for Set 75	0 to 255
2CB	Bit ID for Set 76	0 to 255
2CC	Bit ID for Set 77	0 to 255
2CD	Bit ID for Set 78	0 to 255
2CE	Bit ID for Set 79	0 to 255
2CF	Bit ID for Set 80	0 to 255
2D0	Bit ID for Set 81	0 to 255
2D1	Bit ID for Set 82	0 to 255
2D2	Bit ID for Set 83	0 to 255

Modbus (Hex)	Function	Description
2D3	Bit ID for Set 84	0 to 255
2D4	Bit ID for Set 85	0 to 255
2D5	Bit ID for Set 86	0 to 255
2D6	Bit ID for Set 87	0 to 255
2D7	Bit ID for Set 88	0 to 255
2D8	Bit ID for Set 89	0 to 255
2D9	Bit ID for Set 90	0 to 255
2DA	Bit ID for Set 91	0 to 255
2DB	Bit ID for Set 92	0 to 255
2DC	Bit ID for Set 93	0 to 255
2DD	Bit ID for Set 94	0 to 255
2DE	Bit ID for Set 95	0 to 255
2DF	Bit ID for Set 96	0 to 255
2E0	Bit ID for Set 97	0 to 255
2E1	Bit ID for Set 98	0 to 255
2E2	Bit ID for Set 99	0 to 255
2E3	Bit ID for Set 100	0 to 255

A

A.3.3 Sources operations

Sources			
Function code	Function name	Function code	Function name
#300	Write the operation mode and switching method of Sources	#350	Read the operation mode and switching method of Sources
#301	Write the contents of single source settings	#351	Read the contents of single source settings

#300 Write the operation mode and switching method of Sources

Content description:

Use function code #300 to switch the operation mode and switching method of the controller.

Handshake signal description:

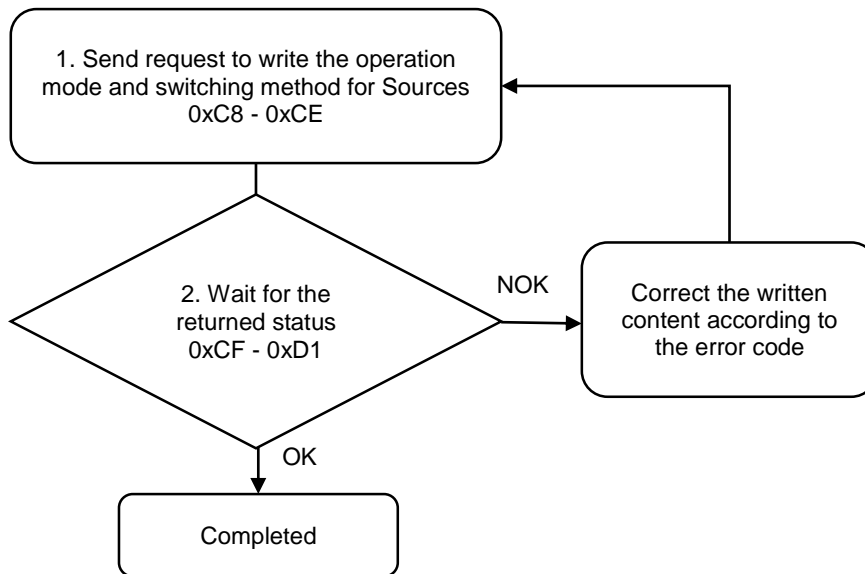

1. Fill in the write request to 0xC8 - 0xCE.

Modbus (Hex)	Write / Read request	Write
C8	Function code	300
C9	Version number	0
CA	Tool 1 / Tool 2	0: Tool 1; 1: Tool 2
CB	Operation mode	0: single-tool operation 1: dual-tool alternation 2: dual-tool synchronization
CC	Switching method	0: manual 1: screw bit selector 2: barcode scanner
CD	Reserved	-
CE	Request to send command	1 (fill in lastly)

2. Then check whether the writing is successful from the returned status in 0xCF - 0xD1.

Modbus (Hex)	Returned status	Description
CF	Function code	300
D0	Returned status	1: OK; 2: NOK
D1	Error code	Error code

If successful, the returned status (0xD0) is read as 1, and the switching method is switched to the corresponding mode.

If failed, the returned status (0xD1) is read as 2. The error codes are as follows:

Code	Error description	Description
1	Operation mode	Exceeds the range of 0 to 2
2	Switching method	Exceeds the range of 0 to 2
3	Tool 1 / Tool 2	Must be 0 or 1
4	Cannot use dual-tool alternation or dual-tool synchronization when only one tool is activated	-
5	Cannot use the screw bit selector mode under dual-tool alternation	-

#301 Write the contents of single source settings

Content description:

Use function code #301 to set the tightening source.

- A. Add settings for single tightening source.
- B. Modify settings for an existing tightening source. First, read the settings of single source with function code #351. After modifying the settings, write the settings of single source with function code #301.

Handshake signal description:

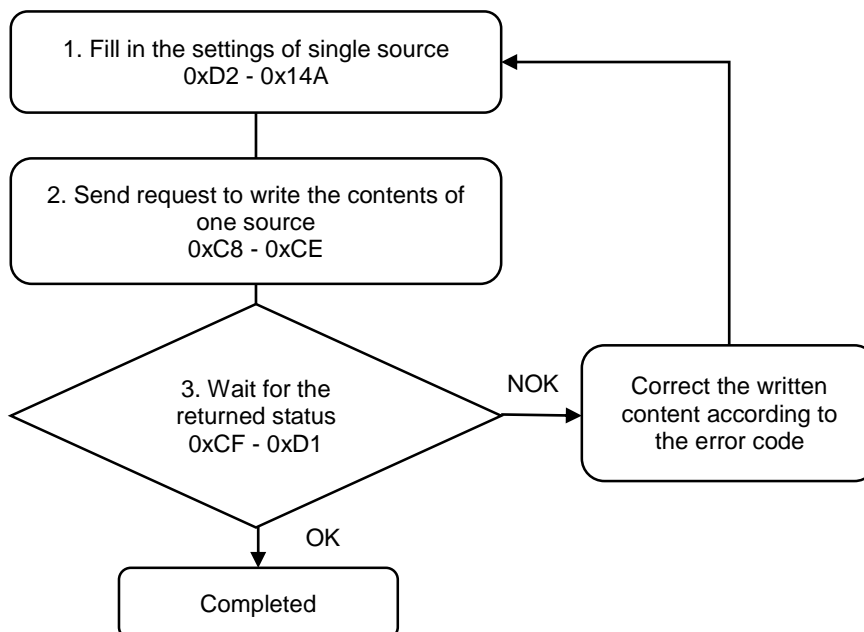

A

1. Fill in the settings of single source to 0xD2 - 0x14A.

Modbus (Hex)	Function	Description
D2 - 135	Corresponding barcode string (100 words)	ASCII code; only applicable when the switching mode is Barcode Scanner
136	Parameter / Sequence set for the switching method	0: parameter mode 1: sequence mode
137	Sequence / Parameter ID of the switching method	1 to 500
138	Total screw quantity (L)	1 to 999999
139	Total screw quantity (H)	
13A	Bit ID	0 to 255
13B	Advanced settings (L)	BIT0: loosening prohibited after tightening OK BIT1: loosening prohibited after tightening NOK BIT2: max. count for single screw NOK tightening BIT3: max. count for single screw NOK loosening BIT4: go to next step after tightening NOK BIT5: go to previous step after loosening OK BIT6: prohibit tool operation when scanner string is null
13C	Advanced settings (H)	BIT7: clear scanner string when screw Qty. reached BIT8: prohibit scanning when screw Qty. not reached BIT9: max. operation time BIT10: reset Qty. when screw Qty. reached BIT11: enable reminder when tightening signal ends too early
13D	Single screw tightening NOK count (L)	1 to 999999
13E	Single screw tightening NOK count (H)	
13F	Single screw loosening NOK count (L)	1 to 999999
140	Single screw loosening NOK count (H)	
141	Reserved	-
142	Reserved	-
143	Reserved	-
144	Reserved	-
145	Max. operation time (L)	1 to 9999999
146	Max. operation time (H)	
147	The parameters to be used under dual-tool alternation mode	0: use parameters of Tool 1 1: use parameters of Tool 2
148	Torque unit	0: Nm; 1: kgf-cm 2: lbf-ft; 3: lbf-in
149	Start condition for Tool 1	0: push start; 1: DI/DO; 2: lever start 3: push start or lever start 4: push start and lever start
14A	Start condition for Tool 2	0: push start; 1: DI/DO; 2: lever start 3: push start or lever start 4: push start and lever start

2. Fill in the write request to 0xC8 - 0xCE.

Modbus (Hex)	Write / Read request	Write
C8	Function code	301
C9	Version number	0
CA	Tool 1 / Tool 2	0: Tool 1; 1: Tool 2
CB	Switching method ID	Manual: 1 Screw bit selector: 1 to 255 Barcode scanner: 1 to 500
CC	Reserved	-
CD	Reserved	-
CE	Request to send command	1 (fill in lastly)

3. Then check whether the writing is successful from the returned status in 0xCF - 0xD1.

Modbus (Hex)	Returned status	Description
CF	Function code	301
D0	Returned status	1: OK; 2: NOK
D1	Error code	Error code

If successful, the returned status (0xD0) is read as 1.

If failed, the returned status (0xD1) is read as 2. The error codes are as follows:

Code	Error description	Description
1	Switching method ID	Exceeds the range of 1 to 500
2	Tool 1 / Tool 2	Must be 0 or 1
10	Parameters / Sequence mode	Must be 0 or 1
11	Specify parameters / sequence ID	Exceeds the range of 1 to 500
12	Total screw quantity	Exceeds the range of 1 to 999999
13	Bit ID	Exceeds the range of 0 to 255
20	Single screw tightening NOK count	Exceeds the range of 1 to 999999
21	Single screw loosening NOK count	Exceeds the range of 1 to 999999
40	Max. operation time	Exceeds the range of 1 to 9999999
50	Parameter error	Cannot select the parameter mode under dual-tool alternation
51	Sequence error	Must select the sequence of mixed mode (Tool 1 and Tool 2 are used alternatively) under dual-tool alternation
100	The title string is null	-
101	Title already exists	-

A

#350 Read the operation mode and switching method of Sources

Content description:

Use function code #350 to read the current operation mode and switching method of the controller.

Handshake signal description:

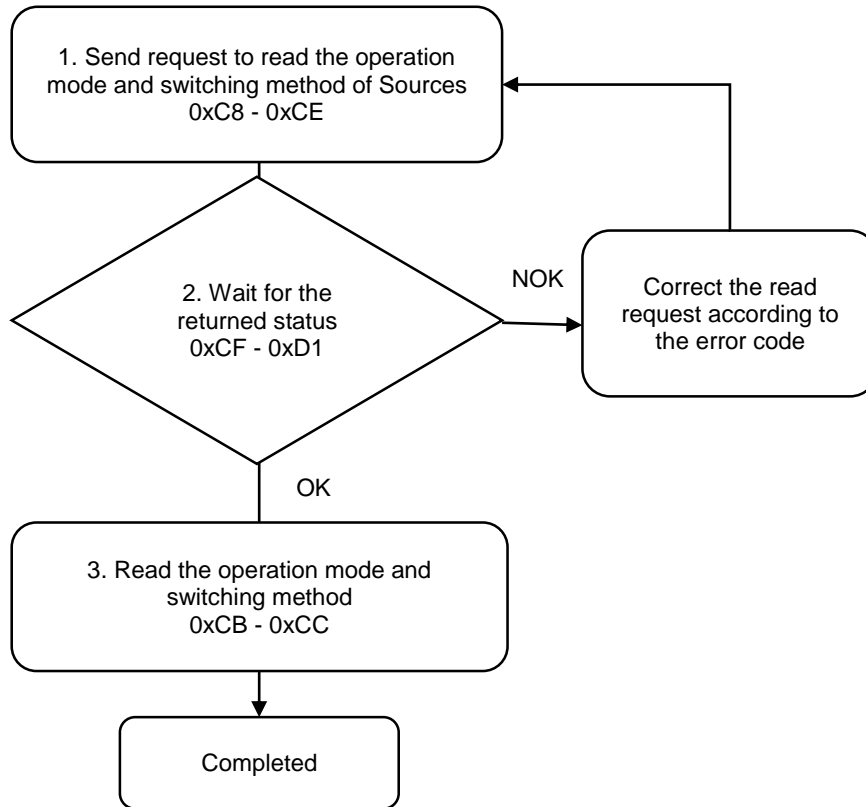

1. Fill in the read request to 0xC8 - 0xCE.

Modbus (Hex)	Write / Read request	Write
C8	Function code	350
C9	Version number	0
CA	Tool 1 / Tool 2	0: Tool 1; 1: Tool 2
CB	Reserved	-
CC	Reserved	-
CD	Reserved	-
CE	Request to send command	1 (fill in lastly)

2. Check whether the reading is successful from the returned status in 0xCF - 0xD1.

Modbus (Hex)	Returned status	Description
CF	Function code	350
D0	Returned status	1: OK; 2: NOK
D1	Error code	Error code

If successful, the returned status (0xD0) is read as 1.

A

If failed, the returned status (0xD0) is read as 2. The error code is as follows:

Code	Error description	Description
1	Tool 1 / Tool 2	Must be 0 or 1

3. Obtain the operation mode and switching method from 0xCB - 0xCC.

Modbus (Hex)	Write / Read request	Read
CB	Operation mode	0: single-tool operation 1: dual-tool alternation 2: dual-tool synchronization
CC	Switching method	0: manual 1: screw bit selector 2: barcode scanner

A

#351 Read the contents of single source settings

Content description:

Use function code #351 to read the settings of a single tightening source.

- A. Obtain the content of an existing tightening source.
- B. Check whether the tightening source has been set.

Handshake signal description:

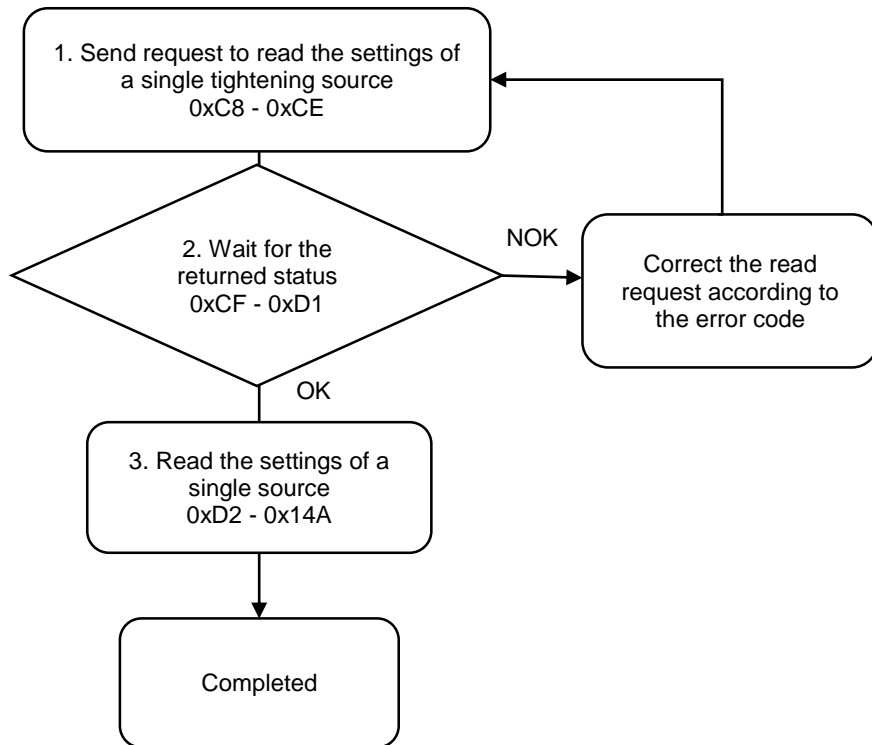

1. Fill in the read request to 0xC8 - 0xCE.

Modbus (Hex)	Write / Read request	Write
C8	Function code	351
C9	Version number	0
CA	Tool 1 / Tool 2	0: Tool 1; 1: Tool 2
CB	Switching method ID	Manual: 1 Screw bit selector: 1 to 255 Barcode scanner: 1 to 500
CC	Reserved	-
CD	Reserved	-
CE	Request to send command	1 (fill in lastly)

2. Check whether the reading is successful from the returned status in 0xCF - 0xD1.

Modbus (Hex)	Returned status	Description
CF	Function code	351
D0	Returned status	1: OK; 2: NOK
D1	Error code	Error code

If successful, the returned status (0xD0) is read as 1.

If failed, the returned status (0xD0) is read as 2. The error codes are as follows:

Code	Error description	Description
1	Switching method ID	Exceeds the range of 1 to 500
2	Tool 1 / Tool 2	Must be 0 or 1

3. Read the settings of single source in 0xD2 - 0x14A.

Modbus (Hex)	Function	Description
D2 - 135	Corresponding barcode string (100 words)	ASCII code; only applicable when the switching mode is Barcode Scanner
136	Parameter / Sequence set for the switching method	0: parameter mode 1: sequence mode
137	Sequence / Parameter ID of the switching method	1 to 500
138	Total screw quantity (L)	1 to 999999
139	Total screw quantity (H)	
13A	Bit ID	0 to 255
13B	Advanced settings (L)	BIT0: loosening prohibited after tightening OK BIT1: loosening prohibited after tightening NOK BIT2: max. count for single screw NOK tightening BIT3: max. count for single screw NOK loosening BIT4: go to next step after tightening NOK BIT5: go to previous step after loosening OK BIT6: prohibit tool operation when scanner string is null
13C	Advanced settings (H)	BIT7: clear scanner string when screw Qty. reached BIT8: prohibit scanning when screw Qty. not reached BIT9: max. operation time BIT10: reset Qty. when screw Qty. reached BIT11: enable reminder when tightening signal ends too early
13D	Single screw tightening NOK count (L)	1 to 999999
13E	Single screw tightening NOK count (H)	
13F	Single screw loosening NOK count (L)	1 to 999999
140	Single screw loosening NOK count (H)	
141	Reserved	-
142	Reserved	-
143	Reserved	-
144	Reserved	-
145	Max. operation time (L)	1 to 9999999
146	Max. operation time (H)	
147	The parameters to be used under dual-tool alternation mode	0: use parameters of Tool 1 1: use parameters of Tool 2
148	Torque unit	0: Nm; 1: kgf-cm 2: lbf-ft; 3: lbf-in
149	Start condition for Tool 1	0: push start; 1: DI/DO; 2: lever start 3: push start or lever start 4: push start and lever start
14A	Start condition for Tool 2	0: push start; 1: DI/DO; 2: lever start 3: push start or lever start 4: push start and lever start

A

A.3.4 Results operations

Results			
Function code	Function name	Function code	Function name
#400	Write the switching method of Sources	#450	Read the switching method of Sources
#401	Write the scanner string	#451	Read the scanner string
#402	Write to clear all errors	#452	Read the scanner advanced settings
#403	Write to reset the operation progress	-	-
#404	Write to execute the previous step	-	-
#405	Write to execute the next step	-	-
#406	Write to restrict tightening operation	-	-
#407	Write to restrict loosening operation	-	-
#408	Write the scanner advanced settings	-	-

#400 Write the switching method of Sources

Content description:

Use function code #400 to switch the current switching method ID.

Handshake signal description:

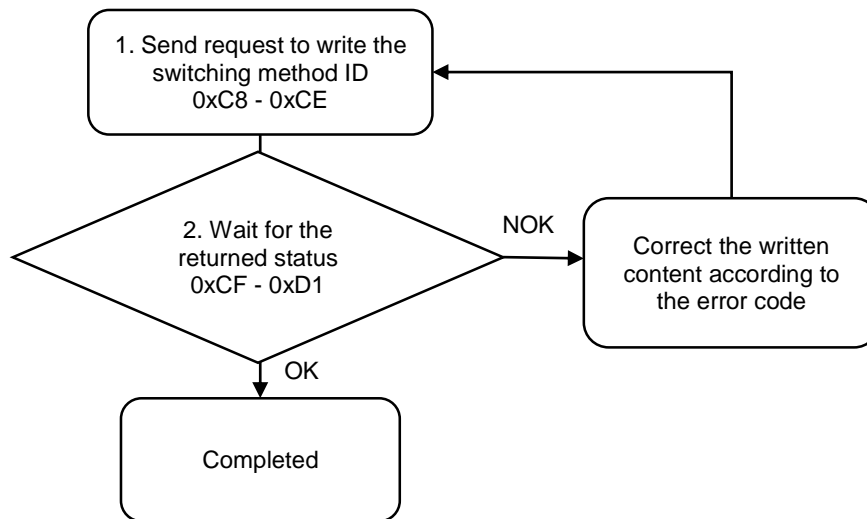

1. Fill in the write request to 0xC8 - 0xCE.

Modbus (Hex)	Write / Read request	Write
C8	Function code	400
C9	Version number	0
CA	Tool 1 / Tool 2	0: Tool 1; 1: Tool 2
CB	Switching method	Manual: 1 Screw bit selector: 1 to 255 Barcode scanner: 1 to 500
CC	Reserved	-
CD	Reserved	-
CE	Request to send command	1 (fill in lastly)

A

2. Then check whether the writing is successful from the returned status in 0xCF - 0xD1.

Modbus (Hex)	Returned status	Description
CF	Function code	400
D0	Returned status	1: OK; 2: NOK
D1	Error code	Error code

If successful, the returned status (0xD0) is read as 1, and the switching method is switched to the corresponding mode.

If failed, the returned status (0xD1) is read as 2. The error codes are as follows:

Code	Error description	Description
1	Tool 1 / Tool 2	Must be 0 or 1
2	Switching method ID	Manual: exceeds 1 Screw bit selector: exceeds the range of 1 to 255 Barcode scanner: exceeds the range of 1 to 500

#401 Write the scanner string

Content description:

Use function code #401 to input the scanner string.

- A. Input the scanner string to the controller.
- B. If the switching method is set as Barcode Scanner, when you input the scanner string, the content of the string is immediately matched and switched to the corresponding parameter or sequence.

Handshake signal description:

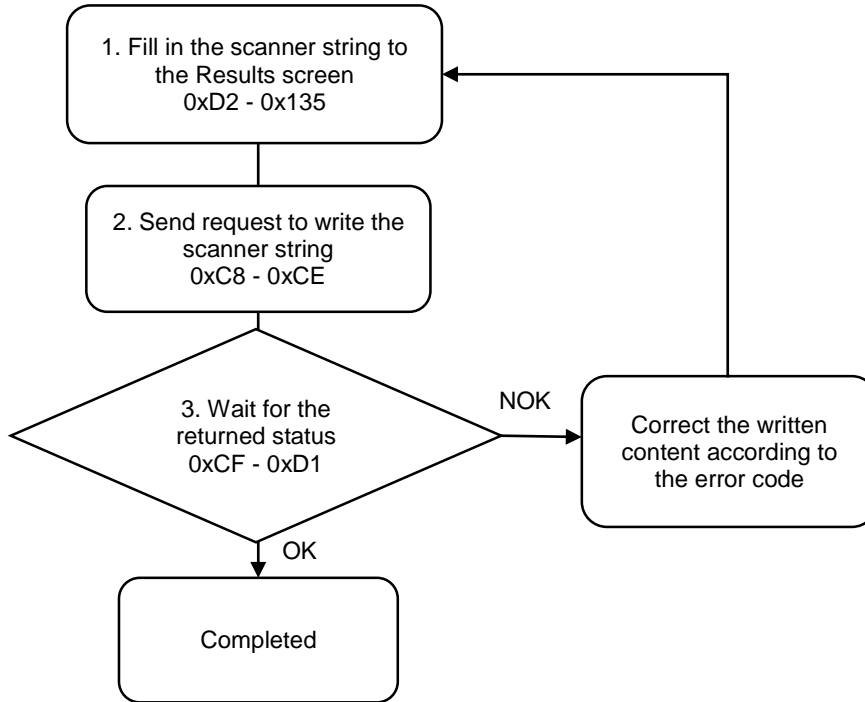

1. Fill in the scanner string to 0xD2 - 0x135.

Modbus (Hex)	Function	Description
D2 - 135	Scanner string (100 words)	ASCII code

2. Fill in the write request to 0xC8 - 0xCE.

Modbus (Hex)	Write / Read request	Write
C8	Function code	401
C9	Version number	0
CA	Tool 1 / Tool 2	0: Tool 1; 1: Tool 2
CB	Reserved	-
CC	Reserved	-
CD	Reserved	-
CE	Request to send command	1 (fill in lastly)

3. Then check whether the writing is successful from the returned status in 0xCF - 0xD1.

Modbus (Hex)	Returned status	Description
CF	Function code	401
D0	Returned status	1: OK; 2: NOK
D1	Error code	Error code

If successful, the returned status (0xD0) is read as 1.

If failed, the returned status (0xD1) is read as 2. The error codes are as follows:

Code	Error description	Description
1	Tool 1 / Tool 2	Must be 0 or 1
2	Matching failure in Barcode Scanner mode	Failed to match the strings

#402 Write to clear all errors

Content description:

Use function code #402 to remove the error messages.

Handshake signal description:

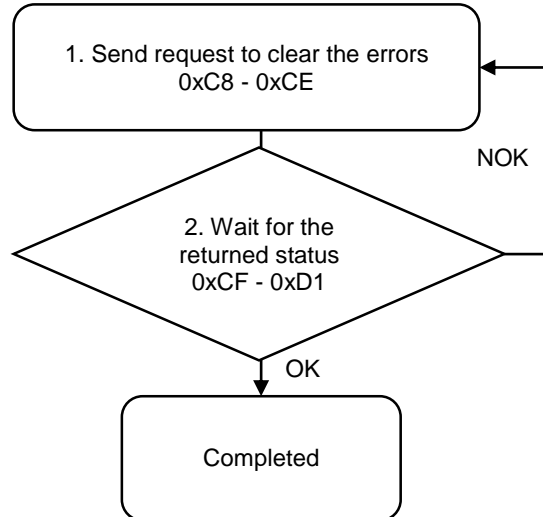

A

1. Fill in the write request to 0xC8 - 0xCE.

Modbus (Hex)	Write / Read request	Write
C8	Function code	402
C9	Version number	0
CA	Reserved	-
CB	Reserved	-
CC	Reserved	-
CD	Reserved	-
CE	Request to send command	1 (fill in lastly)

2. Then check whether the writing is successful from the returned status in 0xCF - 0xD1.

Modbus (Hex)	Returned status	Description
CF	Function code	402
D0	Returned status	1: OK; 2: NOK
D1	Error code	Error code

If successful, the returned status (0xD0) is read as 1, and all error messages in the status area are cleared.

If failed, the returned status (0xD1) is read as 2.

#403 Write to reset the operation progress

Content description:

Use function code #403 to reset the operation progress in the Results screen.

Handshake signal description:

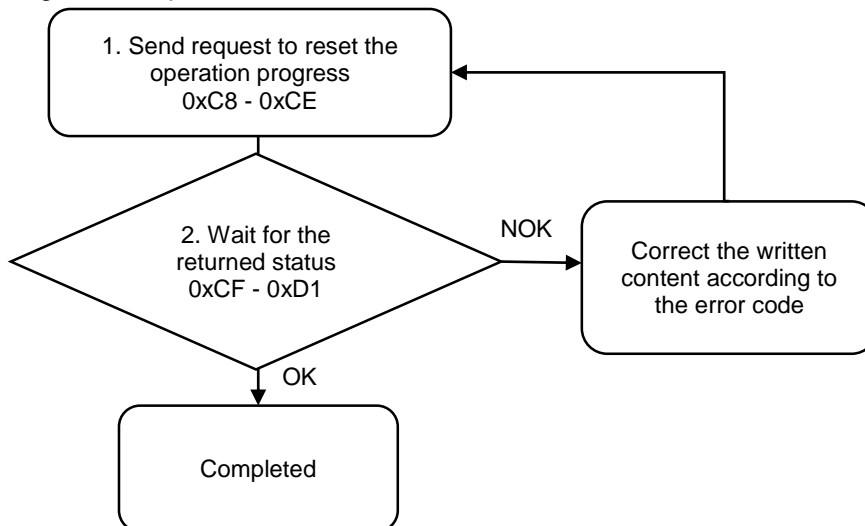

1. Fill in the write request to 0xC8 - 0xCE.

Modbus (Hex)	Write / Read request	Write
C8	Function code	403
C9	Version number	0
CA	Tool 1 / Tool 2	0: Tool 1; 1: Tool 2
CB	Reserved	-
CC	Reserved	-
CD	Reserved	-
CE	Request to send command	1 (fill in lastly)

2. Then check whether the writing is successful from the returned status in 0xCF - 0xD1.

Modbus (Hex)	Returned status	Description
CF	Function code	403
D0	Returned status	1: OK; 2: NOK
D1	Error code	Error code

If successful, the returned status (0xD0) is read as 1, and the total screw quantity, parameter quantity, and screw quantity set in the parameter are cleared from the status area.

If failed, the returned status (0xD1) is read as 2. The error code is as follows:

Code	Error description	Description
1	Tool 1 / Tool 2	Must be 0 or 1

#404 Write to execute the previous step

Content description:

Use function code #404 to execute to the parameters of the previous screw.

Handshake signal description:

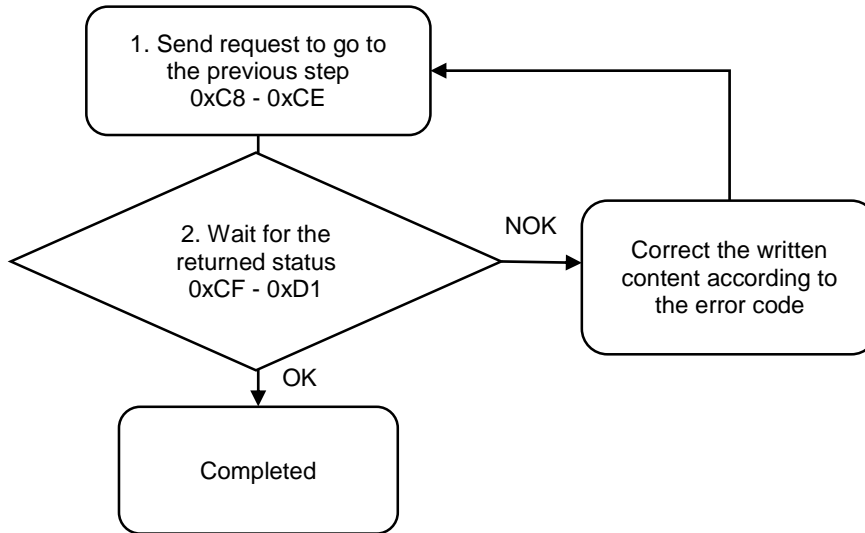

A

1. Fill in the write request to 0xC8 - 0xCE.

Modbus (Hex)	Write / Read request	Write
C8	Function code	404
C9	Version number	0
CA	Tool 1 / Tool 2	0: Tool 1; 1: Tool 2
CB	Reserved	-
CC	Reserved	-
CD	Reserved	-
CE	Request to send command	1 (fill in lastly)

2. Then check whether the writing is successful from the returned status in 0xCF - 0xD1.

Modbus (Hex)	Returned status	Description
CF	Function code	404
D0	Returned status	1: OK; 2: NOK
D1	Error code	Error code

If successful, the returned status (0xD0) is read as 1, and the screw progress in the status area shows the parameters for the previous screw.

If failed, the returned status (0xD1) is read as 2. The error code is as follows:

Code	Error description	Description
1	Tool 1 / Tool 2	Must be 0 or 1

#405 Write to execute the next step

Content description:

Use function code #405 to execute to the parameters of the next screw.

Handshake signal description:

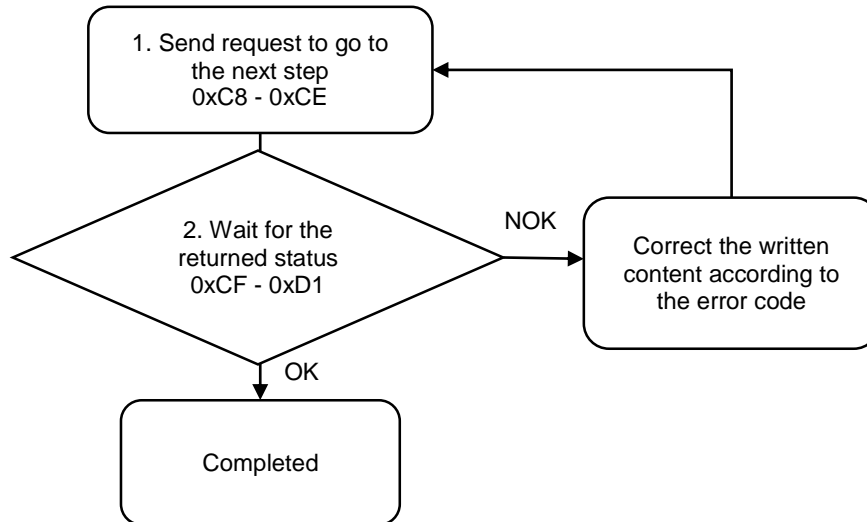

1. Fill in the write request to 0xC8 - 0xCE.

Modbus (Hex)	Write / Read request	Write
C8	Function code	405
C9	Version number	0
CA	Tool 1 / Tool 2	0: Tool 1; 1: Tool 2
CB	Reserved	-
CC	Reserved	-
CD	Reserved	-
CE	Request to send command	1 (fill in lastly)

2. Then check whether the writing is successful from the returned status in 0xCF - 0xD1.

Modbus (Hex)	Returned status	Description
CF	Function code	405
D0	Returned status	1: OK; 2: NOK
D1	Error code	Error code

If successful, the returned status (0xD0) is read as 1, and the screw progress in the status area shows the parameters for the next screw.

If failed, the returned status (0xD1) is read as 2. The error code is as follows:

Code	Error description	Description
1	Tool 1 / Tool 2	Must be 0 or 1

#406 Write to restrict tightening operation

Content description:

Use function code #406 to restrict the user from performing the tightening operations.

Handshake signal description:

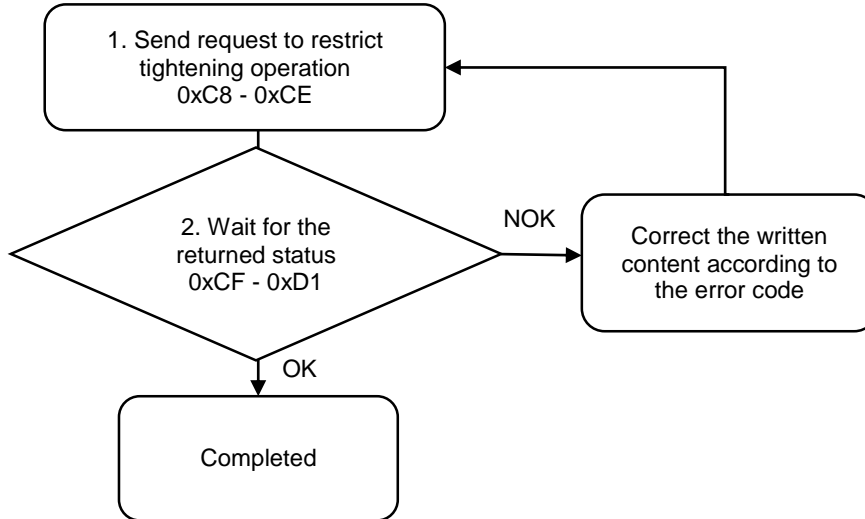

1. Fill in the write request to 0xC8 - 0xCE.

Modbus (Hex)	Write / Read request	Write
C8	Function code	406
C9	Version number	0
CA	Tool 1 / Tool 2	0: Tool 1; 1: Tool 2
CB	Unlock / lock	0: unlock; 1: lock
CC	Reserved	-
CD	Reserved	-
CE	Request to send command	1 (fill in lastly)

2. Then check whether the writing is successful from the returned status in 0xCF - 0xD1.

Modbus (Hex)	Returned status	Description
CF	Function code	406
D0	Returned status	1: OK; 2: NOK
D1	Error code	Error code

If successful, the returned status (0xD0) is read as 1. The servo screwdriver is now restricted from performing tightening operations until the next #406 command releases the restriction.

If failed, the returned status (0xD1) is read as 2. The error code is as follows:

Code	Error description	Description
1	Tool 1 / Tool 2	Must be 0 or 1

A

#407 Write to restrict loosening operation

Content description:

Use function code #407 to restrict the user from performing loosening operations.

Handshake signal description:

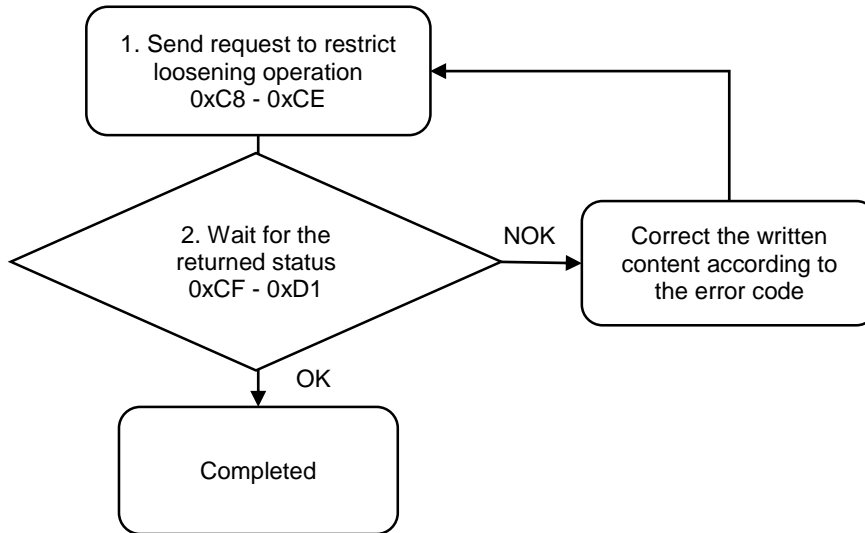

1. Fill in the write request to 0xC8 - 0xCE.

Modbus (Hex)	Write / Read request	Write
C8	Function code	407
C9	Version number	0
CA	Tool 1 / Tool 2	0: Tool 1; 1: Tool 2
CB	Unlock / lock	0: unlock; 1: lock
CC	Reserved	-
CD	Reserved	-
CE	Request to send command	1 (fill in lastly)

2. Then check whether the writing is successful from the returned status in 0xCF - 0xD1.

Modbus (Hex)	Returned status	Description
CF	Function code	407
D0	Returned status	1: OK; 2: NOK
D1	Error code	Error code

If successful, the returned status (0xD0) is read as 1. The servo screwdriver is now restricted from performing loosening operations until the next #407 command releases the restriction.

If failed, the returned status (0xD1) is read as 2. The error code is as follows:

Code	Error description	Description
1	Tool 1 / Tool 2	Must be 0 or 1

#408 Write the scanner advanced settings

Content description:

Use function code #408 to set the scanner advanced settings.

Handshake signal description:

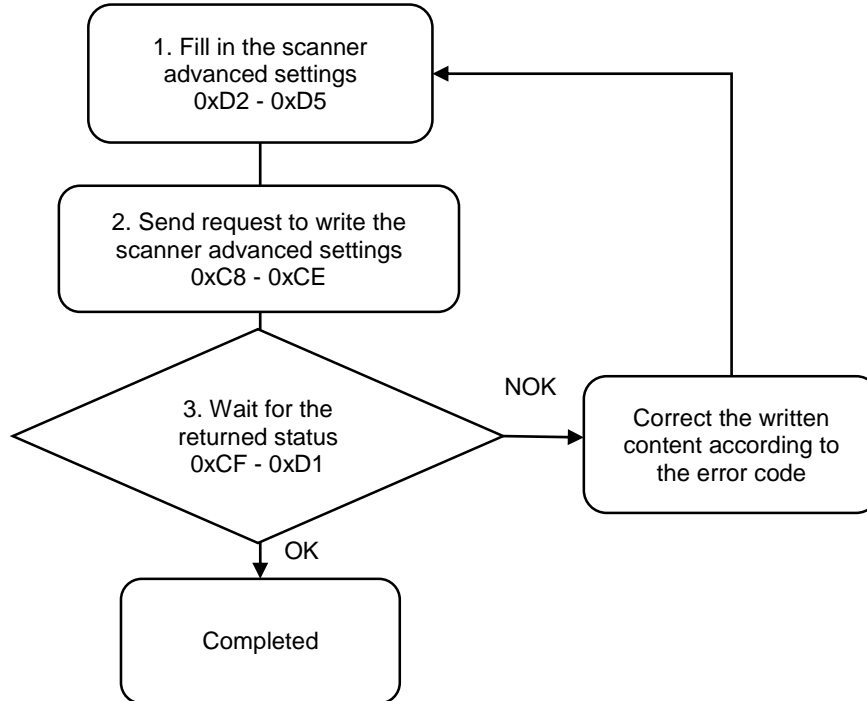

A

1. Fill in the scanner advanced settings to 0xD2 - 0xD5.

Modbus (Hex)	Function	Description
D2	Start position (char.) for saving scanner string	1 to 200
D3	End position (char.) for saving scanner string	1 to 200
D4	Start position (char.) for matching scanner string	1 to 200
D5	End position (char.) for matching scanner string	1 to 200

Example 1: the scanner string is "ABCDE". Set to save the scanner string from the 2nd to 4th characters. The system then saves the 3-character string "BCD" to the operating screen.

Example 2: the scanner string is "ABCDE", and the switching method is set as Barcode Scanner. Set to match the scanner string from the 2nd to 4th characters. The system then matches the 3-character string "BCD" with the 500 sets of the corresponding parameter or sequence strings.

2. Fill in the write request to 0xC8 - 0xCE.

Modbus (Hex)	Write / Read request	Write
C8	Function code	408
C9	Version number	0
CA	Tool 1 / Tool 2	0: Tool 1; 1: Tool 2
CB - CD	Reserved	-
CE	Request to send command	1 (fill in lastly)

3. Then check whether the writing is successful from the returned status in 0xCF - 0xD1.

Modbus (Hex)	Returned status	Description
CF	Function code	408
D0	Returned status	1: OK; 2: NOK
D1	Error code	Error code

If successful, the returned status (0xD0) is read as 1.

If failed, the returned status (0xD1) is read as 2. The error codes are as follows:

Code	Error description	Description
1	Tool 1 / Tool 2	Must be 0 or 1
2	Set value exceeds range	1 to 200

#450 Read the switching method of Sources

Content description:

Use function code #450 to read the current switching method ID.

Handshake signal description:

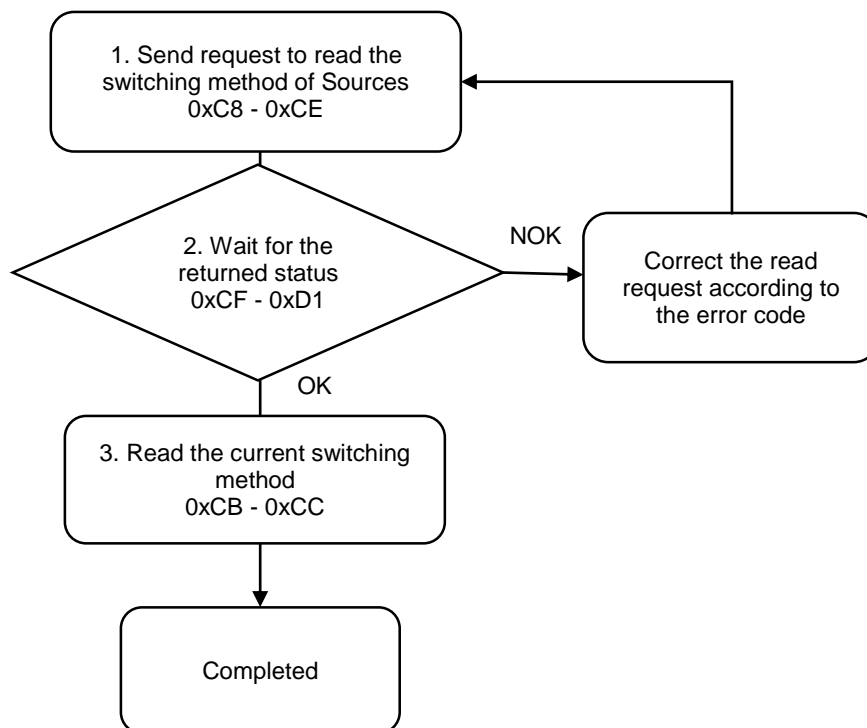

1. Fill in the read request to 0xC8 - 0xCE.

Modbus (Hex)	Write / Read request	Write
C8	Function code	450
C9	Version number	0
CA	Tool 1 / Tool 2	0: Tool 1; 1: Tool 2
CB	Reserved	-
CC	Reserved	-
CD	Reserved	-
CE	Request to send command	1 (fill in lastly)

2. Check whether the reading is successful from the returned status in 0xCF - 0xD1.

Modbus (Hex)	Returned status	Description
CF	Function code	450
D0	Returned status	1: OK; 2: NOK
D1	Error code	Error code

If successful, the returned status (0xD0) is read as 1.

If failed, the returned status (0xD0) is read as 2. The error code is as follows:

Code	Error description	Description
1	Tool 1 / Tool 2	Must be 0 or 1

3. Obtain the information from 0xCB.

Modbus (Hex)	Write / Read request	Write
CB	Switching method ID	Manual: 1 Screw bit selector: 1 to 255 Barcode scanner: 1 to 500 (0: the controller is not running)

A

#451 Read the scanner string

Content description:

Use function code #451 to read the current content in the scanner string field of the controller.

Handshake signal description:

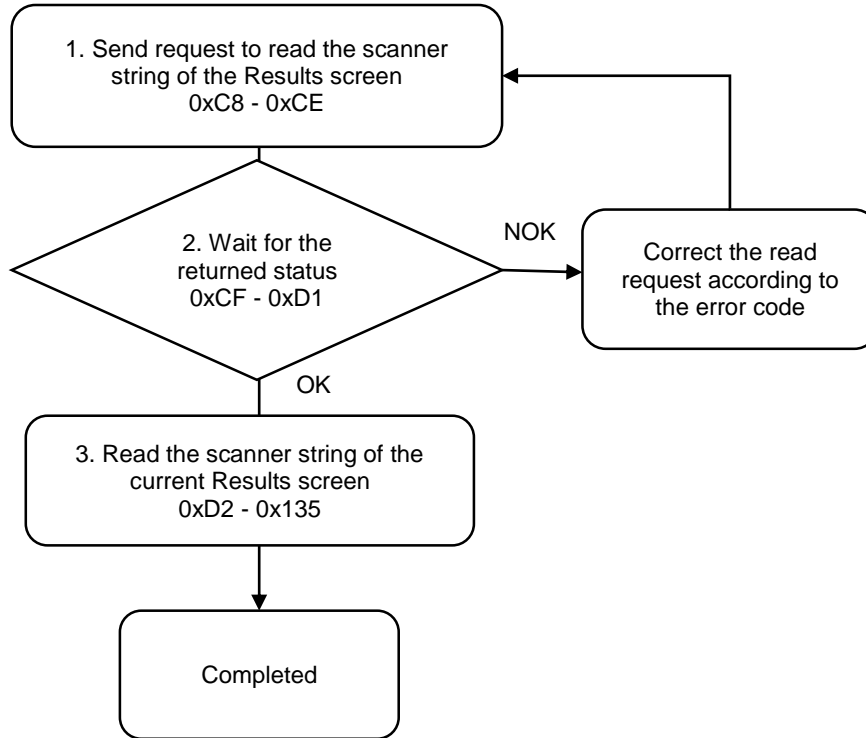

1. Fill in the read request to 0xC8 - 0xCE.

Modbus (Hex)	Write / Read request	Write
C8	Function code	451
C9	Version number	0
CA	Tool 1 / Tool 2	0: Tool 1; 1: Tool 2
CB - CD	Reserved	-
CE	Request to send command	1 (fill in lastly)

2. Check whether the reading is successful from the returned status in 0xCF - 0xD1.

Modbus (Hex)	Returned status	Description
CF	Function code	451
D0	Returned status	1: OK; 2: NOK
D1	Error code	Error code

If successful, the returned status (0xD0) is read as 1.

If failed, the returned status (0xD0) is read as 2. The error code is as follows:

Code	Error description	Description
1	Tool 1 / Tool 2	Must be 0 or 1

3. Read the scanner string in 0xD2 - 0x135.

Modbus (Hex)	Function	Description
D2 - 135	Scanner string (100 words)	ASCII code

#452 Read the scanner advanced settings

Content description:

Use function code #452 to read the scanner advanced settings.

Handshake signal description:

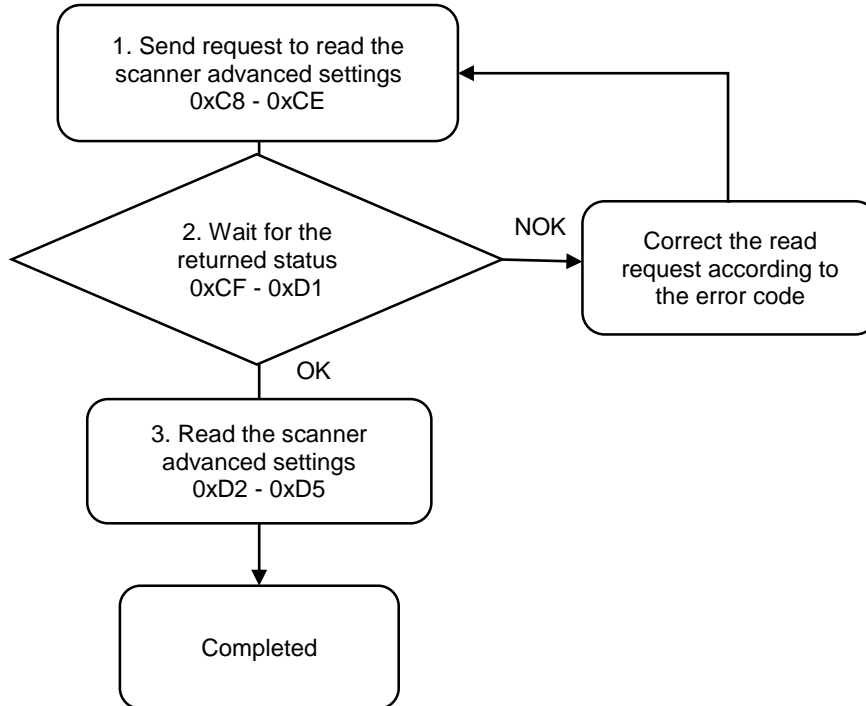

1. Fill in the read request to 0xC8 - 0xCE.

Modbus (Hex)	Write / Read request	Write
C8	Function code	452
C9	Version number	0
CA	Tool 1 / Tool 2	0: Tool 1; 1: Tool 2
CB	Reserved	-
CC	Reserved	-
CD	Reserved	-
CE	Request to send command	1 (fill in lastly)



2. Check whether the reading is successful from the returned status in 0xCF - 0xD1.

Modbus (Hex)	Returned status	Description
CF	Function code	452
D0	Returned status	1: OK; 2: NOK
D1	Error code	Error code

If successful, the returned status (0xD0) is read as 1.

If failed, the returned status (0xD0) is read as 2. The error code is as follows:

Code	Error description	Description
1	Tool 1 / Tool 2	Must be 0 or 1

3. Read the scanner advanced settings in 0xD2 - 0xD5.

Modbus (Hex)	Function	Description
D2	Start position (char.) for saving scanner string	1 to 200
D3	End position (char.) for saving scanner string	1 to 200
D4	Start position (char.) for matching scanner string	1 to 200
D5	End position (char.) for matching scanner string	1 to 200

A

A.3.5 Controller operations

Controller			
Function code	Function name	Function code	Function name
#500	Write the request for permissions login	#550	Read the Ethernet settings
#501	Write the request for password change	#551	Read the page permissions
#502	Write the request for permissions logout	#552	Read the firmware version
#503	Write the page permissions	#553	Read the DI/DO functions
#504	Write the Ethernet settings	#554	Read the DI/DO conversion table
#505	Request for factory reset	#555	Read the default torque unit
#506	Write the buzzer sound pattern	#556	Read the default tool start condition
#507	Write the DI/DO functions	-	-
#508	Write the DI/DO conversion table	-	-
#509	Write the default torque unit	-	-
#510	Write the default tool start condition	-	-

A

#500 Write the request for permissions login

Content description:

Use function code #500 to switch the logged-in controller permissions through the host controller.

Handshake signal description:

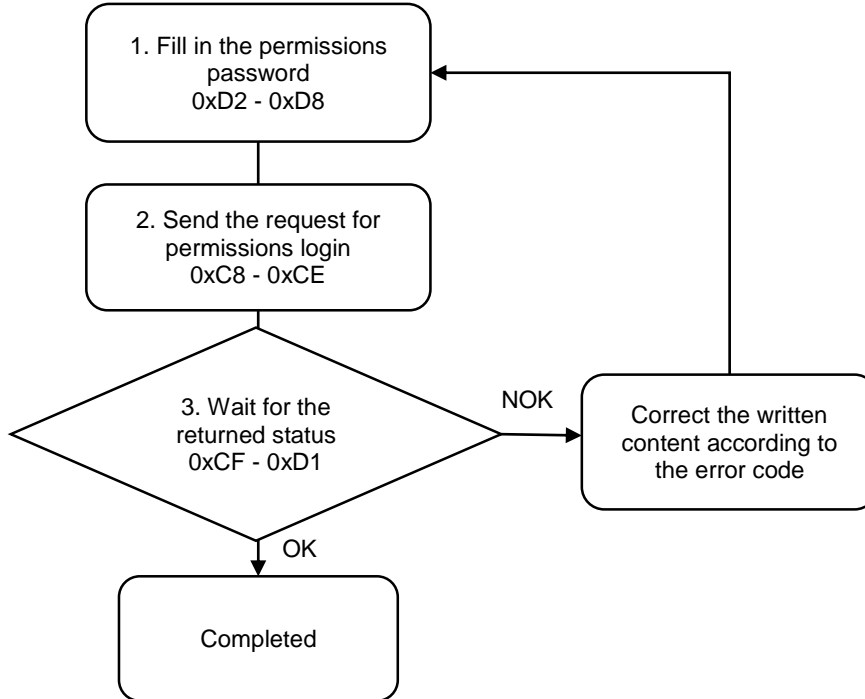

1. Fill in the permissions password to 0xD2 - 0xD8.

Modbus (Hex)	Function	Description
D2 - D8	Permissions password (10 words)	Numbers converted to ASCII

2. Fill in the write request to 0xC8 - 0xCE.

Modbus (Hex)	Write / Read request	Write
C8	Function code	500
C9	Version number	0
CA	User permissions	2: User2 permissions 3: User3 permissions 4: User4 permissions 5: User5 permissions 6: Admin permissions (highest level)
CB	Reserved	-
CC	Reserved	-
CD	Reserved	-
CE	Request to send command	1 (fill in lastly)

- Then check whether the writing is successful from the returned status in 0xCF - 0xD1.

Modbus (Hex)	Returned status	Description
CF	Function code	500
D0	Returned status	1: OK; 2: NOK
D1	Error code	Error code

If successful, the returned status (0xD0) is read as 1, and the user permissions are logged in.

If failed, the returned status (0xD1) is read as 2. The error codes are as follows:

Code	Error description	Description
1	User permissions	Exceeds the range of 2 to 6
2	Login failed	-

#501 Write the request for password change

Content description:

Use function code #501 to change the controller password through the host controller.

Handshake signal description:

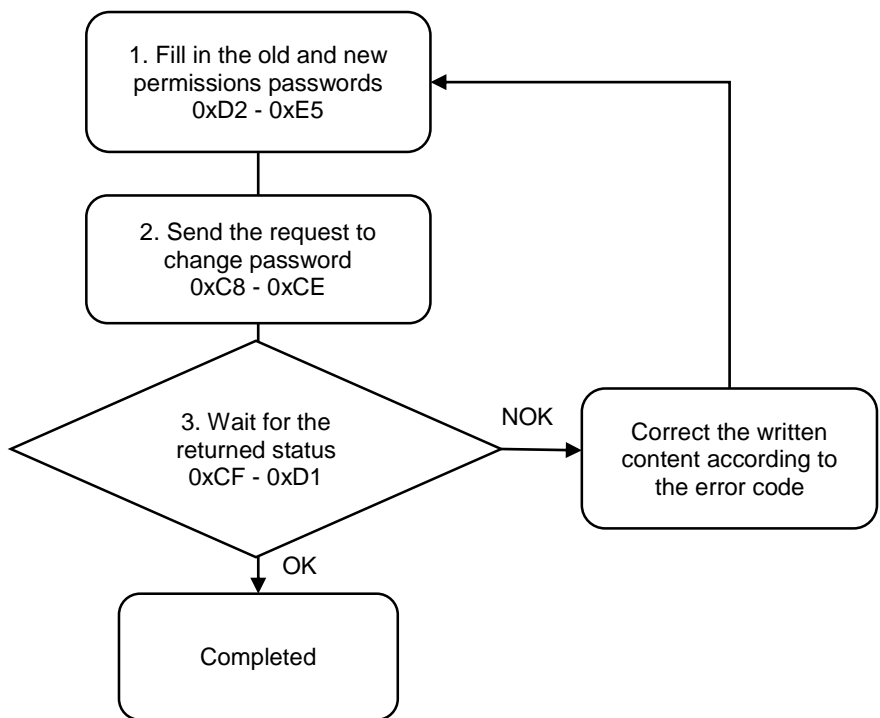

- Fill in the old password to 0xD2 - 0xDB, and the new password to 0xDC - 0xE5.

Modbus (Hex)	Function	Description
D2 - DB	Old password (10 words)	Numbers converted to ASCII
DC - E5	New password (10 words)	Numbers converted to ASCII



2. Fill in the write request to 0xC8 - 0xCE.

Modbus (Hex)	Write / Read request	Write
C8	Function code	501
C9	Version number	0
CA	User permissions	2: User2 permissions 3: User3 permissions 4: User4 permissions 5: User5 permissions 6: Admin permissions (highest level)
CB	Reserved	-
CC	Reserved	-
CD	Reserved	-
CE	Request to send command	1 (fill in lastly)

3. Then check whether the writing is successful from the returned status in 0xCF - 0xD1.

Modbus (Hex)	Returned status	Description
CF	Function code	501
D0	Returned status	1: OK; 2: NOK
D1	Error code	Error code

If successful, the returned status (0xD0) is read as 1, and the password has been successfully changed.

If failed, the returned status (0xD1) is read as 2. The error codes are as follows:

Code	Error description	Description
1	User permissions	Exceeds the range of 2 to 6
2	Password change failed	-

A

#502 Write the request for permissions logout

Content description:

Use function code #502 to logout the controller permissions through the host controller. After logout, the default username is User1.

Handshake signal description:

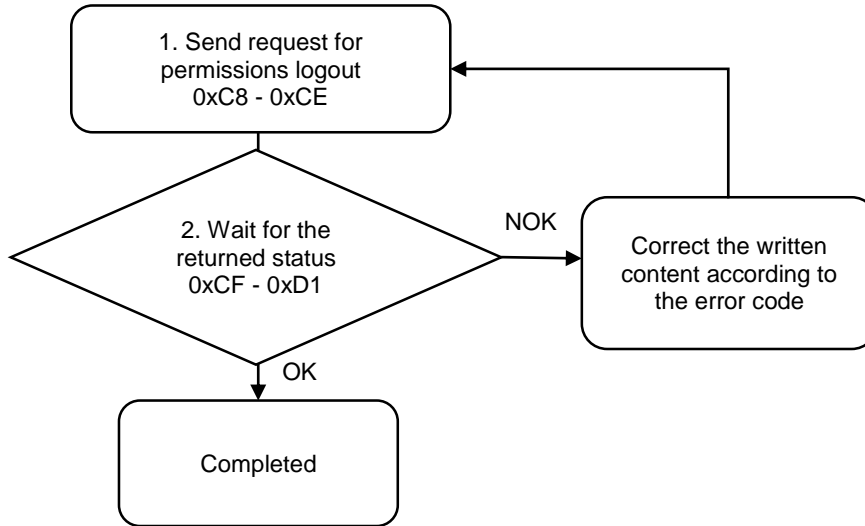

1. Fill in the write request to 0xC8 - 0xCE.

Modbus (Hex)	Write / Read request	Write
C8	Function code	502
C9	Version number	0
CA	Reserved	-
CB	Reserved	-
CC	Reserved	-
CD	Reserved	-
CE	Request to send command	1 (fill in lastly)

2. Then check whether the writing is successful from the returned status in 0xCF - 0xD1.

Modbus (Hex)	Returned status	Description
CF	Function code	502
D0	Returned status	1: OK; 2: NOK
D1	Error code	Error code

If successful, the returned status (0xD0) is read as 1, and the permissions are logged out.

If failed, the returned status (0xD1) is read as 2. The error code is as follows:

Code	Error description	Description
1	Logout failure	-



#503 Write the page permissions

Content description:

Use function code #503 to set the page editing and access permissions for different users.

Handshake signal description:

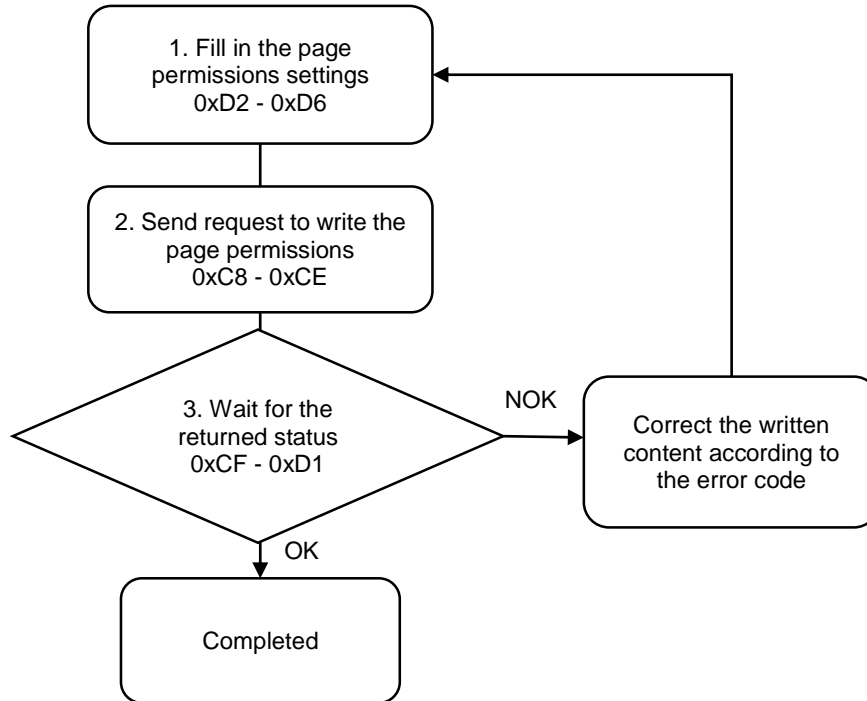

1. Fill in the page permissions settings to 0xD2 - 0xD6.

Modbus (Hex)	Function	Description
D2	User1 page permissions	BIT0: Parameters
D3	User2 page permissions	BIT1: Sequence
D4	User3 page permissions	BIT2: Sources
D5	User4 page permissions	BIT3: Controller
D6	User5 page permissions	BIT4: Tool
		BIT5: operation for screw progress
		BIT6: Clear the production report entries
		Bit7: Clear the error and warning report entries

2. Fill in the page permissions write request to 0xC8 - 0xCE.

Modbus (Hex)	Write / Read request	Write
C8	Function code	503
C9	Version number	0
CA	Confirm command	99
CB	Reserved	-
CC	Reserved	-
CD	Reserved	-
CE	Request to send command	1 (fill in lastly)

3. Then check whether the writing is successful from the returned status in 0xCF - 0xD1.

Modbus (Hex)	Returned status	Description
CF	Function code	503
D0	Returned status	1: OK; 2: NOK
D1	Error code	Error code

If successful, the returned status (0xD0) is read as 1.

If failed, the returned status (0xD1) is read as 2. The error code is as follows:

Code	Error description	Description
1	Confirm command	Must be 99

#504 Write the Ethernet settings

Content description:

Use function code #504 to set the Ethernet IP.

Handshake signal description:

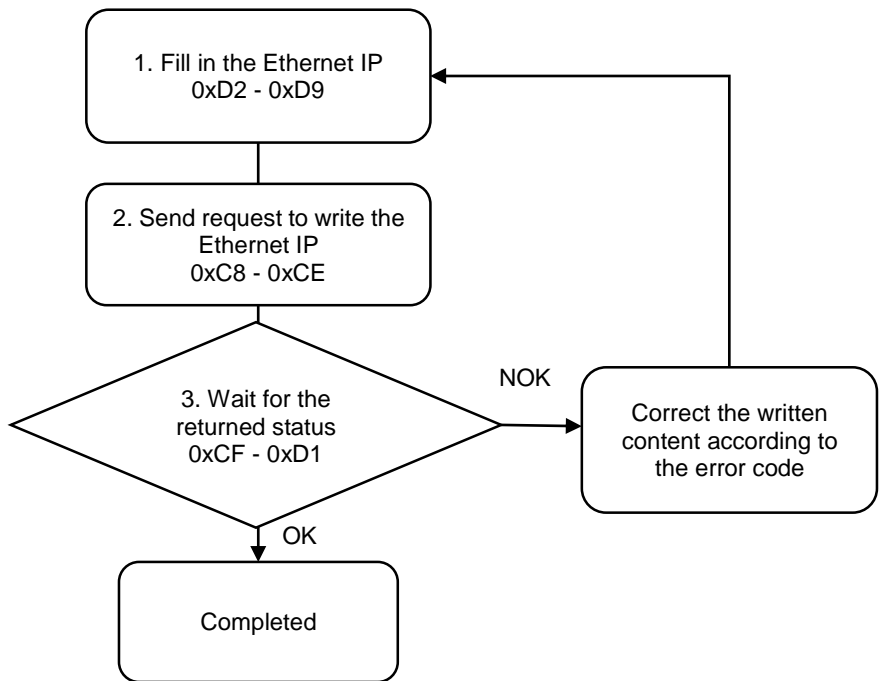

1. Fill in the content of the Ethernet IP and subnet mask to 0xD2 - 0xD9.

Modbus (Hex)	Function	Description
D2	IP1 address	Default: 192
D3	IP2 address	Default: 168
D4	IP3 address	Default: 1
D5	IP4 address	Default: 11
D6	Subnet mask 1	Default: 255
D7	Subnet mask 2	Default: 255
D8	Subnet mask 3	Default: 255
D9	Subnet mask 4	Default: 0

A

2. Fill in the write request to 0xC8 - 0xCE.

Modbus (Hex)	Write / Read request	Write
C8	Function code	504
C9	Version number	0
CA	Confirm command	99
CB	Reserved	-
CC	Reserved	-
CD	Reserved	-
CE	Request to send command	1 (fill in lastly)

3. Then check whether the writing is successful from the returned status in 0xCF - 0xD1.

Modbus (Hex)	Returned status	Description
CF	Function code	504
D0	Returned status	1: OK; 2: NOK
D1	Error code	Error code

If successful, the returned status (0xD0) is read as 1.

If failed, the returned status (0xD1) is read as 2. The error code is as follows:

Code	Error description	Description
1	Confirm command	Must be 99

#505 Request for factory reset

Content description:

Use function code #505 to request for factory reset.

Handshake signal description:

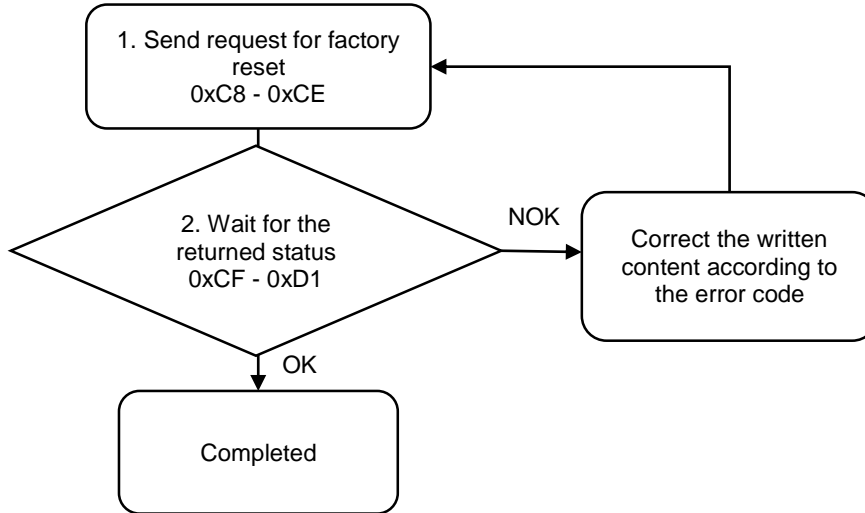

1. Fill in the write request to 0xC8 - 0xCE.

Modbus (Hex)	Write / Read request	Write
C8	Function code	505
C9	Version number	0
CA	Confirm command	99
CB	Reserved	-
CC	Reserved	-
CD	Reserved	-
CE	Request to send command	1 (fill in lastly)

Note:

(1) Please note that if you restore factory settings, all data will be deleted and the default values will be restored.

(2) If you use the highest permissions account (Admin) to restore factory settings, the Ethernet IP will return to the default, and the error reports and warning reports will be cleared.

2. Then check whether the writing is successful from the returned status in 0xCF - 0xD1.

Modbus (Hex)	Returned status	Description
CF	Function code	505
D0	Returned status	1: OK; 2: NOK
D1	Error code	Error code

If successful, the returned status (0xD0) is read as 1.

If failed, the returned status (0xD1) is read as 2. The error code is as follows:

Code	Error description	Description
1	Confirm command	Must be 99

A

#506 Write the buzzer sound pattern

Content description:

Use function code #506 to set the buzzer sound pattern.

Handshake signal description:

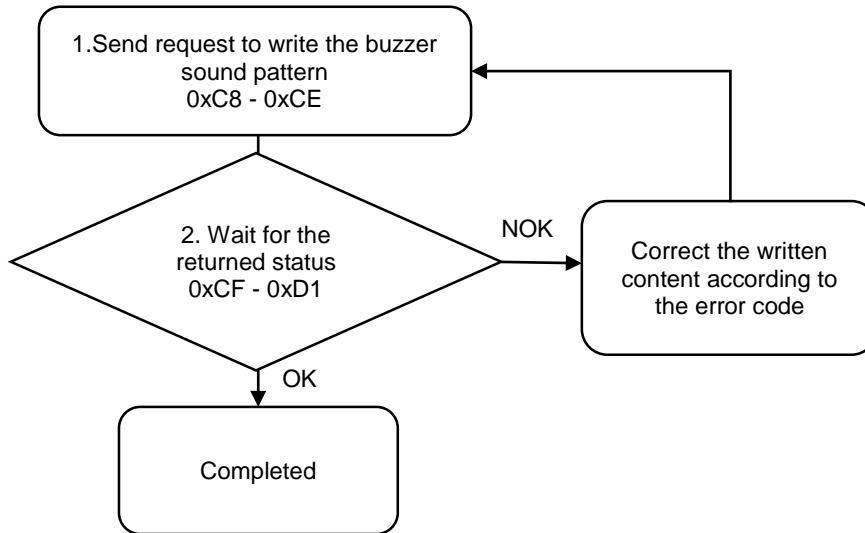

1. Fill in the write request to 0xC8 - 0xCE.

Modbus (Hex)	Write / Read request	Write
C8	Function code	506
C9	Version number	0
CA	Buzzer sound pattern for error signal	0: mute 1: one long beep 2: one short beep 3: two short beeps
CB	Buzzer sound pattern for finished signal	0: mute 1: one long beep 2: one short beep 3: two short beeps
CC	Reserved	-
CD	Reserved	-
CE	Request to send command	1 (fill in lastly)

2. Then check whether the writing is successful from the returned status in 0xCF - 0xD1.

Modbus (Hex)	Returned status	Description
CF	Function code	506
D0	Returned status	1: OK; 2: NOK
D1	Error code	Error code

If successful, the returned status (0xD0) is read as 1.

If failed, the returned status (0xD1) is read as 2. The error code is as follows:

Code	Error description	Description
1	Buzzer sound pattern	Exceeds the range of 0 to 3

#507 Write the DI/DO functions

Content description:

Use function code #507 to set the DI/DO functions.

Handshake signal description:

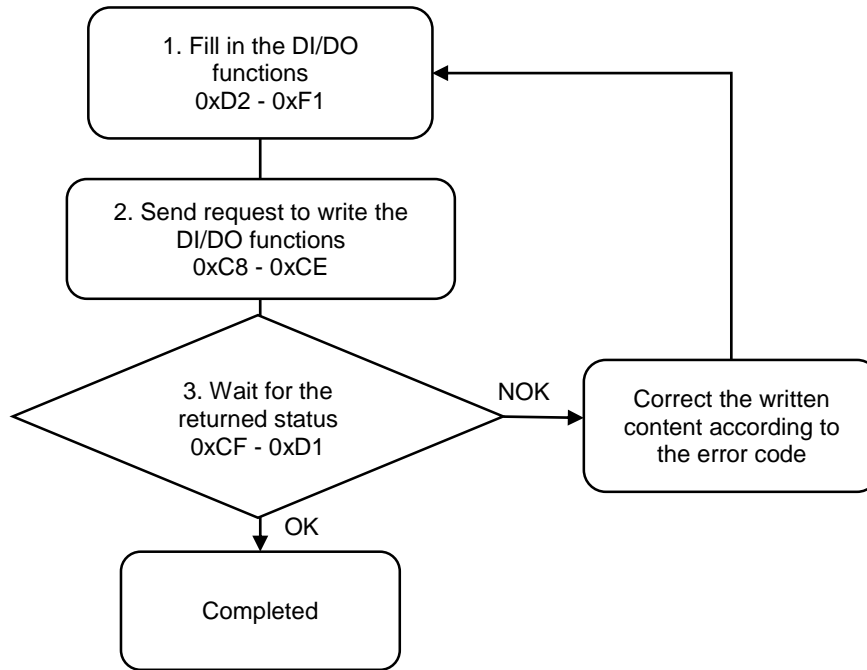

1. Fill in the DI/DO functions for one tool to 0xD2 - 0xF1. (NO: normally open; NC: normally closed)

Modbus (Hex)	Function	Description
D2	DO1 NO / NC	0: NO; 1: NC
D3	DO2 NO / NC	0: NO; 1: NC
D4	DO3 NO / NC	0: NO; 1: NC
D5	DO4 NO / NC	0: NO; 1: NC
D6	DO5 NO / NC	0: NO; 1: NC
D7	DO6 NO / NC	0: NO; 1: NC
D8	DO7 NO / NC	0: NO; 1: NC
D9	DO8 NO / NC	0: NO; 1: NC
DA	DO1 function code	0: not in use
DB	DO2 function code	1: ready
DC	DO3 function code	2: running
DD	DO4 function code	3: tightening OK
DE	DO5 function code	4: tightening NOK
DF	DO6 function code	5: loosening OK
E0	DO7 function code	6: loosening NOK
E1	DO8 function code	7: total screw quantity reached
E2	DI1 NO / NC	8 to 16: reserved
		17 to 24: parameter ID output (Bit 1 - 8)
		25 to 32: screw progress output (Bit 1 - 8)
		33 to 40: sequence ID output (Bit 1 - 8)
		41 to 48: bit ID output (Bit 1 - 8)
		0: NO; 1: NC

A

Modbus (Hex)	Function	Description
E3	DI2 NO / NC	0: NO; 1: NC
E4	DI3 NO / NC	0: NO; 1: NC
E5	DI4 NO / NC	0: NO; 1: NC
E6	DI5 NO / NC	0: NO; 1: NC
E7	DI6 NO / NC	0: NO; 1: NC
E8	DI7 NO / NC	0: NO; 1: NC
E9	DI8 NO / NC	0: NO; 1: NC
EA	DI1 function code	0: not in use
EB	DI2 function code	1: start tightening
EC	DI3 function code	2: start loosening
ED	DI4 function code	3: emergency stop
EE	DI5 function code	4: clear error
EF	DI6 function code	5: reset total screw quantity
F0	DI7 function code	6: next step
F1	DI8 function code	7: previous step
		8: start tightening (pulse signal)
		9: start loosening (pulse signal)
		10: start tightening (dual-tool)
		11: start loosening (dual-tool)
		12 to 15: reserved
		16 to 23: parameter ID input (Bit 1 - 8)
		24 to 31: screw progress input (Bit 1 - 8)
		32 to 39: sequence ID input (Bit 1 - 8)
		40 to 47: bit ID input (Bit 1 - 8)

2. Fill in the write request to 0xC8 - 0xCE.

Modbus (Hex)	Write / Read request	Write
C8	Function code	507
C9	Version number	0
CA	Tool 1 / Tool 2	0: Tool 1; 1: Tool 2
CB	Reserved	-
CC	Reserved	-
CD	Reserved	-
CE	Request to send command	1 (fill in lastly)

3. Then check whether the writing is successful from the returned status in 0xCF - 0xD1.

Modbus (Hex)	Returned status	Description
CF	Function code	507
D0	Returned status	1: OK; 2: NOK
D1	Error code	Error code

If successful, the returned status (0xD0) is read as 1, and the DI/DO functions has been set to Tool 1 / Tool 2.

If failed, the returned status (0xD1) is read as 2. The error code is as follows:

Code	Error description	Description
1	Tool 1 / Tool 2	Must be 0 or 1

#508 Write the DI/DO conversion table

Content description:

Use function code #508 to set the DI/DO conversion tables.

- A. Set the bit DO conversion table.
- B. Set the bit DI conversion table.
- C. Set the parameter DO conversion table.
- D. Set the screw progress DO conversion table.
- E. Set the sequence DO conversion table.



Handshake signal description:

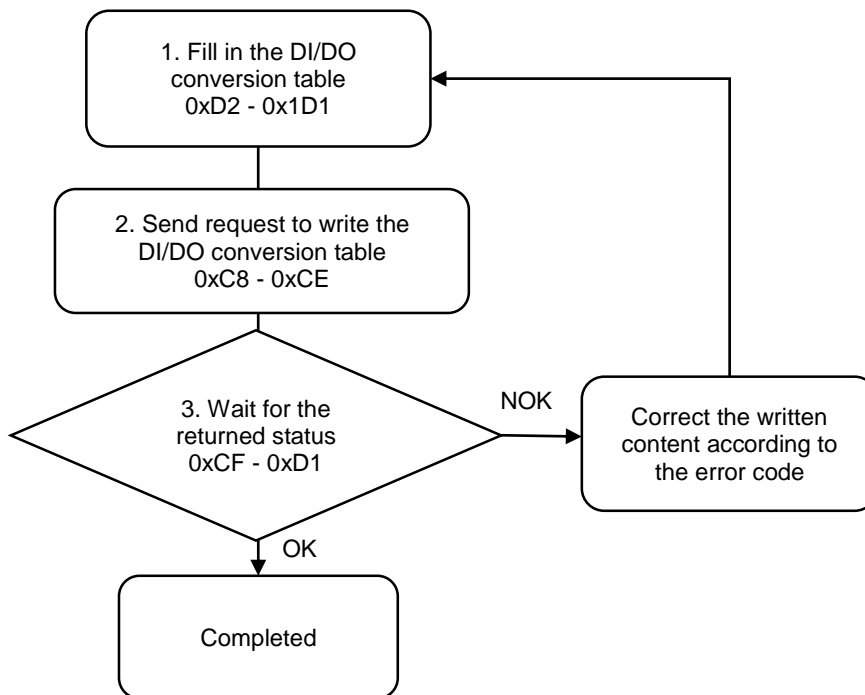

1. Fill in the DI/DO conversion table to 0xD2 - 0x1D1.

Modbus (Hex)	Function	Description
D2	DEC value corresponding to ID 0	0 to 255
D3	DEC value corresponding to ID 1	0 to 255
D4	DEC value corresponding to ID 2	0 to 255
D5	DEC value corresponding to ID 3	0 to 255
D6	DEC value corresponding to ID 4	0 to 255
D7	DEC value corresponding to ID 5	0 to 255
D8	DEC value corresponding to ID 6	0 to 255
D9	DEC value corresponding to ID 7	0 to 255
DA	DEC value corresponding to ID 8	0 to 255
DB	DEC value corresponding to ID 9	0 to 255
DC	DEC value corresponding to ID 10	0 to 255
DD	DEC value corresponding to ID 11	0 to 255

Modbus (Hex)	Function	Description
DE	DEC value corresponding to ID 12	0 to 255
DF	DEC value corresponding to ID 13	0 to 255
E0	DEC value corresponding to ID 14	0 to 255
E1	DEC value corresponding to ID 15	0 to 255
E2	DEC value corresponding to ID 16	0 to 255
E3	DEC value corresponding to ID 17	0 to 255
E4	DEC value corresponding to ID 18	0 to 255
E5	DEC value corresponding to ID 19	0 to 255
E6	DEC value corresponding to ID 20	0 to 255
E7	DEC value corresponding to ID 21	0 to 255
E8	DEC value corresponding to ID 22	0 to 255
E9	DEC value corresponding to ID 23	0 to 255
EA	DEC value corresponding to ID 24	0 to 255
EB	DEC value corresponding to ID 25	0 to 255
EC	DEC value corresponding to ID 26	0 to 255
ED	DEC value corresponding to ID 27	0 to 255
EE	DEC value corresponding to ID 28	0 to 255
EF	DEC value corresponding to ID 29	0 to 255
F0	DEC value corresponding to ID 30	0 to 255
F1	DEC value corresponding to ID 31	0 to 255
F2	DEC value corresponding to ID 32	0 to 255
F3	DEC value corresponding to ID 33	0 to 255
F4	DEC value corresponding to ID 34	0 to 255
F5	DEC value corresponding to ID 35	0 to 255
F6	DEC value corresponding to ID 36	0 to 255
F7	DEC value corresponding to ID 37	0 to 255
F8	DEC value corresponding to ID 38	0 to 255
F9	DEC value corresponding to ID 39	0 to 255
FA	DEC value corresponding to ID 40	0 to 255
FB	DEC value corresponding to ID 41	0 to 255
FC	DEC value corresponding to ID 42	0 to 255
FD	DEC value corresponding to ID 43	0 to 255
FE	DEC value corresponding to ID 44	0 to 255
FF	DEC value corresponding to ID 45	0 to 255
100	DEC value corresponding to ID 46	0 to 255
101	DEC value corresponding to ID 47	0 to 255
102	DEC value corresponding to ID 48	0 to 255
103	DEC value corresponding to ID 49	0 to 255
104	DEC value corresponding to ID 50	0 to 255
105	DEC value corresponding to ID 51	0 to 255
106	DEC value corresponding to ID 52	0 to 255
107	DEC value corresponding to ID 53	0 to 255
108	DEC value corresponding to ID 54	0 to 255

Modbus (Hex)	Function	Description
109	DEC value corresponding to ID 55	0 to 255
10A	DEC value corresponding to ID 56	0 to 255
10B	DEC value corresponding to ID 57	0 to 255
10C	DEC value corresponding to ID 58	0 to 255
10D	DEC value corresponding to ID 59	0 to 255
10E	DEC value corresponding to ID 60	0 to 255
10F	DEC value corresponding to ID 61	0 to 255
110	DEC value corresponding to ID 62	0 to 255
111	DEC value corresponding to ID 63	0 to 255
112	DEC value corresponding to ID 64	0 to 255
113	DEC value corresponding to ID 65	0 to 255
114	DEC value corresponding to ID 66	0 to 255
115	DEC value corresponding to ID 67	0 to 255
116	DEC value corresponding to ID 68	0 to 255
117	DEC value corresponding to ID 69	0 to 255
118	DEC value corresponding to ID 70	0 to 255
119	DEC value corresponding to ID 71	0 to 255
11A	DEC value corresponding to ID 72	0 to 255
11B	DEC value corresponding to ID 73	0 to 255
11C	DEC value corresponding to ID 74	0 to 255
11D	DEC value corresponding to ID 75	0 to 255
11E	DEC value corresponding to ID 76	0 to 255
11F	DEC value corresponding to ID 77	0 to 255
120	DEC value corresponding to ID 78	0 to 255
121	DEC value corresponding to ID 79	0 to 255
122	DEC value corresponding to ID 80	0 to 255
123	DEC value corresponding to ID 81	0 to 255
124	DEC value corresponding to ID 82	0 to 255
125	DEC value corresponding to ID 83	0 to 255
126	DEC value corresponding to ID 84	0 to 255
127	DEC value corresponding to ID 85	0 to 255
128	DEC value corresponding to ID 86	0 to 255
129	DEC value corresponding to ID 87	0 to 255
12A	DEC value corresponding to ID 88	0 to 255
12B	DEC value corresponding to ID 89	0 to 255
12C	DEC value corresponding to ID 90	0 to 255
12D	DEC value corresponding to ID 91	0 to 255
12E	DEC value corresponding to ID 92	0 to 255
12F	DEC value corresponding to ID 93	0 to 255
130	DEC value corresponding to ID 94	0 to 255
131	DEC value corresponding to ID 95	0 to 255
132	DEC value corresponding to ID 96	0 to 255

A

Modbus (Hex)	Function	Description
133	DEC value corresponding to ID 97	0 to 255
134	DEC value corresponding to ID 98	0 to 255
135	DEC value corresponding to ID 99	0 to 255
136	DEC value corresponding to ID 100	0 to 255
137	DEC value corresponding to ID 101	0 to 255
138	DEC value corresponding to ID 102	0 to 255
139	DEC value corresponding to ID 103	0 to 255
13A	DEC value corresponding to ID 104	0 to 255
13B	DEC value corresponding to ID 105	0 to 255
13C	DEC value corresponding to ID 106	0 to 255
13D	DEC value corresponding to ID 107	0 to 255
13E	DEC value corresponding to ID 108	0 to 255
13F	DEC value corresponding to ID 109	0 to 255
140	DEC value corresponding to ID 110	0 to 255
141	DEC value corresponding to ID 111	0 to 255
142	DEC value corresponding to ID 112	0 to 255
143	DEC value corresponding to ID 113	0 to 255
144	DEC value corresponding to ID 114	0 to 255
145	DEC value corresponding to ID 115	0 to 255
146	DEC value corresponding to ID 116	0 to 255
147	DEC value corresponding to ID 117	0 to 255
148	DEC value corresponding to ID 118	0 to 255
149	DEC value corresponding to ID 119	0 to 255
14A	DEC value corresponding to ID 120	0 to 255
14B	DEC value corresponding to ID 121	0 to 255
14C	DEC value corresponding to ID 122	0 to 255
14D	DEC value corresponding to ID 123	0 to 255
14E	DEC value corresponding to ID 124	0 to 255
14F	DEC value corresponding to ID 125	0 to 255
150	DEC value corresponding to ID 126	0 to 255
151	DEC value corresponding to ID 127	0 to 255
152	DEC value corresponding to ID 128	0 to 255
153	DEC value corresponding to ID 129	0 to 255
154	DEC value corresponding to ID 130	0 to 255
155	DEC value corresponding to ID 131	0 to 255
156	DEC value corresponding to ID 132	0 to 255
157	DEC value corresponding to ID 133	0 to 255
158	DEC value corresponding to ID 134	0 to 255
159	DEC value corresponding to ID 135	0 to 255
15A	DEC value corresponding to ID 136	0 to 255
15B	DEC value corresponding to ID 137	0 to 255
15C	DEC value corresponding to ID 138	0 to 255
15D	DEC value corresponding to ID 139	0 to 255

Modbus (Hex)	Function	Description
15E	DEC value corresponding to ID 140	0 to 255
15F	DEC value corresponding to ID 141	0 to 255
160	DEC value corresponding to ID 142	0 to 255
161	DEC value corresponding to ID 143	0 to 255
162	DEC value corresponding to ID 144	0 to 255
163	DEC value corresponding to ID 145	0 to 255
164	DEC value corresponding to ID 146	0 to 255
165	DEC value corresponding to ID 147	0 to 255
166	DEC value corresponding to ID 148	0 to 255
167	DEC value corresponding to ID 149	0 to 255
168	DEC value corresponding to ID 150	0 to 255
169	DEC value corresponding to ID 151	0 to 255
16A	DEC value corresponding to ID 152	0 to 255
16B	DEC value corresponding to ID 153	0 to 255
16C	DEC value corresponding to ID 154	0 to 255
16D	DEC value corresponding to ID 155	0 to 255
16E	DEC value corresponding to ID 156	0 to 255
16F	DEC value corresponding to ID 157	0 to 255
170	DEC value corresponding to ID 158	0 to 255
171	DEC value corresponding to ID 159	0 to 255
172	DEC value corresponding to ID 160	0 to 255
173	DEC value corresponding to ID 161	0 to 255
174	DEC value corresponding to ID 162	0 to 255
175	DEC value corresponding to ID 163	0 to 255
176	DEC value corresponding to ID 164	0 to 255
177	DEC value corresponding to ID 165	0 to 255
178	DEC value corresponding to ID 166	0 to 255
179	DEC value corresponding to ID 167	0 to 255
17A	DEC value corresponding to ID 168	0 to 255
17B	DEC value corresponding to ID 169	0 to 255
17C	DEC value corresponding to ID 170	0 to 255
17D	DEC value corresponding to ID 171	0 to 255
17E	DEC value corresponding to ID 172	0 to 255
17F	DEC value corresponding to ID 173	0 to 255
180	DEC value corresponding to ID 174	0 to 255
181	DEC value corresponding to ID 175	0 to 255
182	DEC value corresponding to ID 176	0 to 255
183	DEC value corresponding to ID 177	0 to 255
184	DEC value corresponding to ID 178	0 to 255
185	DEC value corresponding to ID 179	0 to 255
186	DEC value corresponding to ID 180	0 to 255
187	DEC value corresponding to ID 181	0 to 255

A

Modbus (Hex)	Function	Description
188	DEC value corresponding to ID 182	0 to 255
189	DEC value corresponding to ID 183	0 to 255
18A	DEC value corresponding to ID 184	0 to 255
18B	DEC value corresponding to ID 185	0 to 255
18C	DEC value corresponding to ID 186	0 to 255
18D	DEC value corresponding to ID 187	0 to 255
18E	DEC value corresponding to ID 188	0 to 255
18F	DEC value corresponding to ID 189	0 to 255
190	DEC value corresponding to ID 190	0 to 255
191	DEC value corresponding to ID 191	0 to 255
192	DEC value corresponding to ID 192	0 to 255
193	DEC value corresponding to ID 193	0 to 255
194	DEC value corresponding to ID 194	0 to 255
195	DEC value corresponding to ID 195	0 to 255
196	DEC value corresponding to ID 196	0 to 255
197	DEC value corresponding to ID 197	0 to 255
198	DEC value corresponding to ID 198	0 to 255
199	DEC value corresponding to ID 199	0 to 255
19A	DEC value corresponding to ID 200	0 to 255
19B	DEC value corresponding to ID 201	0 to 255
19C	DEC value corresponding to ID 202	0 to 255
19D	DEC value corresponding to ID 203	0 to 255
19E	DEC value corresponding to ID 204	0 to 255
19F	DEC value corresponding to ID 205	0 to 255
1A0	DEC value corresponding to ID 206	0 to 255
1A1	DEC value corresponding to ID 207	0 to 255
1A2	DEC value corresponding to ID 208	0 to 255
1A3	DEC value corresponding to ID 209	0 to 255
1A4	DEC value corresponding to ID 210	0 to 255
1A5	DEC value corresponding to ID 211	0 to 255
1A6	DEC value corresponding to ID 212	0 to 255
1A7	DEC value corresponding to ID 213	0 to 255
1A8	DEC value corresponding to ID 214	0 to 255
1A9	DEC value corresponding to ID 215	0 to 255
1AA	DEC value corresponding to ID 216	0 to 255
1AB	DEC value corresponding to ID 217	0 to 255
1AC	DEC value corresponding to ID 218	0 to 255
1AD	DEC value corresponding to ID 219	0 to 255
1AE	DEC value corresponding to ID 220	0 to 255
1AF	DEC value corresponding to ID 221	0 to 255
1B0	DEC value corresponding to ID 222	0 to 255
1B1	DEC value corresponding to ID 223	0 to 255
1B2	DEC value corresponding to ID 224	0 to 255

Modbus (Hex)	Function	Description
1B3	DEC value corresponding to ID 225	0 to 255
1B4	DEC value corresponding to ID 226	0 to 255
1B5	DEC value corresponding to ID 227	0 to 255
1B6	DEC value corresponding to ID 228	0 to 255
1B7	DEC value corresponding to ID 229	0 to 255
1B8	DEC value corresponding to ID 230	0 to 255
1B9	DEC value corresponding to ID 231	0 to 255
1BA	DEC value corresponding to ID 232	0 to 255
1BB	DEC value corresponding to ID 233	0 to 255
1BC	DEC value corresponding to ID 234	0 to 255
1BD	DEC value corresponding to ID 235	0 to 255
1BE	DEC value corresponding to ID 236	0 to 255
1BF	DEC value corresponding to ID 237	0 to 255
1C0	DEC value corresponding to ID 238	0 to 255
1C1	DEC value corresponding to ID 239	0 to 255
1C2	DEC value corresponding to ID 240	0 to 255
1C3	DEC value corresponding to ID 241	0 to 255
1C4	DEC value corresponding to ID 242	0 to 255
1C5	DEC value corresponding to ID 243	0 to 255
1C6	DEC value corresponding to ID 244	0 to 255
1C7	DEC value corresponding to ID 245	0 to 255
1C8	DEC value corresponding to ID 246	0 to 255
1C9	DEC value corresponding to ID 247	0 to 255
1CA	DEC value corresponding to ID 248	0 to 255
1CB	DEC value corresponding to ID 249	0 to 255
1CC	DEC value corresponding to ID 250	0 to 255
1CD	DEC value corresponding to ID 251	0 to 255
1CE	DEC value corresponding to ID 252	0 to 255
1CF	DEC value corresponding to ID 253	0 to 255
1D0	DEC value corresponding to ID 254	0 to 255
1D1	DEC value corresponding to ID 255	0 to 255

A

2. Fill in the write request to 0xC8 - 0xCE.

Modbus (Hex)	Write / Read request	Write
C8	Function code	508
C9	Version number	0
CA	Tool 1 / Tool 2	0: Tool 1; 1: Tool 2
CB	Conversion table	0: bit DO conversion table 1: bit DI conversion table 2: parameter DO conversion table 4: screw progress DO conversion table 6: sequence DO conversion table
CC	Reserved	-
CD	Reserved	-
CE	Request to send command	1 (fill in lastly)

3. Then check whether the writing is successful from the returned status in 0xCF - 0xD1.

Modbus (Hex)	Returned status	Description
CF	Function code	508
D0	Returned status	1: OK; 2: NOK
D1	Error code	Error code

If successful, the returned status (0xD0) is read as 1.

If failed, the returned status (0xD1) is read as 2. The error codes are as follows:

Code	Error description	Description
1	Tool 1 / Tool 2	Must be 0 or 1
2	Conversion table	Must be 0, 1, 2, 4, or 6

#509 Write the default torque unit

Content description:

Use function code #509 to set the default torque unit of the controller.

Handshake signal description:

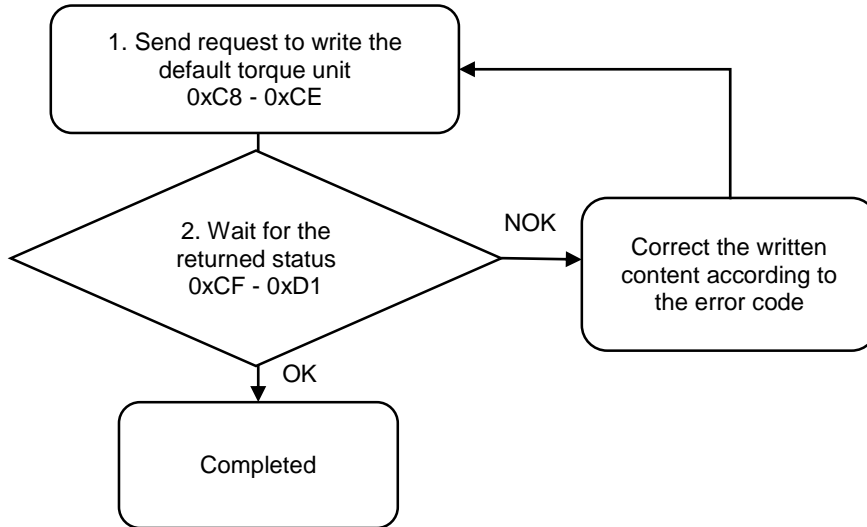

1. Fill in the write request to 0xC8 - 0xCE.

Modbus (Hex)	Write / Read request	Write
C8	Function code	509
C9	Version number	0
CA	Default torque unit	0: Nm 1: kgf-cm 2: lbf-ft 3: lbf-in
CB	Reserved	-
CC	Reserved	-
CD	Reserved	-
CE	Request to send command	1 (fill in lastly)

2. Then check whether the writing is successful from the returned status in 0xCF - 0xD1.

Modbus (Hex)	Returned status	Description
CF	Function code	509
D0	Returned status	1: OK; 2: NOK
D1	Error code	Error code

If successful, the returned status (0xD0) is read as 1.

If failed, the returned status (0xD1) is read as 2. The error code is as follows:

Code	Error description	Description
1	Default torque unit	Exceeds the range of 0 to 3

A

#510 Write the default tool start condition

Content description:

Use function code #510 to set the default tool start condition.

Handshake signal description:

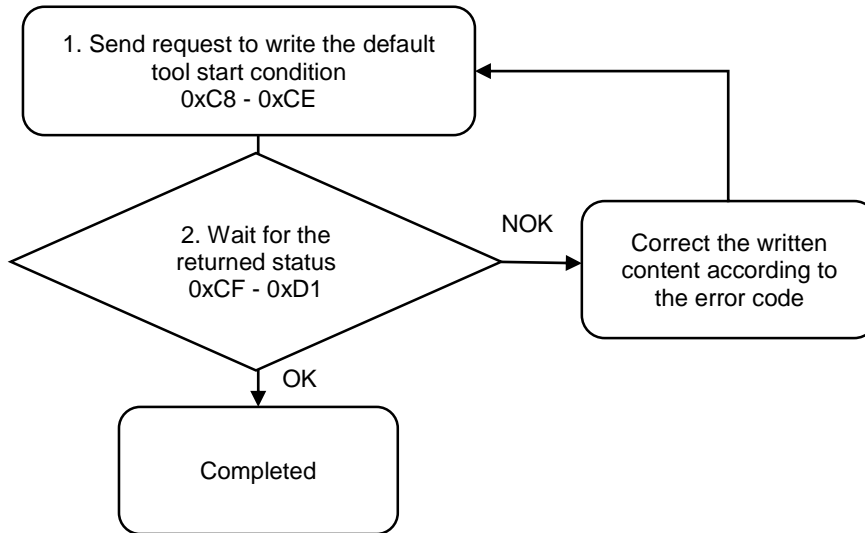

1. Fill in the write request to 0xC8 - 0xCE.

Modbus (Hex)	Write / Read request	Write
C8	Function code	510
C9	Version number	0
CA	Default tool start condition	0: push start 1: DI 2: lever start 3: push start or lever start 4: push start and lever start
CB - CD	Reserved	-
CE	Request to send command	1 (fill in lastly)

2. Then check whether the writing is successful from the returned status in 0xCF - 0xD1.

Modbus (Hex)	Returned status	Description
CF	Function code	510
D0	Returned status	1: OK; 2: NOK
D1	Error code	Error code

If successful, the returned status (0xD0) is read as 1.

If failed, the returned status (0xD1) is read as 2. The error code is as follows:

Code	Error description	Description
1	Start condition	Exceeds the range of 0 to 4

#550 Read the Ethernet settings

Content description:

Use function code #550 to read the Ethernet IP settings.

Handshake signal description:

A

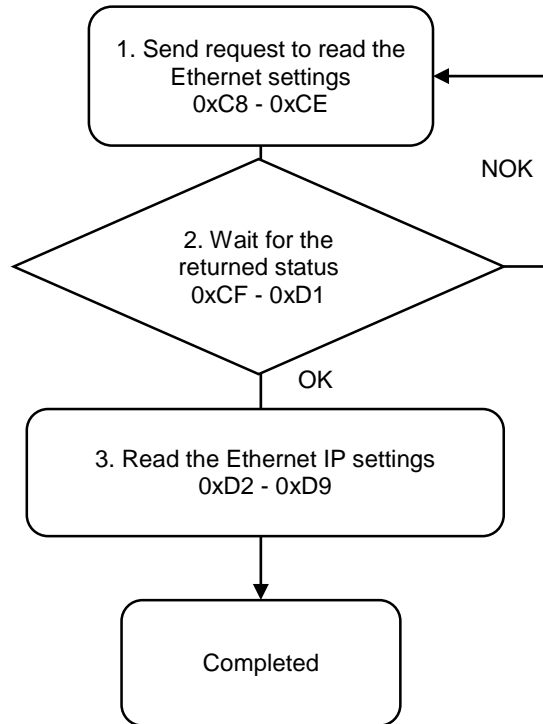

1. Fill in the read request to 0xC8 - 0xCE.

Modbus (Hex)	Write / Read request	Write
C8	Function code	550
C9	Version number	0
CA	Reserved	-
CB	Reserved	-
CC	Reserved	-
CD	Reserved	-
CE	Request to send command	1 (fill in lastly)

2. Check whether the reading is successful from the returned status in 0xCF - 0xD1.

Modbus (Hex)	Returned status	Description
CF	Function code	550
D0	Returned status	1: OK; 2: NOK
D1	Error code	Error code

If successful, the returned status (0xD0) is read as 1.

If failed, the returned status (0xD0) is read as 2.

3. Obtain the IP and subnet mask address from 0xD2 - 0xD9.

Modbus (Hex)	Function	Description
D2	IP1 address	Default: 192
D3	IP2 address	Default: 168
D4	IP3 address	Default: 1
D5	IP4 address	Default: 11
D6	Subnet mask 1	Default: 255
D7	Subnet mask 2	Default: 255
D8	Subnet mask 3	Default: 255
D9	Subnet mask 4	Default: 0

#551 Read the page permissions

Content description:

Use function code #551 to read the page permissions for different users to access and edit.

Handshake signal description:

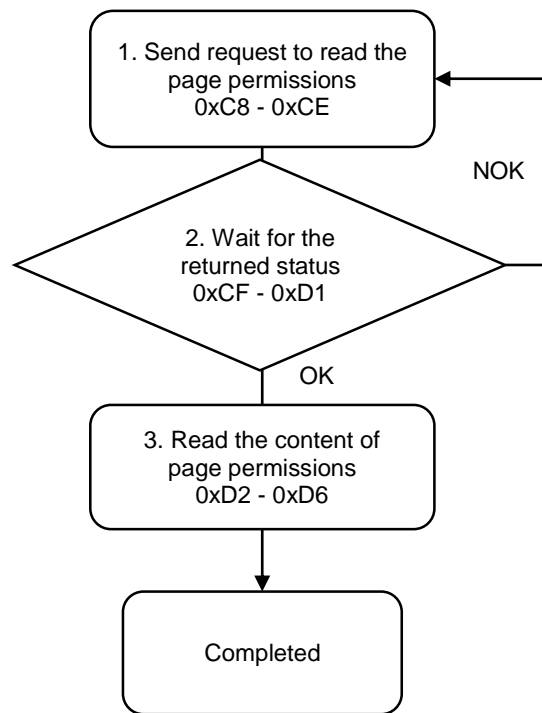

1. Fill in the read request to 0xC8 - 0xCE.

Modbus (Hex)	Write / Read request	Write
C8	Function code	551
C9	Version number	0
CA	Reserved	-
CB	Reserved	-
CC	Reserved	-
CD	Reserved	-
CE	Request to send command	1 (fill in lastly)

- Check whether the reading is successful from the returned status in 0xCF - 0xD1.

Modbus (Hex)	Returned status	Description
CF	Function code	551
D0	Returned status	1: OK; 2: NOK
D1	Error code	Error code

If successful, the returned status (0xD0) is read as 1.

If failed, the returned status (0xD0) is read as 2.

- Obtain the page permissions settings from 0xD2 - 0xD6.

Modbus (Hex)	Function	Description
D2	User1 page permissions	BIT0: Parameters BIT1: Sequence BIT2: Sources BIT3: Controller BIT4: Tool BIT5: operation for screw progress BIT6: Clear the production report entries Bit7: Clear the error and warning report entries
D3	User2 page permissions	
D4	User3 page permissions	
D5	User4 page permissions	
D6	User5 page permissions	

#552 Read the firmware version

Content description:

Use function code #552 to read the firmware version of the servo screwdriver controller.

Handshake signal description:

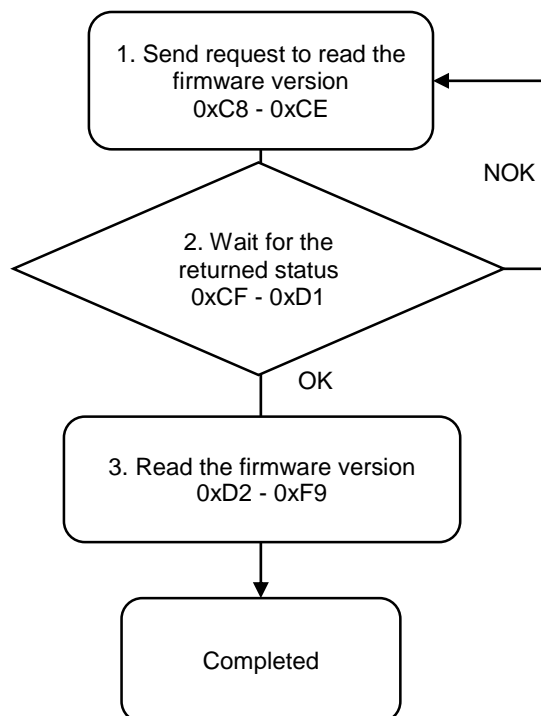

- Fill in the read request to 0xC8 - 0xCE.

A

A

Modbus (Hex)	Write / Read request	Write
C8	Function code	552
C9	Version number	0
CA - CD	Reserved	-
CE	Request to send command	1 (fill in lastly)

2. Check whether the reading is successful from the returned status in 0xCF - 0xD1.

Modbus (Hex)	Returned status	Description
CF	Function code	552
D0	Returned status	1: OK; 2: NOK
D1	Error code	Error code

If successful, the returned status (0xD0) is read as 1.

If failed, the returned status (0xD0) is read as 2.

3. Obtain the controller firmware version from 0xD2 - 0xF9.

Modbus (Hex)	Function	Description
D2 - F9	Version number (40 words)	ASCII code

#553 Read the DI/DO functions

Content description:

Use function code #553 to read the DI/DO functions.

Handshake signal description:

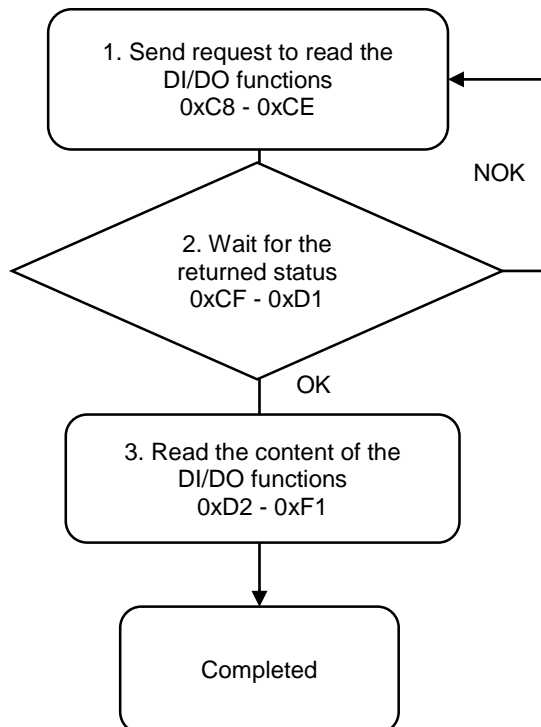

1. Fill in the read request to 0xC8 - 0xCE.

Modbus (Hex)	Write / Read request	Write
C8	Function code	553
C9	Version number	0
CA	Reserved	-
CB	Reserved	-
CC	Reserved	-
CD	Reserved	-
CE	Request to send command	1 (fill in lastly)

2. Check whether the reading is successful from the returned status in 0xCF - 0xD1.

Modbus (Hex)	Returned status	Description
CF	Function code	553
D0	Returned status	1: OK; 2: NOK
D1	Error code	Error code

If successful, the returned status (0xD0) is read as 1.

If failed, the returned status (0xD0) is read as 2.

3. Obtain the content of the DI/DO functions from 0xD2 - 0xF1. (NO: normally open; NC: normally closed)

Modbus (Hex)	Function	Description
D2	DO1 NO / NC	0: NO; 1: NC
D3	DO2 NO / NC	0: NO; 1: NC
D4	DO3 NO / NC	0: NO; 1: NC
D5	DO4 NO / NC	0: NO; 1: NC
D6	DO5 NO / NC	0: NO; 1: NC
D7	DO6 NO / NC	0: NO; 1: NC
D8	DO7 NO / NC	0: NO; 1: NC
D9	DO8 NO / NC	0: NO; 1: NC
DA	DO1 function code	0: not in use 1: ready 2: running 3: tightening OK 4: tightening NOK 5: loosening OK 6: loosening NOK 7: total screw quantity reached 8 to 15: reserved 16 to 23: bit ID output (Bit 1 - 8) 24 to 31: parameter ID output (Bit 1 - 8) 32 to 39: screw progress output (Bit 1 - 8) 40 to 47: sequence ID output (Bit 1 - 8)
DB	DO2 function code	Same as above
DC	DO3 function code	Same as above
DD	DO4 function code	Same as above
DE	DO5 function code	Same as above

A

Modbus (Hex)	Function	Description
DF	DO6 function code	Same as above
E0	DO7 function code	Same as above
E1	DO8 function code	Same as above
E2	DI1 NO / NC	0: NO; 1: NC
E3	DI2 NO / NC	0: NO; 1: NC
E4	DI3 NO / NC	0: NO; 1: NC
E5	DI4 NO / NC	0: NO; 1: NC
E6	DI5 NO / NC	0: NO; 1: NC
E7	DI6 NO / NC	0: NO; 1: NC
E8	DI7 NO / NC	0: NO; 1: NC
E9	DI8 NO / NC	0: NO; 1: NC
EA	DI1 function code	0: not in use 1: start tightening 2: start loosening 3: emergency stop 4: clear error 5: reset total screw quantity 6: next step 7: previous step 8: start tightening (pulse signal) 9: start loosening (pulse signal) 10: start tightening (dual-tool) 11: start loosening (dual-tool) 12 to 15: reserved 16 to 23: parameter ID input (Bit 1 - 8) 24 to 31: screw progress input (Bit 1 - 8) 32 to 39: sequence ID input (Bit 1 - 8) 40 to 47: bit ID input (Bit 1 - 8)
EB	DI2 function code	Same as above
EC	DI3 function code	Same as above
ED	DI4 function code	Same as above
EE	DI5 function code	Same as above
EF	DI6 function code	Same as above
F0	DI7 function code	Same as above
F1	DI8 function code	Same as above

#554 Read the DI/DO conversion table

Content description:

Use function code #554 to read the DI/DO conversion tables information.

- A. Read the bit DO conversion table.
- B. Read the bit DI conversion table.
- C. Read the parameter DO conversion table.
- D. Read the screw progress DO conversion table.
- E. Read the sequence DO conversion table.



Handshake signal description:

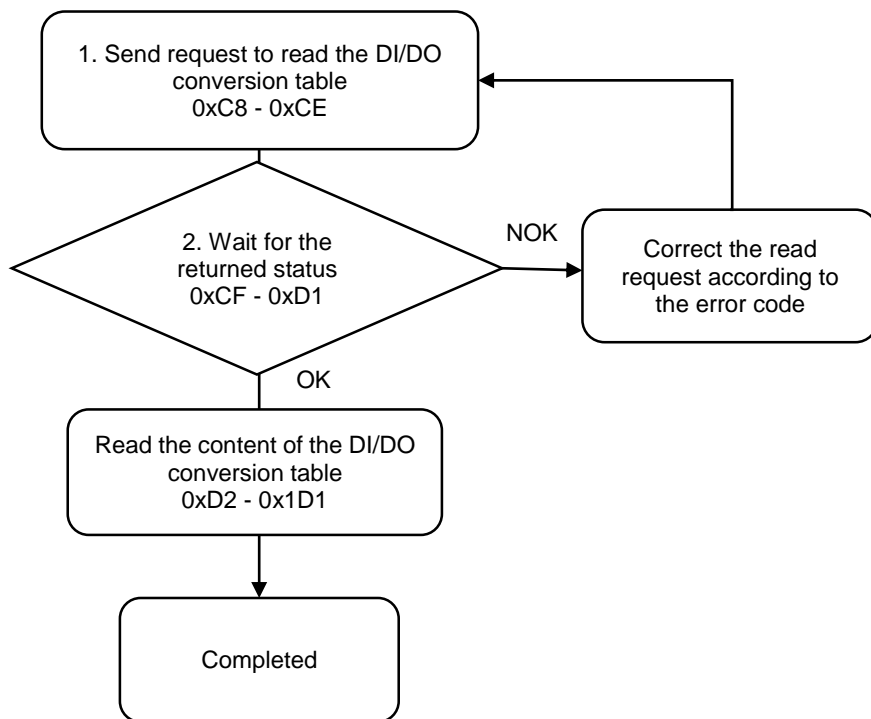

1. Fill in the read request to 0xC8 - 0xCE.

Modbus (Hex)	Write / Read request	Write
C8	Function code	554
C9	Version number	0
CA	Tool 1 / Tool 2	0: Tool 1; 1: Tool 2
CB	Conversion table	0: bit DO conversion table 1: bit DI conversion table 2: parameter DO conversion table 4: screw progress DO conversion table 6: sequence DO conversion table
CC	Reserved	-
CD	Reserved	-
CE	Request to send command	1 (fill in lastly)

2. Check whether the reading is successful from the returned status in 0xCF - 0xD1.

Modbus (Hex)	Returned status	Description
CF	Function code	554
D0	Returned status	1: OK; 2: NOK
D1	Error code	Error code

If successful, the returned status (0xD0) is read as 1.

If failed, the returned status (0xD0) is read as 2. The error codes are as follows:

Code	Error description	Description
1	Tool 1 / Tool 2	Must be 0 or 1
2	Conversion table	Must be 0, 1, 2, 4, or 6

3. Obtain the content of the DI/DO conversion table from 0xD2 - 0x1D1.

Modbus (Hex)	Function	Description
D2	DEC value corresponding to ID 0	0 to 255
D3	DEC value corresponding to ID 1	0 to 255
D4	DEC value corresponding to ID 2	0 to 255
D5	DEC value corresponding to ID 3	0 to 255
D6	DEC value corresponding to ID 4	0 to 255
D7	DEC value corresponding to ID 5	0 to 255
D8	DEC value corresponding to ID 6	0 to 255
D9	DEC value corresponding to ID 7	0 to 255
DA	DEC value corresponding to ID 8	0 to 255
DB	DEC value corresponding to ID 9	0 to 255
DC	DEC value corresponding to ID 10	0 to 255
DD	DEC value corresponding to ID 11	0 to 255
DE	DEC value corresponding to ID 12	0 to 255
DF	DEC value corresponding to ID 13	0 to 255
E0	DEC value corresponding to ID 14	0 to 255
E1	DEC value corresponding to ID 15	0 to 255
E2	DEC value corresponding to ID 16	0 to 255
E3	DEC value corresponding to ID 17	0 to 255
E4	DEC value corresponding to ID 18	0 to 255
E5	DEC value corresponding to ID 19	0 to 255
E6	DEC value corresponding to ID 20	0 to 255
E7	DEC value corresponding to ID 21	0 to 255
E8	DEC value corresponding to ID 22	0 to 255
E9	DEC value corresponding to ID 23	0 to 255
EA	DEC value corresponding to ID 24	0 to 255
EB	DEC value corresponding to ID 25	0 to 255
EC	DEC value corresponding to ID 26	0 to 255
ED	DEC value corresponding to ID 27	0 to 255
EE	DEC value corresponding to ID 28	0 to 255
EF	DEC value corresponding to ID 29	0 to 255

Modbus (Hex)	Function	Description
F0	DEC value corresponding to ID 30	0 to 255
F1	DEC value corresponding to ID 31	0 to 255
F2	DEC value corresponding to ID 32	0 to 255
F3	DEC value corresponding to ID 33	0 to 255
F4	DEC value corresponding to ID 34	0 to 255
F5	DEC value corresponding to ID 35	0 to 255
F6	DEC value corresponding to ID 36	0 to 255
F7	DEC value corresponding to ID 37	0 to 255
F8	DEC value corresponding to ID 38	0 to 255
F9	DEC value corresponding to ID 39	0 to 255
FA	DEC value corresponding to ID 40	0 to 255
FB	DEC value corresponding to ID 41	0 to 255
FC	DEC value corresponding to ID 42	0 to 255
FD	DEC value corresponding to ID 43	0 to 255
FE	DEC value corresponding to ID 44	0 to 255
FF	DEC value corresponding to ID 45	0 to 255
100	DEC value corresponding to ID 46	0 to 255
101	DEC value corresponding to ID 47	0 to 255
102	DEC value corresponding to ID 48	0 to 255
103	DEC value corresponding to ID 49	0 to 255
104	DEC value corresponding to ID 50	0 to 255
105	DEC value corresponding to ID 51	0 to 255
106	DEC value corresponding to ID 52	0 to 255
107	DEC value corresponding to ID 53	0 to 255
108	DEC value corresponding to ID 54	0 to 255
109	DEC value corresponding to ID 55	0 to 255
10A	DEC value corresponding to ID 56	0 to 255
10B	DEC value corresponding to ID 57	0 to 255
10C	DEC value corresponding to ID 58	0 to 255
10D	DEC value corresponding to ID 59	0 to 255
10E	DEC value corresponding to ID 60	0 to 255
10F	DEC value corresponding to ID 61	0 to 255
110	DEC value corresponding to ID 62	0 to 255
111	DEC value corresponding to ID 63	0 to 255
112	DEC value corresponding to ID 64	0 to 255
113	DEC value corresponding to ID 65	0 to 255
114	DEC value corresponding to ID 66	0 to 255
115	DEC value corresponding to ID 67	0 to 255
116	DEC value corresponding to ID 68	0 to 255
117	DEC value corresponding to ID 69	0 to 255
118	DEC value corresponding to ID 70	0 to 255
119	DEC value corresponding to ID 71	0 to 255

A

Modbus (Hex)	Function	Description
11A	DEC value corresponding to ID 72	0 to 255
11B	DEC value corresponding to ID 73	0 to 255
11C	DEC value corresponding to ID 74	0 to 255
11D	DEC value corresponding to ID 75	0 to 255
11E	DEC value corresponding to ID 76	0 to 255
11F	DEC value corresponding to ID 77	0 to 255
120	DEC value corresponding to ID 78	0 to 255
121	DEC value corresponding to ID 79	0 to 255
122	DEC value corresponding to ID 80	0 to 255
123	DEC value corresponding to ID 81	0 to 255
124	DEC value corresponding to ID 82	0 to 255
125	DEC value corresponding to ID 83	0 to 255
126	DEC value corresponding to ID 84	0 to 255
127	DEC value corresponding to ID 85	0 to 255
128	DEC value corresponding to ID 86	0 to 255
129	DEC value corresponding to ID 87	0 to 255
12A	DEC value corresponding to ID 88	0 to 255
12B	DEC value corresponding to ID 89	0 to 255
12C	DEC value corresponding to ID 90	0 to 255
12D	DEC value corresponding to ID 91	0 to 255
12E	DEC value corresponding to ID 92	0 to 255
12F	DEC value corresponding to ID 93	0 to 255
130	DEC value corresponding to ID 94	0 to 255
131	DEC value corresponding to ID 95	0 to 255
132	DEC value corresponding to ID 96	0 to 255
133	DEC value corresponding to ID 97	0 to 255
134	DEC value corresponding to ID 98	0 to 255
135	DEC value corresponding to ID 99	0 to 255
136	DEC value corresponding to ID 100	0 to 255
137	DEC value corresponding to ID 101	0 to 255
138	DEC value corresponding to ID 102	0 to 255
139	DEC value corresponding to ID 103	0 to 255
13A	DEC value corresponding to ID 104	0 to 255
13B	DEC value corresponding to ID 105	0 to 255
13C	DEC value corresponding to ID 106	0 to 255
13D	DEC value corresponding to ID 107	0 to 255
13E	DEC value corresponding to ID 108	0 to 255
13F	DEC value corresponding to ID 109	0 to 255
140	DEC value corresponding to ID 110	0 to 255
141	DEC value corresponding to ID 111	0 to 255
142	DEC value corresponding to ID 112	0 to 255
143	DEC value corresponding to ID 113	0 to 255
144	DEC value corresponding to ID 114	0 to 255

Modbus (Hex)	Function	Description
145	DEC value corresponding to ID 115	0 to 255
146	DEC value corresponding to ID 116	0 to 255
147	DEC value corresponding to ID 117	0 to 255
148	DEC value corresponding to ID 118	0 to 255
149	DEC value corresponding to ID 119	0 to 255
14A	DEC value corresponding to ID 120	0 to 255
14B	DEC value corresponding to ID 121	0 to 255
14C	DEC value corresponding to ID 122	0 to 255
14D	DEC value corresponding to ID 123	0 to 255
14E	DEC value corresponding to ID 124	0 to 255
14F	DEC value corresponding to ID 125	0 to 255
150	DEC value corresponding to ID 126	0 to 255
151	DEC value corresponding to ID 127	0 to 255
152	DEC value corresponding to ID 128	0 to 255
153	DEC value corresponding to ID 129	0 to 255
154	DEC value corresponding to ID 130	0 to 255
155	DEC value corresponding to ID 131	0 to 255
156	DEC value corresponding to ID 132	0 to 255
157	DEC value corresponding to ID 133	0 to 255
158	DEC value corresponding to ID 134	0 to 255
159	DEC value corresponding to ID 135	0 to 255
15A	DEC value corresponding to ID 136	0 to 255
15B	DEC value corresponding to ID 137	0 to 255
15C	DEC value corresponding to ID 138	0 to 255
15D	DEC value corresponding to ID 139	0 to 255
15E	DEC value corresponding to ID 140	0 to 255
15F	DEC value corresponding to ID 141	0 to 255
160	DEC value corresponding to ID 142	0 to 255
161	DEC value corresponding to ID 143	0 to 255
162	DEC value corresponding to ID 144	0 to 255
163	DEC value corresponding to ID 145	0 to 255
164	DEC value corresponding to ID 146	0 to 255
165	DEC value corresponding to ID 147	0 to 255
166	DEC value corresponding to ID 148	0 to 255
167	DEC value corresponding to ID 149	0 to 255
168	DEC value corresponding to ID 150	0 to 255
169	DEC value corresponding to ID 151	0 to 255
16A	DEC value corresponding to ID 152	0 to 255
16B	DEC value corresponding to ID 153	0 to 255
16C	DEC value corresponding to ID 154	0 to 255
16D	DEC value corresponding to ID 155	0 to 255
16E	DEC value corresponding to ID 156	0 to 255

A

Modbus (Hex)	Function	Description
16F	DEC value corresponding to ID 157	0 to 255
170	DEC value corresponding to ID 158	0 to 255
171	DEC value corresponding to ID 159	0 to 255
172	DEC value corresponding to ID 160	0 to 255
173	DEC value corresponding to ID 161	0 to 255
174	DEC value corresponding to ID 162	0 to 255
175	DEC value corresponding to ID 163	0 to 255
176	DEC value corresponding to ID 164	0 to 255
177	DEC value corresponding to ID 165	0 to 255
178	DEC value corresponding to ID 166	0 to 255
179	DEC value corresponding to ID 167	0 to 255
17A	DEC value corresponding to ID 168	0 to 255
17B	DEC value corresponding to ID 169	0 to 255
17C	DEC value corresponding to ID 170	0 to 255
17D	DEC value corresponding to ID 171	0 to 255
17E	DEC value corresponding to ID 172	0 to 255
17F	DEC value corresponding to ID 173	0 to 255
180	DEC value corresponding to ID 174	0 to 255
181	DEC value corresponding to ID 175	0 to 255
182	DEC value corresponding to ID 176	0 to 255
183	DEC value corresponding to ID 177	0 to 255
184	DEC value corresponding to ID 178	0 to 255
185	DEC value corresponding to ID 179	0 to 255
186	DEC value corresponding to ID 180	0 to 255
187	DEC value corresponding to ID 181	0 to 255
188	DEC value corresponding to ID 182	0 to 255
189	DEC value corresponding to ID 183	0 to 255
18A	DEC value corresponding to ID 184	0 to 255
18B	DEC value corresponding to ID 185	0 to 255
18C	DEC value corresponding to ID 186	0 to 255
18D	DEC value corresponding to ID 187	0 to 255
18E	DEC value corresponding to ID 188	0 to 255
18F	DEC value corresponding to ID 189	0 to 255
190	DEC value corresponding to ID 190	0 to 255
191	DEC value corresponding to ID 191	0 to 255
192	DEC value corresponding to ID 192	0 to 255
193	DEC value corresponding to ID 193	0 to 255
194	DEC value corresponding to ID 194	0 to 255
195	DEC value corresponding to ID 195	0 to 255
196	DEC value corresponding to ID 196	0 to 255
197	DEC value corresponding to ID 197	0 to 255
198	DEC value corresponding to ID 198	0 to 255
199	DEC value corresponding to ID 199	0 to 255

Modbus (Hex)	Function	Description
19A	DEC value corresponding to ID 200	0 to 255
19B	DEC value corresponding to ID 201	0 to 255
19C	DEC value corresponding to ID 202	0 to 255
19D	DEC value corresponding to ID 203	0 to 255
19E	DEC value corresponding to ID 204	0 to 255
19F	DEC value corresponding to ID 205	0 to 255
1A0	DEC value corresponding to ID 206	0 to 255
1A1	DEC value corresponding to ID 207	0 to 255
1A2	DEC value corresponding to ID 208	0 to 255
1A3	DEC value corresponding to ID 209	0 to 255
1A4	DEC value corresponding to ID 210	0 to 255
1A5	DEC value corresponding to ID 211	0 to 255
1A6	DEC value corresponding to ID 212	0 to 255
1A7	DEC value corresponding to ID 213	0 to 255
1A8	DEC value corresponding to ID 214	0 to 255
1A9	DEC value corresponding to ID 215	0 to 255
1AA	DEC value corresponding to ID 216	0 to 255
1AB	DEC value corresponding to ID 217	0 to 255
1AC	DEC value corresponding to ID 218	0 to 255
1AD	DEC value corresponding to ID 219	0 to 255
1AE	DEC value corresponding to ID 220	0 to 255
1AF	DEC value corresponding to ID 221	0 to 255
1B0	DEC value corresponding to ID 222	0 to 255
1B1	DEC value corresponding to ID 223	0 to 255
1B2	DEC value corresponding to ID 224	0 to 255
1B3	DEC value corresponding to ID 225	0 to 255
1B4	DEC value corresponding to ID 226	0 to 255
1B5	DEC value corresponding to ID 227	0 to 255
1B6	DEC value corresponding to ID 228	0 to 255
1B7	DEC value corresponding to ID 229	0 to 255
1B8	DEC value corresponding to ID 230	0 to 255
1B9	DEC value corresponding to ID 231	0 to 255
1BA	DEC value corresponding to ID 232	0 to 255
1BB	DEC value corresponding to ID 233	0 to 255
1BC	DEC value corresponding to ID 234	0 to 255
1BD	DEC value corresponding to ID 235	0 to 255
1BE	DEC value corresponding to ID 236	0 to 255
1BF	DEC value corresponding to ID 237	0 to 255
1C0	DEC value corresponding to ID 238	0 to 255
1C1	DEC value corresponding to ID 239	0 to 255
1C2	DEC value corresponding to ID 240	0 to 255
1C3	DEC value corresponding to ID 241	0 to 255

A

A

Modbus (Hex)	Function	Description
1C4	DEC value corresponding to ID 242	0 to 255
1C5	DEC value corresponding to ID 243	0 to 255
1C6	DEC value corresponding to ID 244	0 to 255
1C7	DEC value corresponding to ID 245	0 to 255
1C8	DEC value corresponding to ID 246	0 to 255
1C9	DEC value corresponding to ID 247	0 to 255
1CA	DEC value corresponding to ID 248	0 to 255
1CB	DEC value corresponding to ID 249	0 to 255
1CC	DEC value corresponding to ID 250	0 to 255
1CD	DEC value corresponding to ID 251	0 to 255
1CE	DEC value corresponding to ID 252	0 to 255
1CF	DEC value corresponding to ID 253	0 to 255
1D0	DEC value corresponding to ID 254	0 to 255
1D1	DEC value corresponding to ID 255	0 to 255

#555 Read the default torque unit

Content description:

Use function code #555 to read the default torque unit of the controller.

Handshake signal description:

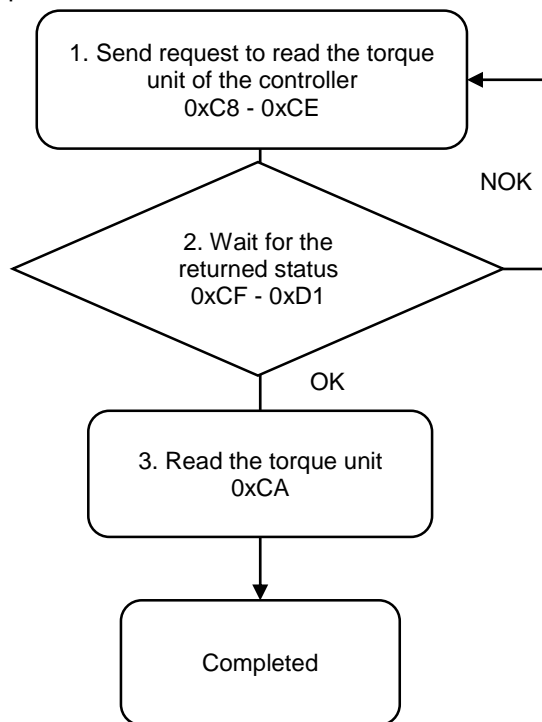



1. Fill in the read request to 0xC8 - 0xCE.

Modbus (Hex)	Write / Read request	Write
C8	Function code	555
C9	Version number	0
CA - CD	Reserved	-
CE	Request to send command	1 (fill in lastly)

2. Check whether the reading is successful from the returned status in 0xCF - 0xD1.

Modbus (Hex)	Returned status	Description
CF	Function code	555
D0	Returned status	1: OK; 2: NOK
D1	Error code	Error code

If successful, the returned status (0xD0) is read as 1.

If failed, the returned status (0xD0) is read as 2.

3. Obtain the information from 0xCA.

Modbus (Hex)	Write / Read request	Read
CA	Default torque unit	0: Nm 1: kgf-cm 2: lbf-ft 3: lbf-in

#556 Read the default tool start condition

Content description:

Use function code #556 to read the default tool start condition.

Handshake signal description:

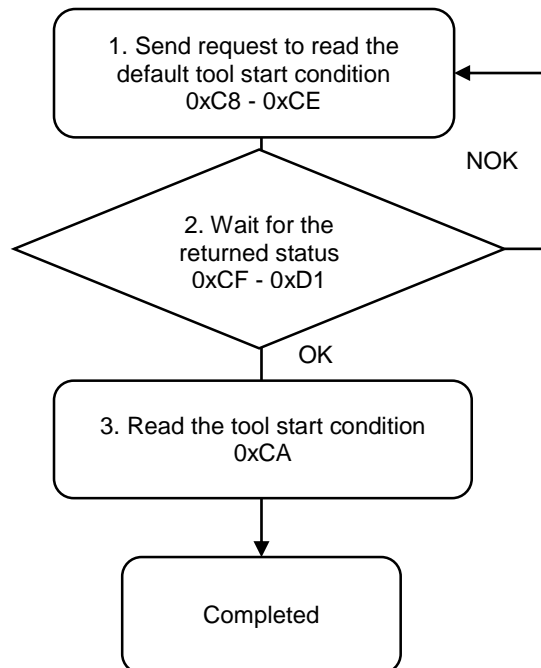

1. Fill in the read request to 0xC8 - 0xCE.

Modbus (Hex)	Write / Read request	Write
C8	Function code	556
C9	Version number	0
CA	Reserved	-
CB	Reserved	-
CC	Reserved	-
CD	Reserved	-
CE	Request to send command	1 (fill in lastly)

2. Check whether the reading is successful from the returned status in 0xCF - 0xD1.

Modbus (Hex)	Returned status	Description
CF	Function code	556
D0	Returned status	1: OK; 2: NOK
D1	Error code	Error code

If successful, the returned status (0xD0) is read as 1.

If failed, the returned status (0xD0) is read as 2.

3. Obtain the information from 0xCA.

Modbus (Hex)	Write / Read request	Read
CA	Default tool start condition	0: push start 1: DI 2: lever start 3: push start or lever start 4: push start and lever start

A.3.6 Tool operations

Tool			
Function code	Function name	Function code	Function name
#600	Write to activate the tool	#650	Read the tool information
#601	Write to enable service reminder	#651	Read the lever start level
#602	Write the lever start level	#652	Read the push start level
#603	Write the push start level	#653	Read the work light brightness
#604	Write the work light brightness	#654	Reserved
#605	Reserved	#655	Read the LED light settings
#606	Write the LED light settings	#656	Read the tool calibration
#607	Write the tool calibration	-	-

A

#600 Write to activate the tool

Content description:

Use function code #600 to activate Tool 1 and Tool 2.

Handshake signal description:

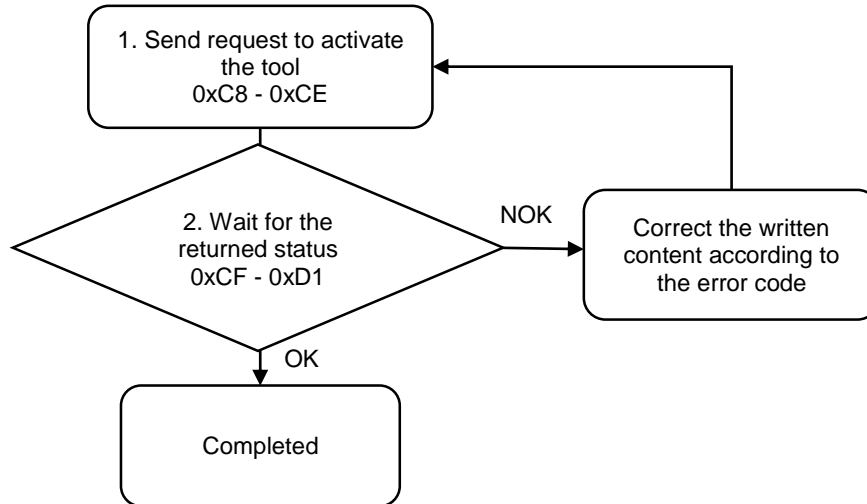

1. Fill in the write request to 0xC8 - 0xCE.

Modbus (Hex)	Write / Read request	Write
C8	Function code	600
C9	Version number	0
CA	Tool 1 / Tool 2	0: Tool 1; 1: Tool 2
CB	On / Off	0: off; 1: on
CC	Reserved	-
CD	Reserved	-
CE	Request to send command	1 (fill in lastly)

2. Then check whether the writing is successful from the returned status in 0xCF - 0xD1.

Modbus (Hex)	Returned status	Description
CF	Function code	600
D0	Returned status	1: OK; 2: NOK
D1	Error code	Error code

If successful, the returned status (0xD0) is read as 1.

If failed, the returned status (0xD1) is read as 2. The error codes are as follows:

Code	Error description	Description
1	Tool 2	Must be 1
2	On / Off	Must be 0 or 1

#601 Write to enable service reminder

Content description:

Use function code #601 to turn on or off the tool service reminder.

Handshake signal description:

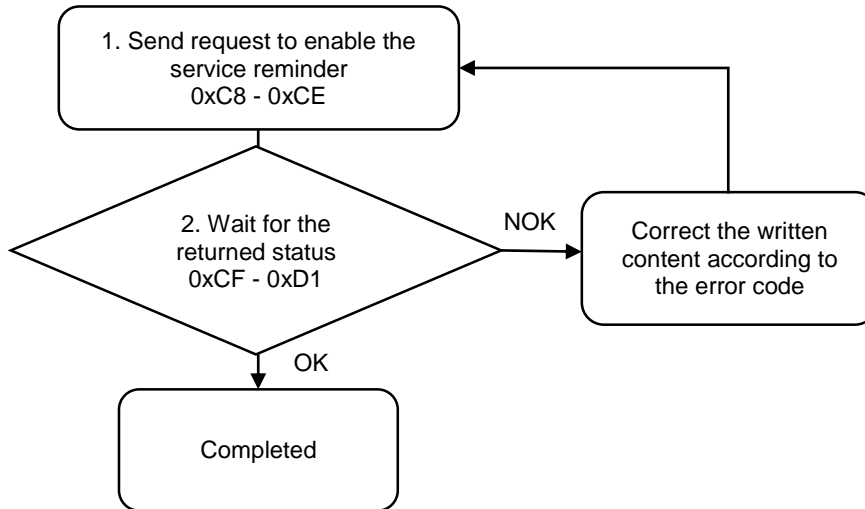

1. Fill in the write request to 0xC8 - 0xCE.

Modbus (Hex)	Write / Read request	Write
C8	Function code	601
C9	Version number	0
CA	Tool 1 / Tool 2	0: Tool 1; 1: Tool 2
CB	On / Off	0: off; 1: on
CC	Reserved	-
CD	Reserved	-
CE	Request to send command	1 (fill in lastly)

2. Then check whether the writing is successful from the returned status in 0xCF - 0xD1.

Modbus (Hex)	Returned status	Description
CF	Function code	601
D0	Returned status	1: OK; 2: NOK
D1	Error code	Error code

If successful, the returned status (0xD0) is read as 1.

If failed, the returned status (0xD1) is read as 2. The error codes are as follows:

Code	Error description	Description
1	Tool 1 / Tool 2	Must be 0 or 1
2	On / Off	Must be 0 or 1

A

#602 Write the lever start level

Content description:

Use function code #602 to set the lever start level of the tool.

Handshake signal description:

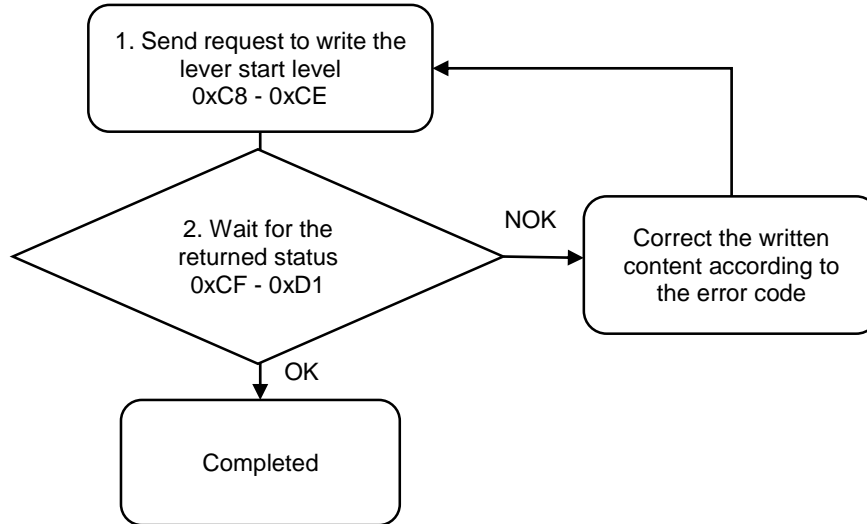

1. Fill in the write request to 0xC8 - 0xCE.

Modbus (Hex)	Write / Read request	Write
C8	Function code	602
C9	Version number	0
CA	Tool 1 / Tool 2	0: Tool 1; 1: Tool 2
CB	ON threshold level	0 to 4095
CC	Off threshold level	0 to 4095
CD	Reserved	-
CE	Request to send command	1 (fill in lastly)

2. Then check whether the writing is successful from the returned status in 0xCF - 0xD1.

Modbus (Hex)	Returned status	Description
CF	Function code	602
D0	Returned status	1: OK; 2: NOK
D1	Error code	Error code

If successful, the returned status (0xD0) is read as 1.

If failed, the returned status (0xD1) is read as 2. The error codes are as follows:

Code	Error description	Description
1	Tool 1 / Tool 2	Must be 0 or 1
2	Threshold level	Exceeds the range of 0 to 4095

#603 Write the push start level

Content description:

Use function code #603 to set the push start level of the tool.

Handshake signal description:

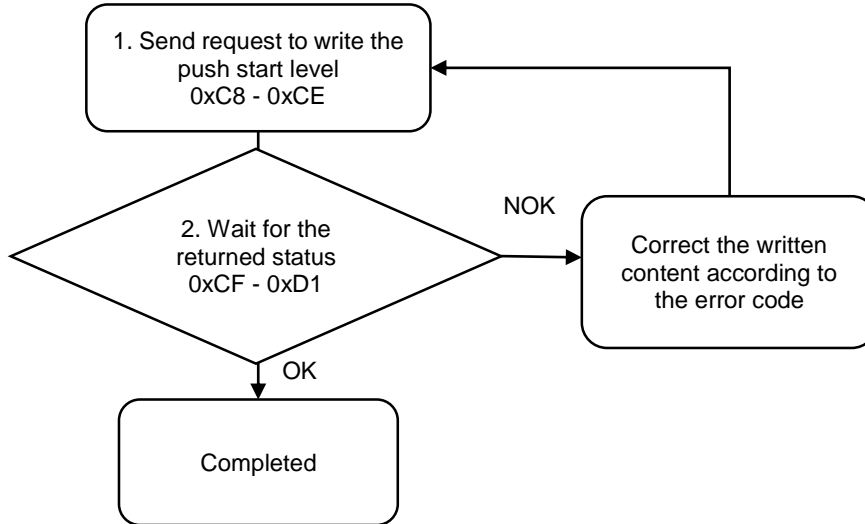

A

1. Fill in the write request to 0xC8 - 0xCE.

Modbus (Hex)	Write / Read request	Write
C8	Function code	603
C9	Version number	0
CA	Tool 1 / Tool 2	0: Tool 1; 1: Tool 2
CB	ON threshold level	0 to 4095
CC	Off threshold level	0 to 4095
CD	Reserved	-
CE	Request to send command	1 (fill in lastly)

2. Then check whether the writing is successful from the returned status in 0xCF - 0xD1.

Modbus (Hex)	Returned status	Description
CF	Function code	603
D0	Returned status	1: OK; 2: NOK
D1	Error code	Error code

If successful, the returned status (0xD0) is read as 1.

If failed, the returned status (0xD1) is read as 2. The error codes are as follows:

Code	Error description	Description
1	Tool 1 / Tool 2	Must be 0 or 1
2	Threshold level	Exceeds the range of 0 to 4095

#604 Write the work light brightness

Content description:

Use function code #604 to set the work light brightness of the tool.

Handshake signal description:

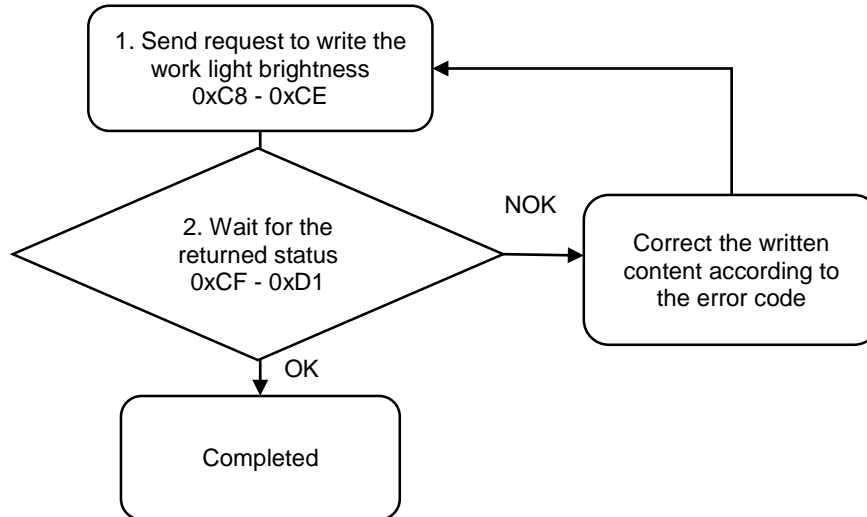

1. Fill in the write request to 0xC8 - 0xCE.

Modbus (Hex)	Write / Read request	Write
C8	Function code	604
C9	Version number	0
CA	Tool 1 / Tool 2	0: Tool 1; 1: Tool 2
CB	Brightness	0 to 50 (0: off; 50: max. brightness)
CC	Reserved	-
CD	Reserved	-
CE	Request to send command	1 (fill in lastly)

2. Then check whether the writing is successful from the returned status in 0xCF - 0xD1.

Modbus (Hex)	Returned status	Description
CF	Function code	604
D0	Returned status	1: OK; 2: NOK
D1	Error code	Error code

If successful, the returned status (0xD0) is read as 1.

If failed, the returned status (0xD1) is read as 2. The error codes are as follows:

Code	Error description	Description
1	Tool 1 / Tool 2	Must be 0 or 1
2	Brightness	Exceeds the range of 0 to 50

#606 Write the LED light settings

Content description:

Use function code #606 to set the LED light settings of the tool.

Handshake signal description:

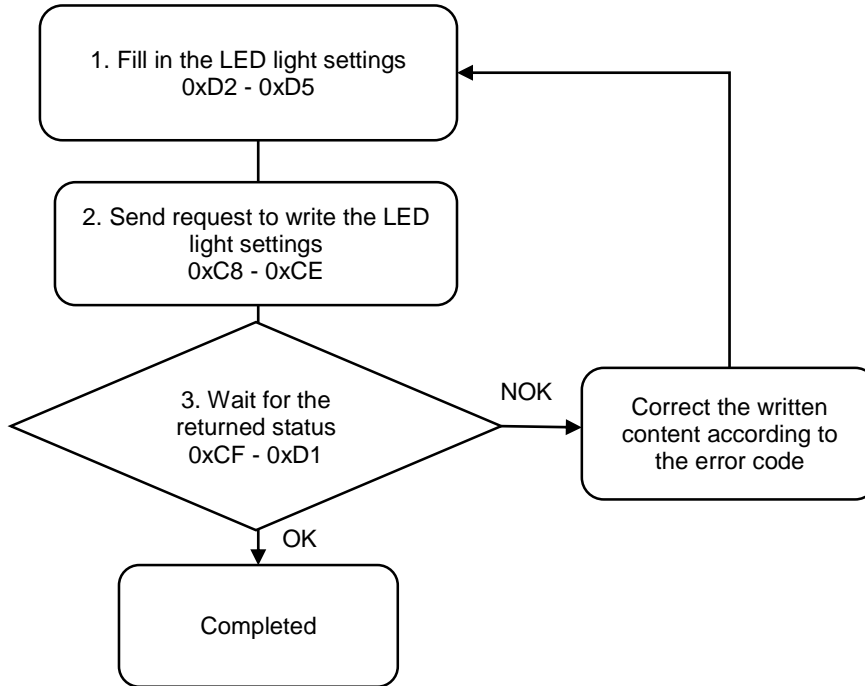

A

1. Fill in the LED light settings to 0xD2 - 0xD5.

Modbus (Hex)	Function	Description
D2	NO / NC	0: NO (Normally open) 1: NC (Normally closed) (BIT 1 - 8: for Tool 1; BIT 9 - 16: for Tool 2)
D3	Output status for red indicator	0: not in use 1: ready 2: running
D4	Output status for yellow indicator	3: tightening OK 4: tightening NOK
D5	Output status for green indicator	5: loosening OK 6: loosening NOK 7: total screw quantity reached

2. Fill in the write request to 0xC8 - 0xCE.

Modbus (Hex)	Write / Read request	Write
C8	Function code	606
C9	Version number	0
CA	Tool 1 / Tool 2	0: Tool 1; 1: Tool 2
CB	Reserved	-
CC	Reserved	-
CD	Reserved	-
CE	Request to send command	1 (fill in lastly)

3. Then check whether the writing is successful from the returned status in 0xCF - 0xD1.

Modbus (Hex)	Returned status	Description
CF	Function code	606
D0	Returned status	1: OK; 2: NOK
D1	Error code	Error code

If successful, the returned status (0xD0) is read as 1.

If failed, the returned status (0xD1) is read as 2. The error code is as follows:

Code	Error description	Description
1	Tool 1 / Tool 2	Must be 0 or 1

#607 Write the tool calibration

Content description:

Use function code #607 to set the precision of the tool.

Handshake signal description:

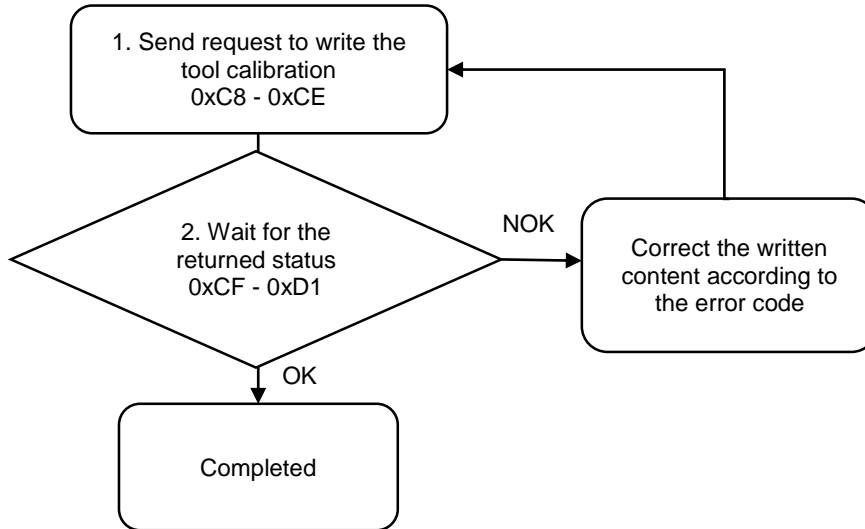

1. Fill in the write request to 0xC8 - 0xCE.

Modbus (Hex)	Write / Read request	Write
C8	Function code	607
C9	Version number	0
CA	Tool 1 / Tool 2	0: Tool 1; 1: Tool 2
CB	Precision	0 to 32767 (default: 1400 for 12 kgf-cm models 3500 for 30 kgf-cm models 6000 for 50 kgf-cm models)
CC - CD	Reserved	-
CE	Request to send command	1 (fill in lastly)

2. Then check whether the writing is successful from the returned status in 0xCF - 0xD1.

Modbus (Hex)	Returned status	Description
CF	Function code	607
D0	Returned status	1: OK; 2: NOK
D1	Error code	Error code

If successful, the returned status (0xD0) is read as 1.

If failed, the returned status (0xD1) is read as 2. The error codes are as follows:

Code	Error description	Description
1	Tool 1 / Tool 2	Must be 0 or 1
2	Set value exceeds range	Exceeds the range of 0 to 32767

A

#650 Read the tool information

Content description:

Use function code #650 to read the tool specifications.

Handshake signal description:

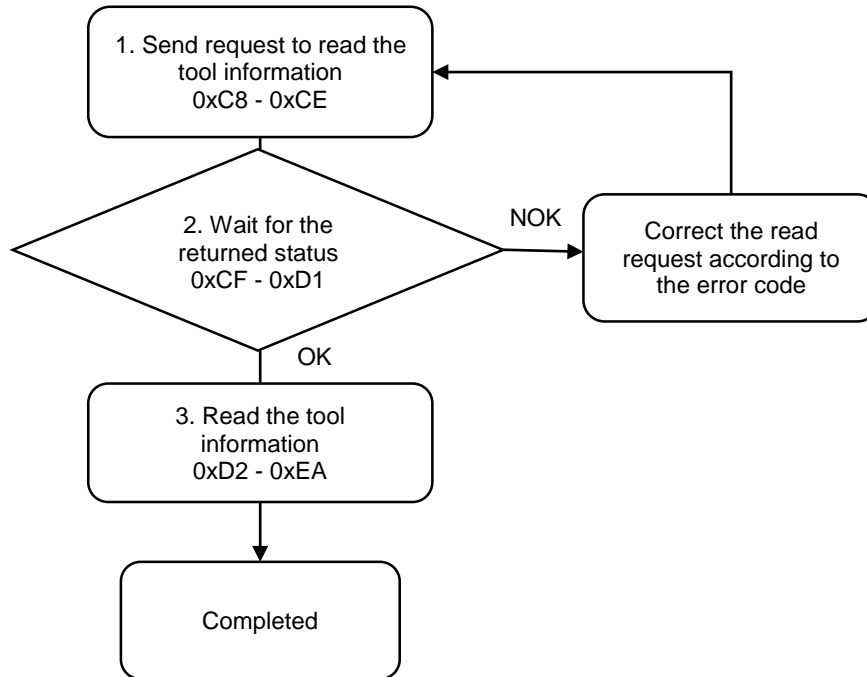

1. Fill in the read request to 0xC8 - 0xCE.

Modbus (Hex)	Write / Read request	Write
C8	Function code	650
C9	Version number	0
CA	Tool 1 / Tool 2	0: Tool 1; 1: Tool 2
CB - CD	Reserved	-
CE	Request to send command	1 (fill in lastly)

2. Check whether the reading is successful from the returned status in 0xCF - 0xD1.

Modbus (Hex)	Returned status	Description
CF	Function code	650
D0	Returned status	1: OK; 2: NOK
D1	Error code	Error code

If successful, the returned status (0xD0) is read as 1.

If failed, the returned status (0xD0) is read as 2. The error code is as follows:

Code	Error description	Description
1	Tool 1 / Tool 2	Must be 0 or 1

3. Obtain the tool information from 0xD2 - 0xEA.

Modbus (Hex)	Function	Description
D2 - E5	Model name (20 words)	ASCII code
E6	Max. speed	Unit: rpm
E7	Max. torque	Unit: 0.001 Nm
E8	Tool temperature	Unit: °C
E9	Tightenings count (L)	Tool life
EA	Tightenings count (H)	

A

#651 Read the lever start level

Content description:

Use function code #651 to read the lever start level of the tool.

Handshake signal description:

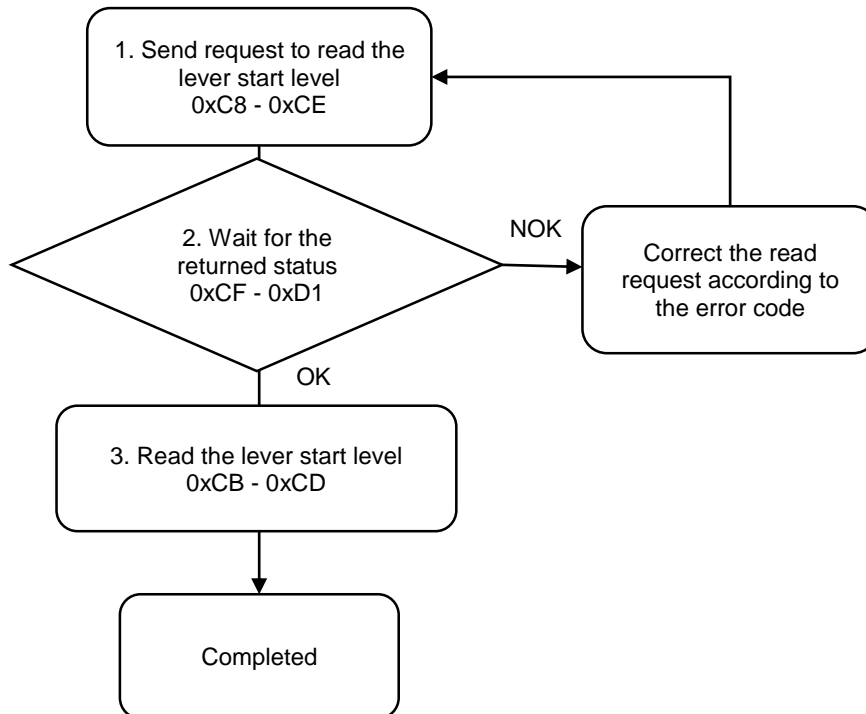

1. Fill in the read request to 0xC8 - 0xCE.

Modbus (Hex)	Write / Read request	Write
C8	Function code	651
C9	Version number	0
CA	Tool 1 / Tool 2	0: Tool 1; 1: Tool 2
CB - CD	Reserved	-
CE	Request to send command	1 (fill in lastly)

2. Check whether the reading is successful from the returned status in 0xCF - 0xD1.

Modbus (Hex)	Returned status	Description
CF	Function code	651
D0	Returned status	1: OK; 2: NOK
D1	Error code	Error code

If successful, the returned status (0xD0) is read as 1.

If failed, the returned status (0xD0) is read as 2. The error code is as follows:

Code	Error description	Description
1	Tool 1 / Tool 2	Must be 0 or 1

3. Obtain the information from 0xCB - 0xCD.

Modbus (Hex)	Returned status	Description
CB	Currently pressed threshold level	0 to 4095
CC	ON threshold level	0 to 4095
CD	Off threshold level	0 to 4095

#652 Read the push start level

Content description:

Use function code #652 to read the push start level of the tool.

Handshake signal description:

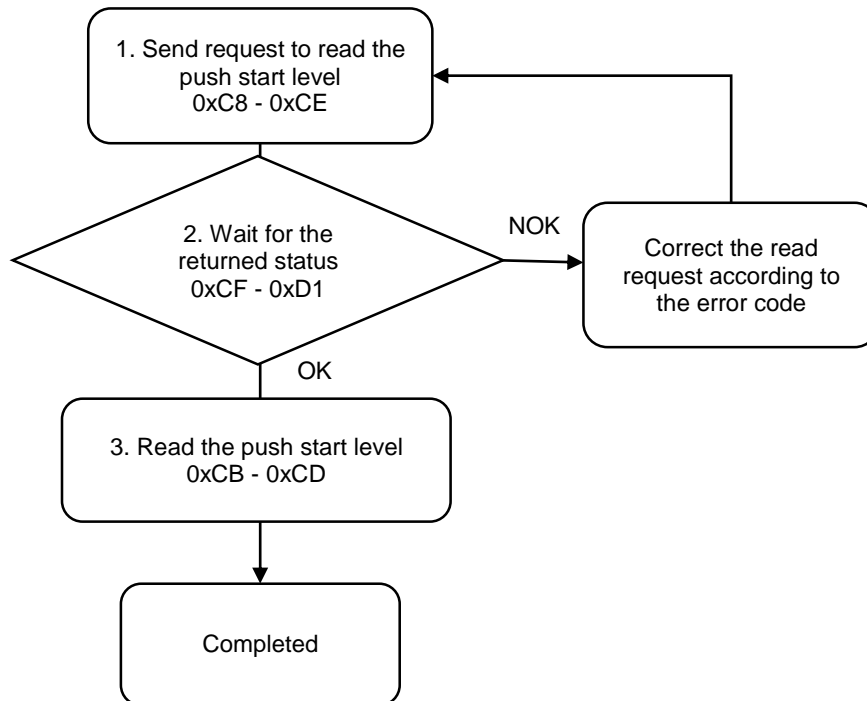

1. Fill in the read request to 0xC8 - 0xCE.

Modbus (Hex)	Write / Read request	Write
C8	Function code	652
C9	Version number	0
CA	Tool 1 / Tool 2	0: Tool 1; 1: Tool 2
CB	Reserved	-
CC	Reserved	-
CD	Reserved	-
CE	Request to send command	1 (fill in lastly)

2. Check whether the reading is successful from the returned status in 0xCF - 0xD1.

Modbus (Hex)	Returned status	Description
CF	Function code	652
D0	Returned status	1: OK; 2: NOK
D1	Error code	Error code

If successful, the returned status (0xD0) is read as 1.

If failed, the returned status (0xD0) is read as 2. The error code is as follows:

Code	Error description	Description
1	Tool 1 / Tool 2	Must be 0 or 1

3. Obtain the information from 0xCB - 0xCD.

Modbus (Hex)	Returned status	Description
CB	Currently pressed threshold level	0 to 4095
CC	ON threshold level	0 to 4095
CD	Off threshold level	0 to 4095

A

#653 Read the work light brightness

Content description:

Use function code #653 to read the work light brightness of the tool.

Handshake signal description:

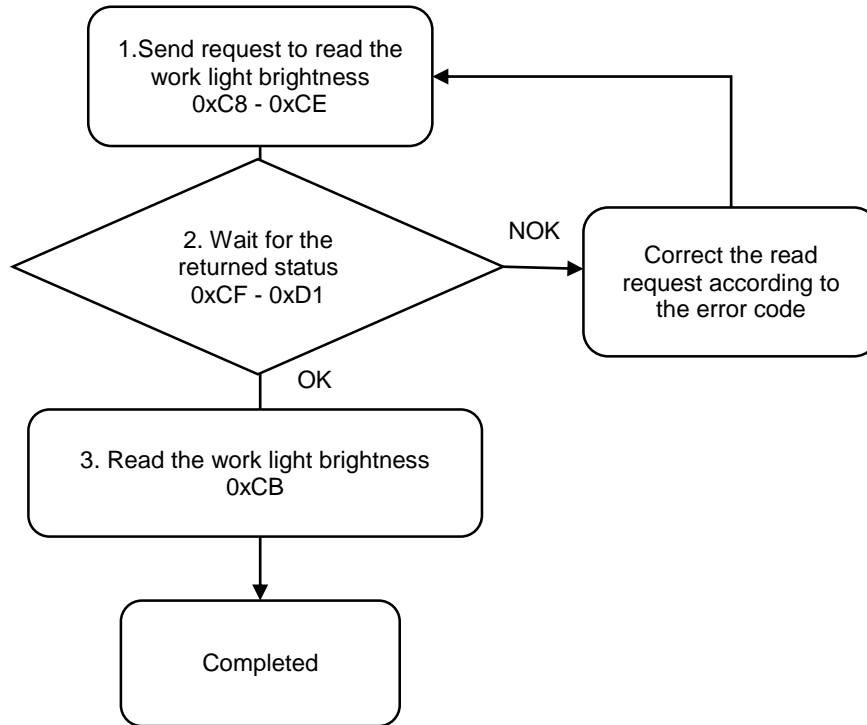

1. Fill in the read request to 0xC8 - 0xCE.

Modbus (Hex)	Write / Read request	Write
C8	Function code	653
C9	Version number	0
CA	Tool 1 / Tool 2	0: Tool 1; 1: Tool 2
CB	Reserved	-
CC	Reserved	-
CD	Reserved	-
CE	Request to send command	1 (fill in lastly)

2. Check whether the reading is successful from the returned status in 0xCF - 0xD1.

Modbus (Hex)	Returned status	Description
CF	Function code	653
D0	Returned status	1: OK; 2: NOK
D1	Error code	Error code

If successful, the returned status (0xD0) is read as 1.

If failed, the returned status (0xD0) is read as 2. The error code is as follows:

Code	Error description	Description
1	Tool 1 / Tool 2	Must be 0 or 1

3. Obtain the information from 0xCB.

Modbus (Hex)	Returned status	Description
CB	Current work light brightness	0 to 50 (0: off; 50: max. brightness)



#655 Read the LED light settings

Content description:

Use function code #655 to read the LED light settings of the tool.

Handshake signal description:

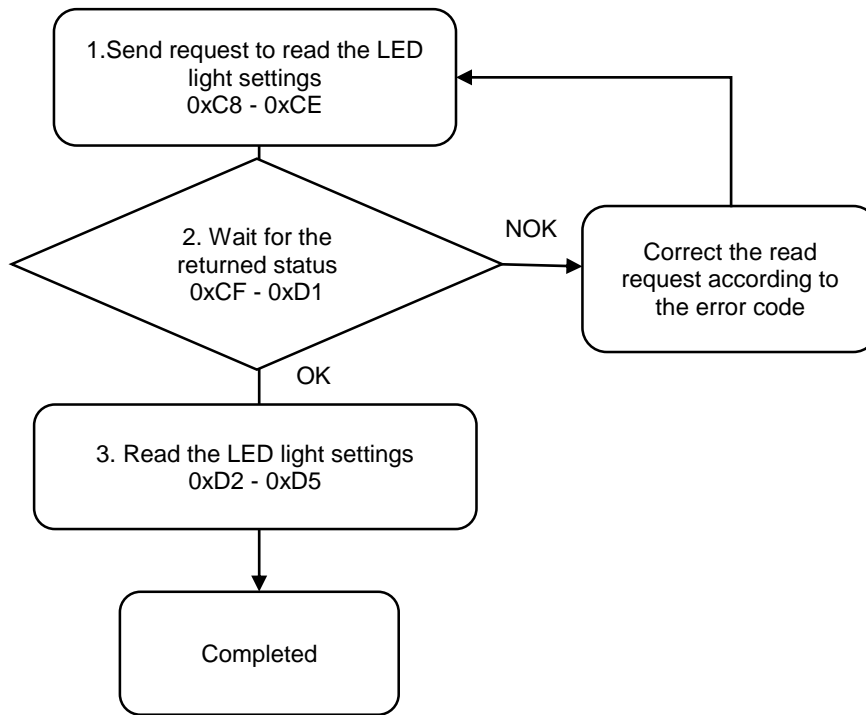

1. Fill in the read request to 0xC8 - 0xCE.

Modbus (Hex)	Write / Read request	Write
C8	Function code	655
C9	Version number	0
CA	Tool 1 / Tool 2	0: Tool 1; 1: Tool 2
CB	Reserved	-
CC	Reserved	-
CD	Reserved	-
CE	Request to send command	1 (fill in lastly)

2. Check whether the reading is successful from the returned status in 0xCF - 0xD1.

Modbus (Hex)	Returned status	Description
CF	Function code	655
D0	Returned status	1: OK; 2: NOK
D1	Error code	Error code

If successful, the returned status (0xD0) is read as 1.

If failed, the returned status (0xD0) is read as 2. The error code is as follows:

Code	Error description	Description
1	Tool 1 / Tool 2	Must be 0 or 1

3. Obtain the tool information from 0xD2 - 0xD5.

Modbus (Hex)	Function	Description
D2	NO / NC	0: NO (Normally open) 1: NC (Normally closed) (BIT 1 - 8: for Tool 1; BIT 9 - 16: for Tool 2)
D3	Output status for red indicator	0: not in use 1: ready 2: running
D4	Output status for yellow indicator	3: tightening OK 4: tightening NOK
D5	Output status for green indicator	5: loosening OK 6: loosening NOK 7: total screw quantity reached

#656 Read the tool calibration

Content description:

Use function code #656 to read the precision of the tool.

Handshake signal description:

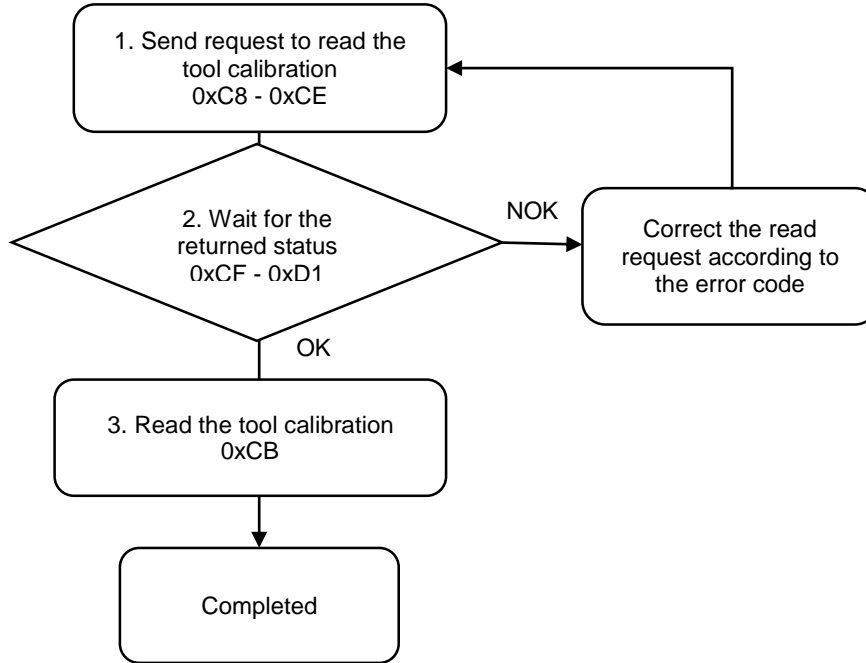

A

1. Fill in the read request to 0xC8 - 0xCE.

Modbus (Hex)	Write / Read request	Write
C8	Function code	656
C9	Version number	0
CA	Tool 1 / Tool 2	0: Tool 1; 1: Tool 2
CB - CD	Reserved	-
CE	Request to send command	1 (fill in lastly)

2. Check whether the reading is successful from the returned status in 0xCF - 0xD1.

Modbus (Hex)	Returned status	Description
CF	Function code	656
D0	Returned status	1: OK; 2: NOK
D1	Error code	Error code

If successful, the returned status (0xD0) is read as 1.

If failed, the returned status (0xD0) is read as 2. The error code is as follows:

Code	Error description	Description
1	Tool 1 / Tool 2	Must be 0 or 1

3. Obtain the information from 0xCB.

Modbus (Hex)	Returned status	Description
CB	Precision	1400 for 12 kgf-cm models 3500 for 30 kgf-cm models 6000 for 50 kgf-cm models

A.3.7 Reports operations

Reports			
Function code	Function name	Function code	Function name
#700	Clear the production report entries	#750	Find and read the production report entries
#701	Clear the error and warning report entries	#751	Find and read curves
-	-	#752	Find and read the error report entries
-	-	#753	Find and read the warning report entries

#700 Clear the production report entries

Content description:

Use function code #700 to delete all of the production report entries from the controller.

Handshake signal description:

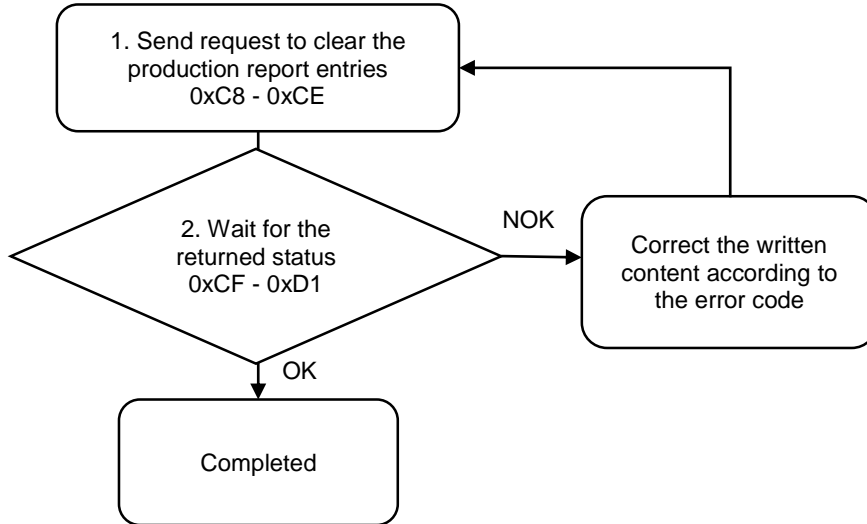

1. Fill in the write request to 0xC8 - 0xCE.

Modbus (Hex)	Write / Read request	Write
C8	Function code	700
C9	Version number	0
CA	Confirm command	99
CB	Reserved	-
CC	Reserved	-
CD	Reserved	-
CE	Request to send command	1 (fill in lastly)

2. Then check whether the writing is successful from the returned status in 0xCF - 0xD1.

Modbus (Hex)	Returned status	Description
CF	Function code	700
D0	Returned status	1: OK; 2: NOK
D1	Error code	Error code

If successful, the returned status (0xD0) is read as 1.

If failed, the returned status (0xD1) is read as 2. The error code is as follows:

Code	Error description	Description
1	Confirm command	Must be 99

A

#701 Clear the error and warning report entries

Content description:

Use function code #701 to delete all of the error and warning report entries from the controller.

Handshake signal description:

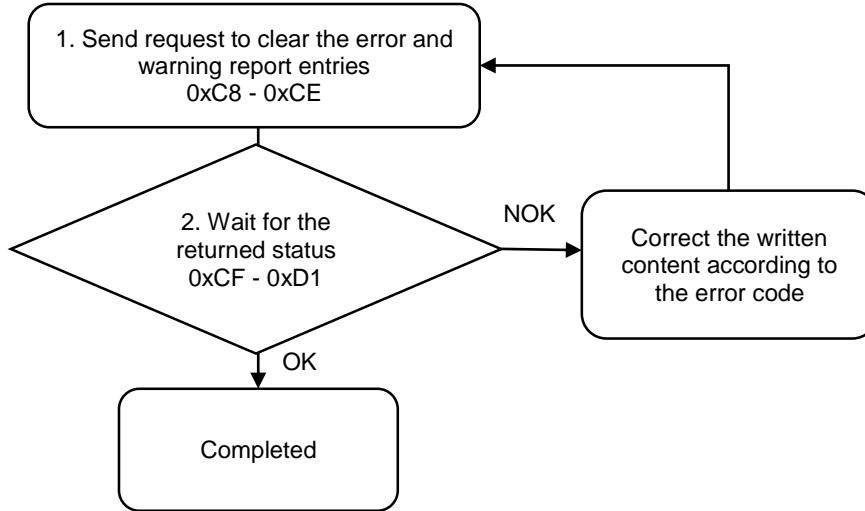

1. Fill in the write request to 0xC8 - 0xCE.

Modbus (Hex)	Write / Read request	Write
C8	Function code	701
C9	Version number	0
CA	Confirm command	99
CB	Reserved	-
CC	Reserved	-
CD	Reserved	-
CE	Request to send command	1 (fill in lastly)

2. Then check whether the writing is successful from the returned status in 0xCF - 0xD1.

Modbus (Hex)	Returned status	Description
CF	Function code	701
D0	Returned status	1: OK; 2: NOK
D1	Error code	Error code

If successful, the returned status (0xD0) is read as 1.

If failed, the returned status (0xD1) is read as 2. The error code is as follows:

Code	Error description	Description
1	Confirm command	Must be 99

#750 Find and read the production report entries

Content description:

Use function code #750 to read the production report information.

A. Used with 0x6B - 0x6C (Current No. of production report entries) to check the content of the latest production report.

6B	Current No. of production report entries (L)	R
6C	Current No. of production report entries (H)	R

B. Check the content of history report entries.

Handshake signal description:

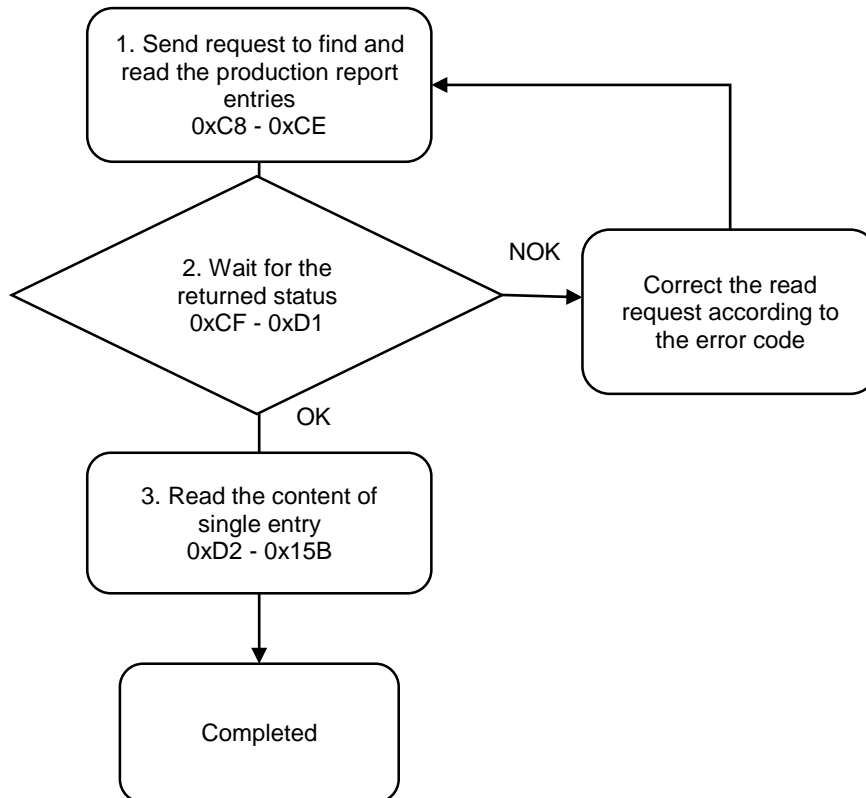

1. Fill in the read request to 0xC8 - 0xCE.

Modbus (Hex)	Write / Read request	Write
C8	Function code	750
C9	Version number	0
CA	Production report ID (L)	1 to 200000
CB	Production report ID (H)	
CC	Reserved	-
CD	Reserved	-
CE	Request to send command	1 (fill in lastly)



2. Check whether the reading is successful from the returned status in 0xCF - 0xD1.

Modbus (Hex)	Returned status	Description
CF	Function code	750
D0	Returned status	1: OK; 2: NOK
D1	Error code	Error code

If successful, the returned status (0xD0) is read as 1, and the content of the production report entry is obtained.

If failed, the returned status (0xD0) is read as 2. The error code is as follows:

Code	Error description	Description
1	Production report ID	Exceeds the range of 1 to 200000

3. Obtain information from 0xD2 - 0x15B.

Modbus (Hex)	Function	Description
D2 - 135	Saved scanner string (100 words)	ASCII code
136	Year	-
137	Month	-
138	Day	-
139	Hour	-
13A	Minute	-
13B	Second	-
13C	Tool 1 / Tool 2	0: Tool 1; 1: Tool 2
13D	Current screw progress ID (L)	-
13E	Current screw progress ID (H)	-
13F	Sequence ID	-
140	Parameter ID	-
141	Target torque	-
142	Target angle	-
143	Target torque rate	-
144	Final torque	-
145	Tightening angle	-
146	Rotation angle	-
147	Current status	0: tightening OK; 1: tightening NOK; 2: loosening OK; 3: loosening NOK; 4: pass
148	Operation time	-
149	Error code	Refer to CH13
14A	Max. angle of final stage	-
14B	Min. angle of final stage	-
14C	Max. torque of final stage	-
14D	Min. torque of final stage	-
14E	Torque unit	0: Nm; 1: kgf-cm 2: lbf-ft; 3: lbf-in

Modbus (Hex)	Function	Description
14F	Torque specification of the tool	-
150	Max. torque of the tool	-
151	Pre-tightening torque	-
152	Set total operation time	-
153	Set total running angle	-
154	Max. torque	Torque upper limit when the current stage finishes
155	Min. torque	Torque lower limit when the current stage finishes
156	Max. angle	Angle upper limit when the current stage finishes
157	Min. angle	Angle lower limit when the current stage finishes
158	Max. operation time	Time upper limit when the current stage finishes
159	Min. operation time	Time lower limit when the current stage finishes
15A	Prevail torque	-
15B	Final + Prevail torque	-

A

#751 Find and read curves

Content description:

Use function code #751 to read the information of the operation curve.

- A. Used with 0x6B - 0x6C (Current No. of production report entries) to check the content of the latest curve.

6B	Current No. of production report entries (L)	R
6C	Current No. of production report entries (H)	R

- B. Check the content of history curves.
- C. Set the time as X axis and the torque as Y axis to draw a torque-time coordinate graph. This graph plots the highest and lowest values.
- D. Set the angle as X axis and the torque as Y axis to draw a torque-angle coordinate graph. This graph plots the highest and lowest values.
- E. Set the angle as X axis and the torque rate as Y axis to draw a torque rate-angle coordinate graph. This graph plots the highest and lowest values.
- F. Check the parameters content of the curve.

Handshake signal description:

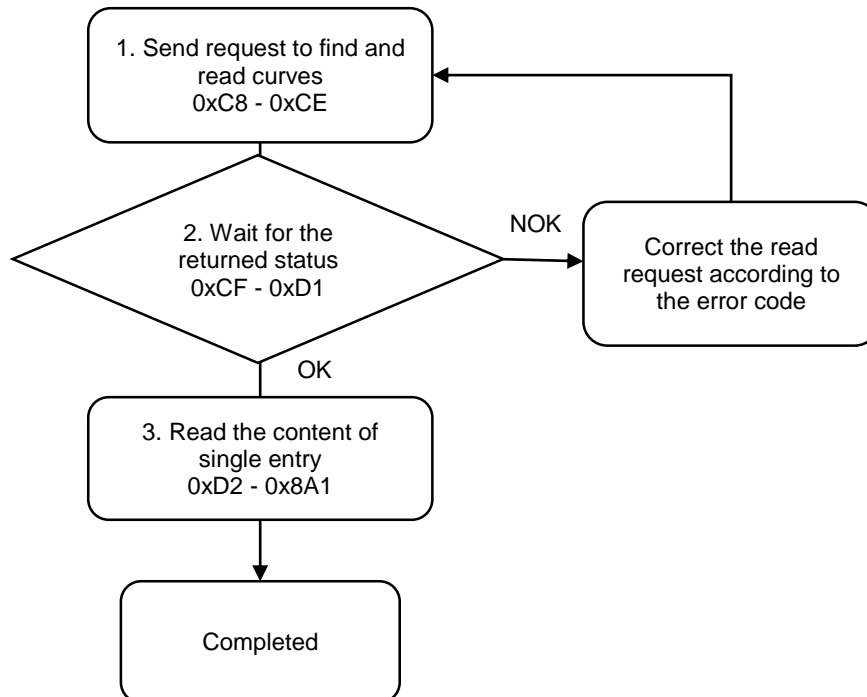

1. Fill in the read request to 0xC8 - 0xCE.

Modbus (Hex)	Write / Read request	Write
C8	Function code	751
C9	Version number	0
CA	Production report ID (L)	1 to 200000
CB	Production report ID (H)	
CC	Query type	0: time scale data (2000 words) 1: angle scale data (2000 words) 2: torque scale data (2000 words) 3: torque rate scale data (2000 words) 10: values of coordinate axis (50 words) 11: parameters (550 words)
CD	Reserved	-
CE	Request to send command	1 (fill in lastly)

2. Check whether the reading is successful from the returned status in 0xCF - 0xD1.

Modbus (Hex)	Returned status	Description
CF	Function code	751
D0	Returned status	1: OK; 2: NOK
D1	Error code	Error code

If successful, the returned status (0xD0) is read as 1, and the content of the curve is obtained.

If failed, the returned status (0xD0) is read as 2. The error codes are as follows:

Code	Error description	Description
1	Production report ID	Exceeds the range of 1 to 200000
2	Query type does not exist	Must be 0, 1, 2, 3, 10, or 11

3. Obtain the information from 0xD2 - 0x8A1.

Modbus (Hex)	Query type 0	Query type 1
D2	Time scale 1	Angle scale 1
D3	Time scale 2	Angle scale 2
D4	Time scale 3	Angle scale 3
D5	Time scale 4	Angle scale 4
D6	Time scale 5	Angle scale 5
D7	Time scale 6	Angle scale 6
D8	Time scale 7	Angle scale 7
D9	Time scale 8	Angle scale 8
DA	Time scale 9	Angle scale 9
...	Time scale N	Angle scale N
898	Time scale 1991	Angle scale 1991
899	Time scale 1992	Angle scale 1992
89A	Time scale 1993	Angle scale 1993
89B	Time scale 1994	Angle scale 1994
89C	Time scale 1995	Angle scale 1995

A

Modbus (Hex)	Query type 0	Query type 1
89D	Time scale 1996	Angle scale 1996
89E	Time scale 1997	Angle scale 1997
89F	Time scale 1998	Angle scale 1998
8A0	Time scale 1999	Angle scale 1999
8A1	Time scale 2000	Angle scale 2000

Modbus (Hex)	Query type 2	Query type 3
D2	Torque scale 1	Torque rate scale 1
D3	Torque scale 2	Torque rate scale 2
D4	Torque scale 3	Torque rate scale 3
D5	Torque scale 4	Torque rate scale 4
D6	Torque scale 5	Torque rate scale 5
D7	Torque scale 6	Torque rate scale 6
D8	Torque scale 7	Torque rate scale 7
D9	Torque scale 8	Torque rate scale 8
DA	Torque scale 9	Torque rate scale 9
...	Torque scale N	Torque rate scale N
898	Torque scale 1991	Torque rate scale 1991
899	Torque scale 1992	Torque rate scale 1992
89A	Torque scale 1993	Torque rate scale 1993
89B	Torque scale 1994	Torque rate scale 1994
89C	Torque scale 1995	Torque rate scale 1995
89D	Torque scale 1996	Torque rate scale 1996
89E	Torque scale 1997	Torque rate scale 1997
89F	Torque scale 1998	Torque rate scale 1998
8A0	Torque scale 1999	Torque rate scale 1999
8A1	Torque scale 2000	Torque rate scale 2000

Modbus (Hex)	Query type 10	Description
0	Running angle of stage 1	Unit: degree
1	Running angle of stage 2	Unit: degree
2	Running angle of stage 3	Unit: degree
3	Running angle of stage 4	Unit: degree
4	Running angle of stage 5	Unit: degree
5	Running angle of stage 6	Unit: degree
6	Running angle of loosening stage 1	Unit: degree
7	Running angle of loosening stage 2	Unit: degree
8	Max. torque of stage 1	Unit: current torque unit
9	Max. torque of stage 2	Unit: current torque unit
A	Max. torque of stage 3	Unit: current torque unit
B	Max. torque of stage 4	Unit: current torque unit
C	Max. torque of stage 5	Unit: current torque unit
D	Max. torque of stage 6	Unit: current torque unit
E	Max. torque of loosening stage 1	Unit: current torque unit
F	Max. torque of loosening stage 2	Unit: current torque unit
10	Operation time of stage 1	Unit: ms

Modbus (Hex)	Query type 10	Description
11	Operation time of stage 2	Unit: ms
12	Operation time of stage 3	Unit: ms
13	Operation time of stage 4	Unit: ms
14	Operation time of stage 5	Unit: ms
15	Operation time of stage 6	Unit: ms
16	Operation time of loosening stage 1	Unit: ms
17	Operation time of loosening stage 2	Unit: ms
18	Max. time on the scale	Unit: ms
19	Max. angle on the scale	Unit: degree
1A	Max. torque on the scale	Unit: current torque unit
1B	Max. torque rate on the scale	Unit: current torque rate unit
1C	Total number of curve coordinates	-
1D	Max. torque	Unit: current torque unit
1E	Min. torque	Unit: current torque unit
1F	Max. torque rate	Unit: current torque rate unit
20	Max. angle	Unit: degree
21	Min. angle	Unit: degree
22 to 31	Reserved	-

Modbus (Hex)								Query type 11	Description	
D2								Parameter ID	1 to 500	
DC								Tool 1 / Tool 2	0: Tool 1; 1: Tool 2	
E8								Max. tightening time	Unit: ms	
E9								Max. tightening angle	Unit: degree	
EB								Delay before tightening starts	Unit: ms	
F2								Max. loosening time	Unit: ms	
F3								Max. loosening angle	Unit: degree	
F5								Delay before loosening starts	Unit: ms	
FB								ID of the prevail torque to be linked	1 to 500	
104	136	19A	1CC	1FE	230	262	294	Targets On / Off (L)	BIT 0 to 1 Control mode type	0: position mode 1: speed mode
									BIT 2 to 3 Operation after stage completion	0: stop 1: execute the next stage
									BIT 4 to 5 Control mode	0: angle 1: torque 2: torque rate
									BIT 6 Rotation direction for the stage	0: CW 1: CCW
									BIT 7 to 8 Hold time switch of the final stage	0: off 1: on

A

Modbus (Hex)								Query type 11	Description	
									BIT 9 Prevail torque	0: off 1: on
105	137	19B	1CD	1FF	231	263	295	Targets On / Off (H)	Reserved	
106	138	19C	1CE	200	232	264	296	Target torque	Unit: 0.001 Nm (used with Targets On / Off BIT 4, 1: torque)	
107	139	19D	1CF	201	233	265	297	Rotation speed	Unit: rpm	
108	13A	19E	1D0	202	234	266	298	Target angle	Unit: degree (used with Targets On / Off BIT 4, 0: angle)	
109	13B	19F	1D1	203	235	267	299	Hold / pause time after stage completion	Unit: ms	
10A	13C	1A0	1D2	204	236	268	29A	Acceleration time	Unit: ms	
10B	13D	1A1	1D3	205	237	269	29B	Deceleration time	Unit: ms	
10C	13E	1A2	1D4	206	238	26A	29C	Start torque for torque rate calculation	-	
10D	13F	1A3	1D5	207	239	26B	29D	Angle interval for torque rate calculation	-	
10E	140	1A4	1D6	208	23A	26C	29E	Target torque rate	Unit: 0.0001 Nm/degree (used with Targets On / Off BIT 4, 2: torque rate)	
10F	141	1A5	1D7	209	23B	26D	29F	Reserved	-	
110	142	1A6	1D8	20A	23C	26E	2A0	Reserved	-	
111	143	1A7	1D9	20B	23D	26F	2A1	Reserved	-	
112	144	1A8	1DA	20C	23E	270	2A2	Reserved	-	
113	145	1A9	1DB	20D	23F	271	2A3	Reserved	-	
114	146	1AA	1DC	20E	240	272	2A4	Reserved	-	
115	147	1AB	1DD	20F	241	273	2A5	Reserved	-	
116	148	1AC	1DE	210	242	274	2A6	Reserved	-	
117	149	1AD	1DF	211	243	275	2A7	Reserved	-	
118	14A	1AE	1E0	212	244	276	2A8	Reserved	-	
119	14B	1AF	1E1	213	245	277	2A9	Reserved	-	
11A	14C	1B0	1E2	214	246	278	2AA	Reserved	-	
11B	14D	1B1	1E3	215	247	279	2AB	Reserved	-	
11C	14E	1B2	1E4	216	248	27A	2AC	Reserved	-	
11D	14F	1B3	1E5	217	249	27B	2AD	Reserved	-	
11E	150	1B4	1E6	218	24A	27C	2AE	Limit the max. angle	Used with Limit On / Off BIT 2	
11F	151	1B5	1E7	219	24B	27D	2AF	Limit the min. angle	Used with Limit On / Off BIT 2	
120	152	1B6	1E8	21A	24C	27E	2B0	Reserved	-	
121	153	1B7	1E9	21B	24D	27F	2B1	Reserved	-	
122	154	1B8	1EA	21C	24E	280	2B2	Limit the max. torque	Used with Limit On / Off BIT 0	
123	155	1B9	1EB	21D	24F	281	2B3	Limit the min. torque	Used with Limit On / Off BIT 0	
124	156	1BA	1EC	21E	250	282	2B4	Reserved	-	
125	157	1BB	1ED	21F	251	283	2B5	Reserved	-	

A

Modbus (Hex)								Query type 11	Description
126	158	1BC	1EE	220	252	284	2B6	Reserved	-
127	159	1BD	1EF	221	253	285	2B7	Reserved	-
128	15A	1BE	1F0	222	254	286	2B8	Reserved	-
129	15B	1BF	1F1	223	255	287	2B9	Reserved	-
12A	15C	1C0	1F2	224	256	288	2BA	Reserved	-
12B	15D	1C1	1F3	225	257	289	2BB	Max. operation time	Unit: ms Used with Limit On / Off BIT 15
12C	15E	1C2	1F4	226	258	28A	2BC	Min. operation time	Unit: ms Used with Limit On / Off BIT 15
12D	15F	1C3	1F5	227	259	28B	2BD	Reserved	-
12E	160	1C4	1F6	228	25A	28C	2BE	Reserved	-
12F	161	1C5	1F7	229	25B	28D	2BF	Angle range for prevail torque calculation	Set the angle range (%) of the stage to calculate the average torque
130	162	1C6	1F8	22A	25C	28E	2C0	Reserved	-
131	163	1C7	1F9	22B	25D	28F	2C1	Reserved	-
132	164	1C8	1FA	22C	25E	290	2C2	Limit On / Off	BIT 2: limit the angle
133	165	1C9	1FB	22D	25F	291	2C3	Limit On / Off	BIT 0: limit the torque BIT 15: limit the operation time
134	166	1CA	1FC	22E	260	292	2C4	Reserved	-
135	167	1CB	1FD	22F	261	293	2C5	Stage code	10: start stage 20: rundown stage (angle / torque mode) 29: rundown stage (torque rate mode) 30: pre-tightening stage 40: tightening stage 90: first stage of loosening 91: second stage of loosening

A

#752 Find and read the error report entries

Content description:

Use function code #752 with 0x69 (the current No. of error report entries) to check the error report entries information.

A

69	Current No. of error report entries	R
----	-------------------------------------	---

Handshake signal description:

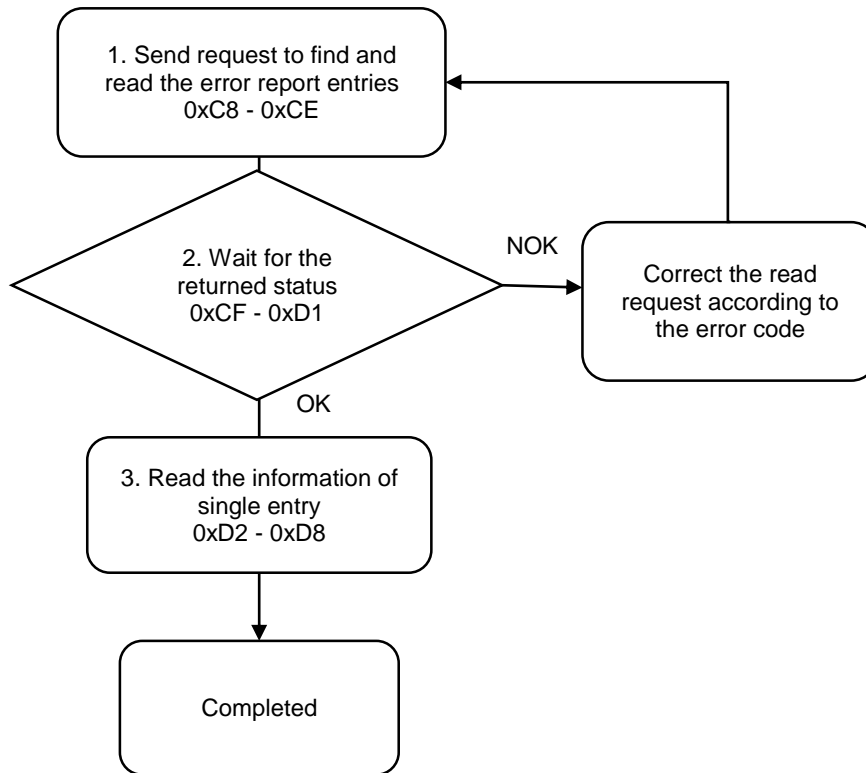

1. Fill in the read request to 0xC8 - 0xCE.

Modbus (Hex)	Write / Read request	Write
C8	Function code	752
C9	Version number	0
CA	Error report ID	1 to 60000
CB - CD	Reserved	-
CE	Request to send command	1 (fill in lastly)

2. Check whether the reading is successful from the returned status in 0xCF - 0xD1.

Modbus (Hex)	Returned status	Description
CF	Function code	752
D0	Returned status	1: OK; 2: NOK
D1	Error code	Error code

If successful, the returned status (0xD0) is read as 1.

If failed, the returned status (0xD0) is read as 2. The error code is as follows:

Code	Error description	Description
1	Error report ID	Exceeds the range of 1 to 60000

3. Obtain the information from 0xD2 - 0xD8.

Modbus (Hex)	Function	Description
D2	Date / Time	Year
D3	Date / Time	Month
D4	Date / Time	Day
D5	Date / Time	Hour
D6	Date / Time	Minute
D7	Date / Time	Second
D8	Error code	Refer to CH13

A

#753 Find and read the warning report entries

Content description:

Use function code #753 with 0x6A (the current No. of warning report entries) to check the warning report entries information.

6A	Current No. of warning report entries	R
----	---------------------------------------	---

Handshake signal description:

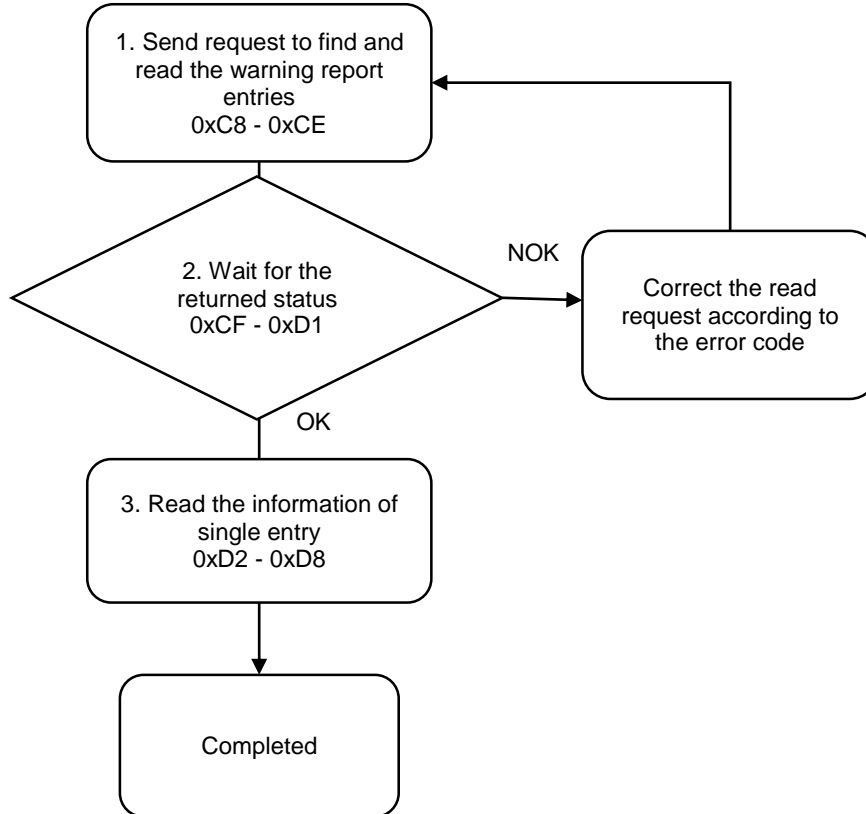

1. Fill in the read request to 0xC8 - 0xCE.

Modbus (Hex)	Write / Read request	Write
C8	Function code	753
C9	Version number	0
CA	Warning report ID	1 to 60000
CB	Reserved	-
CC	Reserved	-
CD	Reserved	-
CE	Request to send command	1 (fill in lastly)

2. Check whether the reading is successful from the returned status in 0xCF - 0xD1.

Modbus (Hex)	Returned status	Description
CF	Function code	753
D0	Returned status	1: OK; 2: NOK
D1	Error code	Error code

If successful, the returned status (0xD0) is read as 1.

If failed, the returned status (0xD0) is read as 2. The error code is as follows:

Code	Error description	Description
1	Warning report ID	Exceeds the range of 1 to 60000

3. Obtain the information from 0xD2 - 0xD8.

Modbus (Hex)	Function	Description
D2	Date / Time	Year
D3	Date / Time	Month
D4	Date / Time	Day
D5	Date / Time	Hour
D6	Date / Time	Minute
D7	Date / Time	Second
D8	Error code	Warning ID (refer to CH13)

A

(This page is intentionally left blank.)

A