

# **OPERATION MANUAL**

## **TORQUE DRIVER**

**DID-05/4**

## **TORQUE WRENCH**

**DIW-15/20/75/120**

# Thank you very much for purchasing a TORQUE TESTER DID & DIW Series.

For safe and efficient operation, read this Operation Manual through before use, get a good understanding of the operating precautions, capabilities of this product, how to use it, and other details, and use it correctly.

## Contents

<b>1 Safety Precautions</b> .....	2
<b>2 Specification</b> .....	3
2.1 The name of each part, and the main uses.....	3
2.1.2 outside dimension.....	5
2.2 Specification .....	6
<b>3 Preparation of Measurement</b> .....	7
3.1 Measurement Mode.....	7
3.1.1 Measurement Mode.....	7
3.1.2 A setup and Change in Measurement Mode .....	7
3.1.3 Setup and Change of Measurement Unit.....	7
3.2 Power Source.....	8
3.3 About zero adjustment .....	8
<b>4 Measuring Method</b> .....	9
4.1 The common operation method .....	9
4.2 Ratchet one-way function .....	9
<b>5 About a convenient function</b> .....	10
5.1 Convenient Function .....	10
5.2 The setting method of a convenient functional numerical value.....	10
5.3 How to Use Convenient Function.....	13
5.3.1 Yes-no Decision.....	13
5.3.2 Maximum, Minimum, and Average.....	13
5.3.3 To clear indication automatically .....	14
5.4 Real-time data output.....	14
<b>6 Preservation, Display, and Output of Data</b> .....	14
6.1 Measurement Data.....	14
6.1.1 Preservation of Measurement Data .....	14
6.1.2 Display and Elimination of Saved Measurement Data .....	15
6.1.3 Output of Saved Measurement Data.....	16
6.2 Output data.....	16
6.3 All Elimination of Saved Data.....	17
6.4 Change of Output Speed of Data.....	17
<b>7 System Reset</b> .....	18
<b>8 Calibration Trust Service</b> .....	18
8.1 Periodical calibration.....	18
8.2 Guarantee.....	18
8.3 When Troubled .....	19

## 1 Safety Precautions

### Meanings of the "a symbol and a signal terms"

Meanings of the "a symbol and a signal terms" indicated at the top of each precaution.

Note that even an item described in Caution may lead to a serious result depending on the case.

Be sure to observe all precautions, because every one of them describes something important.

**Warnings;** A precaution about the possibility that mishandling may result in death or serious injury of the user.

**Cautions;** A precaution about the possibility that mishandling may result in personal injury or property damage.



### Warnings

1. Do not apply the torque more than permission load.  
If the torque more than permission load is applied, a detector will be damaged and it will become the accident and the cause of an injury.
2. Keep a work place always clean. The untidy place and a work stand cause the accident.
3. Situation of work place.
  - Avoid use in the place where high temperature, high humidity, and direct rays hit, and the place with much garbage and dust.
  - Temperature uses it in the place of regularity (about 20 degrees).
  - Make a work place bright enough.
  - Do not use or charge in the place with an inflammable liquid or gas.
4. Do not bring a child close. Do not bring close to a work place except a worker.
5. Do not handle code violently. Do not move the product while holding its cord when it is attached to the product. Do not pull the cord to unplug it.
6. Services carefully.
  - In order to work with sufficient efficiency safely, the product, a bit / socket, etc. are checked periodically.
  - Exchange of accessories follows the operation manual.
  - Check a code periodically, and when having damaged, exchange them.
7. In the following case, turn off switch of the product, and pull out plug from power supply.
  - When not using or charging.
  - When fixing.
  - When danger can be expected in addition to this.
8. Check whether there is not any damaged portion.
  - Check whether there is not any damage before use enough and it checks whether it operates normally or a predetermined function is demonstrated.
  - Check whether there are not any abnormalities in all the parts that do influence in case of use.
  - Perform parts exchange according to the operation manual.
9. Use Accessories, appointed proper bit and socket.  
Do not use it except the accessories, the proper bit or the socket which are indicated by the operation manual.
10. Request repair from store.
  - Do not convert.
  - Repair is surely an order to the store of a purchase.  
If it fixes without the knowledge of repair, or technology, sufficient performance will not be demonstrated and it will become the accident and the cause of an injury.
11. Do not decompose or do not give a strong shock and a strong vibration.  
Since this product is precision apparatus, do not decompose.  
By a superfluous shock or a vibration, when a detection machine and a display part breaks down, sufficient performance is not demonstrated and it will become the accident and the cause of an injury.
12. Charge Correctly.
  - Carry out on the displayed voltage in the case of charge. Do not use a DC power supply or engine generator. It generates heat unusually and becomes the cause of a fire.
  - Perform charge in a well ventilated place. Do not cover with cloth etc. during charge.
13. It is cautious of electric shock.  
The wet hand should not describe a power-supply plug. There is fear of an electric shock.
14. A battery (contained in the product) is not thrown into fire.  
There is a burst or a possibility that a detrimental substance may come out.
15. The nickel-cadmium battery or the nickel-hydrogen battery is being used for the product of our company.  
It is recycling resources. Leave exchange to our company.

16. Connect after turning off power supply of all apparatus, when connecting with external apparatus.  
There is fear of an electric shock or apparatus damage.
17. When situations other than contents of the operation manual occur, stop use immediately, and it is inquiry.
18. When not using a main part six months or more for quality maintenance of a battery, you have to charge once in half a year. (There is a case where it becomes impossible to use a battery)

**⚠ Cautions**

1. When not using the product, keep it exactly.  
(In the dry place, the high place which a child's hand does not reach or the place which a key requires)  
When you convey, use the packing box containing the product.
2. Orderly dress performs. (Since there is a possibility that it may be involved in a rotation part, neither loose clothes nor accessories, such as a necklace, are worn.)
3. It does not work with an impossible posture. (Always brace a step and maintain balance.)
4. Work, being careful enough without being inattentive.  
\*When using the product, it carries out by being careful enough of the method of dealing with it, the method of work, a surrounding situation, etc.  
\*It is not used when it is tired.  
\*within the limits of common sense  
(Since it has written that it is common in all of products of our company, there is a portion which does not suit with some product.)

**2 Specification**

The main functions and uses of this circuit tester are explained.

2.1 The name of each part, and the main uses

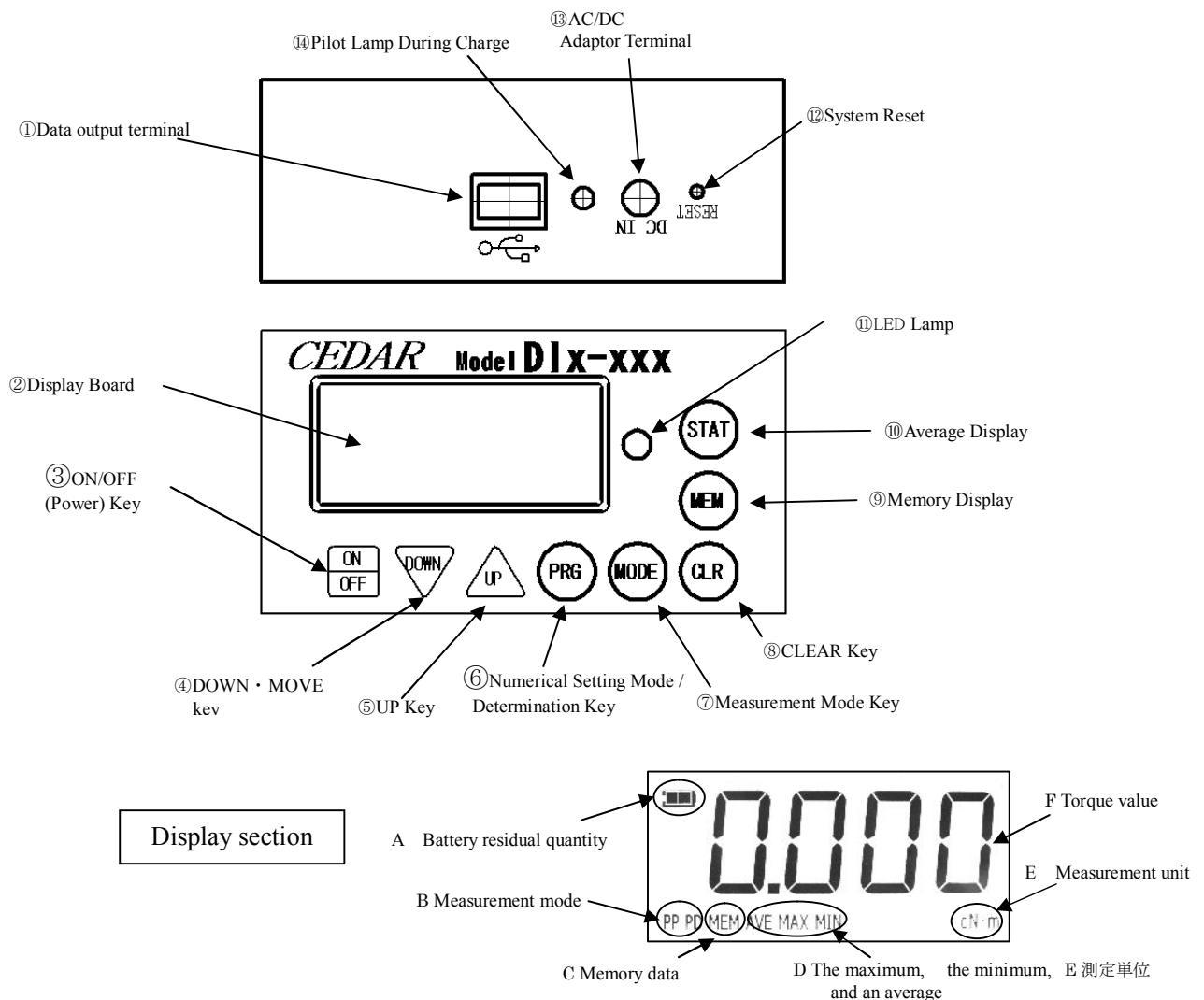

<b>The name of each part</b>	<b>The main use and contents</b>
①Data output terminal	The serial output of the measurement data is carried out. USB form (B type).
②Display Board	A torque value and various information are displayed.
③ON/OFF (Power) Key	It use it in ON/OFF of the power supply.
④DOWN Key ( DOWN•MOVE Key)	At the time of a numerical setup, when decreasing a numerical value, it is used. It is used when moving the place which changes a numerical value to the right. The memory data to choose are changed (decrease).
⑤UP Key	It is used when making a numerical value increase at the time of a functional numerical value setup. The memory data to choose are changed (increase).
⑥Numerical Setting Mode / Determination Key	It is used when changing the setting numerical value of various functions. It is used when determining a numerical value.
⑦ Measurement Mode Key	It is used when changing measurement mode. It is used for the check of the function set up during a functional numerical value setup.
⑧ CLEAR (Clear) Key	It pushes, when measurement is completed, and giving an indication zero. When the memory data is deleted, it uses it. It is used at the time of zero adjustment.
⑨ Memory Display / Data Output Key	It is used when displaying the memory data saved on the main part. It uses, when outputting the saved data.
⑩ Average Display	It is used when displaying the maximum, the minimum, and the average of measured value.
⑪LED Lamp	*It is setting within the limits, L.E.D. (green) lights up, and L.E.D. (red) can blink and check out of the setting range. *When a peak-down operates (when torque catches the moment which went into descent from the rise) , it can check by L.E.D. (green) lighting. *If the number of screw bundle setup is reached, it can check by lighting three L.E.D. (green).
⑫ System Reset	The time of full electric discharge etc. is used when resetting a system.
⑬ AC/DC Adaptor Terminal	The plug of an AC/DC adaptor is inserted.
⑭ Pilot Lamp During Charge	The light is switched on during charge. The AC/DC adaptor of exclusive use is used for charge.
Display section	
A Battery residual quantity	The residual quantity of an internal charge of battery is displayed.
B Measurement mode	A chosen measurement mode is displayed.
C Memory data	When a memory data is used, it displays.
D The maximum, the minimum, and an average	When a maximum, the minimum, and the average value are used, it displays.
E Measurement unit	The measurement unit chosen now is displayed.
F Torque value	The torque value in each measurement mode and unit is displayed.

\*Measurement while charging cannot be performed. A plug is pulled out at the time of measurement.

2.1.2 outside dimension

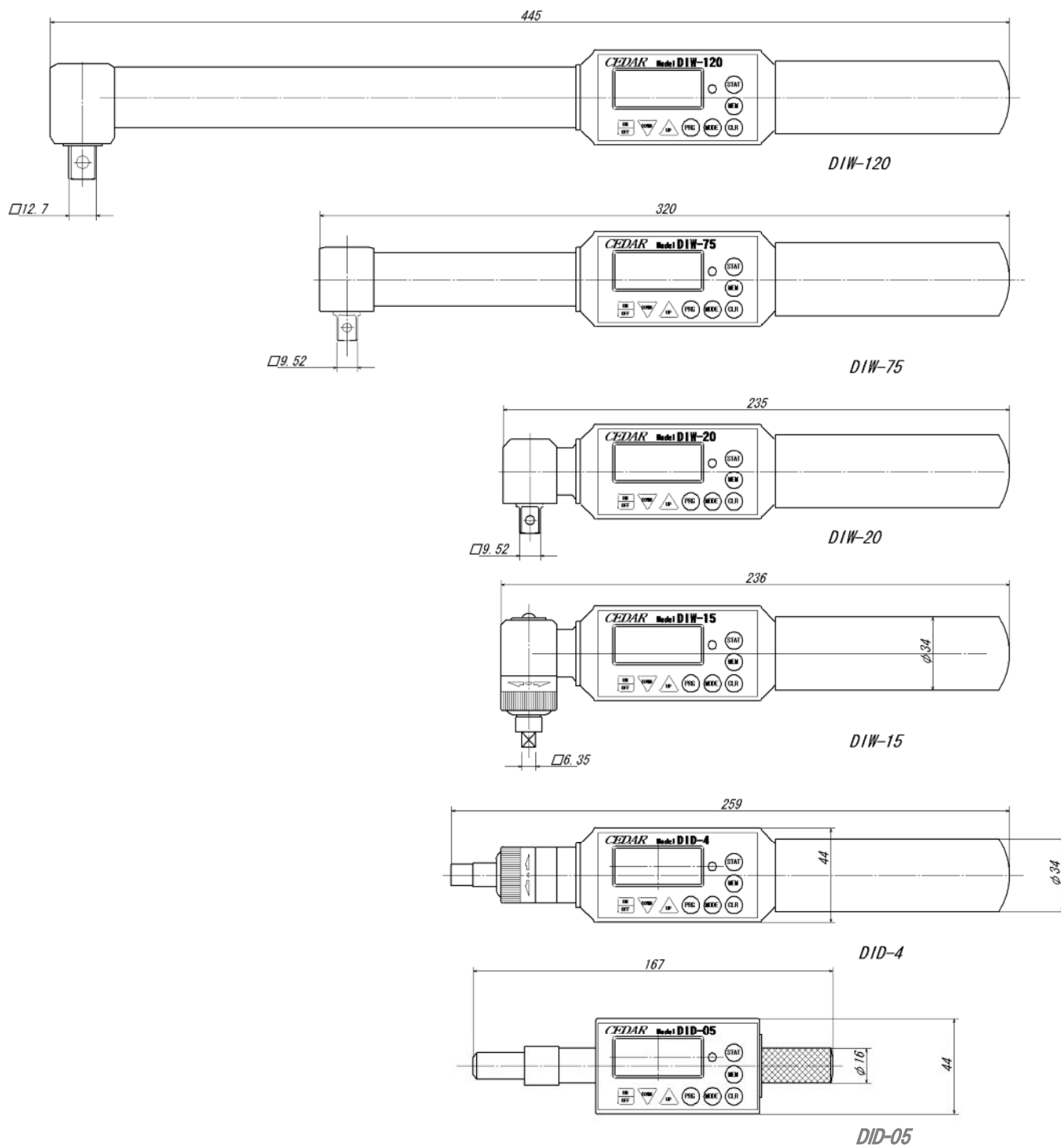

## 2.2 Specification

Model		DID-05	DID-4	DIW-15	DIW-20	DIW-75	DIW-120
Accuracy guarantee range	mN·m	2.0~500					
	N·m		0.020~4	0.20~15	0.20~20	0.20~75	2.0~120
	kgf·cm	0.020~5	0.20~40	2.0~150	2.0~200	2.0~750	20~1200
	lbf·in	0.020~4.5	0.20~35	2.0~130	2.0~174	2.0~651	20~1040
Accuracy		±0.5% (499 digit or less ±3digit)		±0.5% (199 digit or less ±3digit)	±0.5% (499 digit or less ±3digit)		±0.5% (199 digit or less ±3digit)
Accuracy		±0.5% (499 digit or less ±3digit)					
Display		The 4 figures digital display of LCD					
The measurement direction		CW-CCW (right and left)					
Measurement Mode		P-P (peak to peak) / T-R (track) / P-D (peak-down) / C (Real-time Output)					
High - low limits judging function		High and low value is measurement within the limits, and can be set up.					
Results judgment		It can perform results judgment within the setting.(in P-P mode) It confirms with lamp lighting or a buzzer.					
The Maximum, the minimum, and the average value display		It displays the maximum, the minimum, average value (As opposed to a maximum of 800 data)					
Real-time Output		Load torque value is outputted every about 1/ 160 second. (A change whole 1 / 12 seconds is possible)					
Data memory		Measured value - 800 data					
Data output		ASCII format (baud rate 19200)					
Automatic clear time		In 0.1 - 3.0 seconds (0.5 seconds interval) an indication is automatically given zero. It is a manual zero clearance by 0.0 second setup.					
One-touch zero		By pushing a clear button, zero adjustment can be performed by one-touch.					
Battery		Ni-MH battery (650mAh)	Ni-MH battery 1.2V×4cells (800mAh) /300 times or more charge life				
Auto power OFF		Power-supply OFF is carried out after the neglect during 10 minutes.					
Charge time / use time		About 3 hours / About 12 hours use consecutive at full charge time					
Accessories		DID-05	DID-4	DIW-15	DIW-20	DIW-75	DIW-120
		Bit φ 4 ⊕ #1	Bit 6.35HEX ⊕ #1/#2	—	One-way socket		
		An exclusive case					—
		An AC/DC adaptor					
		Result of calibration , Certification on calibration , Traceability system figure					





### 3 Preparation of Measurement

It prepares and checks, before starting measurement.

#### 3.1 Measurement Mode

About the measurement mode which can be measured from this model (measuring method).

##### 3.1.1 Measurement Mode

Measurement mode	Display	Contents
P-P (peak to peak)	Display section「PP」 	The maximum under measurement is always displayed. Load holds more than from 20digits*. Usually, this mode is used.
P-D (peak-down)	Display section「PD」 	A value when a load torque value changes from a rise to descent is displayed. Since the downward width to judge can be changed, measurement appropriate for various conditions is possible. It carries out once it pushes a clear button, when applying re-load. Load operates more than from 20digits*. It is suitable for measurement of a torque wrench etc.
C (Real-time Output)	Display section「C」 	The data output of the load torque value is carried out every about 1 / 160 seconds. (A change whole 1 / 12 seconds is possible) It is suitable for torque curve creation or a screw bundle examination.
T-R (track)	There is no indication. 	It is mainly used at the time of calibration etc. The value of the load torque concerning a detector is displayed as it is. (There is no display.)

\* digit -- DID-4 -- 20digit is 0.020N-m.(0.20kgf-cm/0.20lbf-in)  
DIW-120-- 20digit is 2.0N-m.

##### 3.1.2 A setup and Change in Measurement Mode

Button to be used -- "MODE"

Pushing the "MODE" button is continued for about 1 second.

( It is a setting mode pushed long so that the measurement should not change while measuring it. )

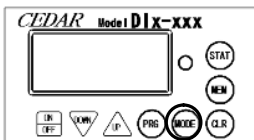

The measurement mode display changes.

The measurement mode to be used is chosen.

The display changes sequentially if it keeps pushing.

Truck (with no display) -> Peak hold (PP) -> peak down( PD) -> Real-time output (C) -> Truck

##### 3.1.3 Setup and Change of Measurement Unit

The unit to measure can be changed.

A change is mentioned later.

It can set up as one of the setting items of "convenient functional 5.2 Numerical value."

For details, please look at "5.2 Setup of (9) measurement unit."







### 3.2 Power Source

This model is using the "Ni-MH charge battery." Charge it with an AC/DC exclusive adaptor.

The display of battery residual quantity is displayed on the display upper part.

The meaning of a display

Display	Contents
	There is battery residual quantity.
	Battery residual quantity has decreased. It charges soon. When using many lamps, such as a yes-no decision, and buzzers, it charges a little early.
	There is almost no battery residual quantity. It charges urgently.
	When there is no battery residual quantity, a power source is shut off immediately.

Charge uses an AC-DC **exclusive adaptor** by all means.

If key operation is not performed for 10 minutes, a power source will be in an OFF state automatically.

When you turn off the power, push an ON/OFF button lightly for about 1 second.

\* If an AC/DC adaptor is connected, a display may be a full display,

**but while the pilot lamp is on, continue charge.**

**\*Measurement while charging cannot be performed. A plug is pulled out at the time of measurement.**

### 3.3 About zero adjustment

At the following, this tester is performed zero adjustment automatically.

1. When power is switched on
2. When measurement mode is changed

(When torque started during this movement,

it becomes impossible for 0 points to shift, and to do a normal measurement.

**At the time of power supply injection and the measurement changing, confirm that torque does not started.)**

Moreover, zero points might shift when zero points do not return.

In that case, zero points adjustments by the following methods.

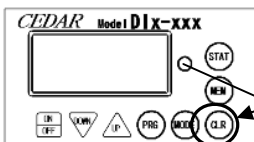

1. Check that torque has not started a detector
2. If CLEAR is kept pushed, Red LED will switch on the light.  
If the light is switched on, the CLEAR button will be detached promptly.
3. Red LED will disappear, display will be zero, zero adjustment is completed.

\*When continue pushing it in a state with the red LED, display it with ALL and become all elimination of memory data. (Leave Red LED unattended. It will be zero.)

## 4 Measuring Method

### 4.1 The common operation method

- 1) Attach the suiting bit and socket.
- 2) Check whether the display is zero.  
When it is not zero, zero adjustment ("3.3 zero adjustment" reference) is performed.
- 3) When required, set up measurement mode and the numerical value of each function.  
(5 Convenient function refer)
- 4) If screw bundle work is done, a torque value will be displayed on the display section.  
The measured numerical value is read.
- 5) Push CLR and carry out a zero clearance.  
(If the auto clearance is set up by functional setup, a zero clearance will be carried out automatically.)
- 6) When continuing, repeat from 4.
- 7) If work is completed, please carry out power-source OFF.  
(Memory of the contents of each set point is carried out.)

### 4.2 Ratchet one-way function

#### Ratchet mechanism

DID-4M or DIW-15M are equipped with the ratchet mechanism.

Rotate the ratchet section and choose RRC fixation (CW), fixation, and RLC (CCW) fixation .

#### One-way mechanism

DID-05 -- CW/CCW -- both can be measured.



A one-way bit

The bit for fixation

\* It can fast forward in the direction of the right (screw bundle) by roller clutch adoption. A screw can be early turned more to taking a seat. When you use it, carrying out both-directions fixation (loosening measurement of a direction etc.), please use it, substituting for the bit for fixed measurement.

#### The notes in the case of attaching a bit

It has this portion and attachment and removal of a bit are performed. If it works with other portions, exaggerated torque may start and a sensor portion may be damaged.



When the time of CCW measurement and a bit are fixed

The bit for fixation is used. A bit should unite the portion applied a half, should insert it to the back, and check whether CW/CCW is being fixed. Work with a bit holder portion so that big load does not take for a detecting element at this time.

When a one-way mechanism is used by measurement of CW

A one-way bit is inserted.

#### One-way socket

It is attached to DIW-20/75.

If it equips with this socket, in case a screw bundle will be performed, if it carries out by the fast forward mechanism (one-way socket) and a main part is turned several times after that until a screw arrives at the bottom, bolting and measurement can be performed simultaneously.

(Since the one-way clutch is being used for an internal mechanism, in a lock and the return direction, the direction with a bundle becomes free.)

When you use a one-way socket by DIW-75, use it with the torque of 500 kg-cm or less .

## 5 About a convenient function

This model carries various functions convenient to measure.

You can use it more efficiently by using the function satisfied management condition.

### 5.1 Convenient Function

1. The yes-no decision which sets up a maximum value and a minimum value.

The maximum value and minimum value of measured value can be set up respectively.

It is a success judging (Green GOOD lamp lighting) within the limits of an upper minimum value.

A failure judging (Red NG lamp blink) is carried out of the range.

2. The value which starts the measurement at the time of peak-down mode can be set up.

When measuring a torque driver/wrench etc., the unrelated torque change at the time of a measurement start can be disregarded.

3. The value which starts the output at the time of real-time output mode can be set up.

4. Time to be automatic and clear the display of a measurement result can be set up.

5. How to sound buzzer sound can be chosen.

### 5.2 The setting method of a convenient functional numerical value

The numerical value for using a convenient function is set up.

PRG, and UP and DOWN are used.

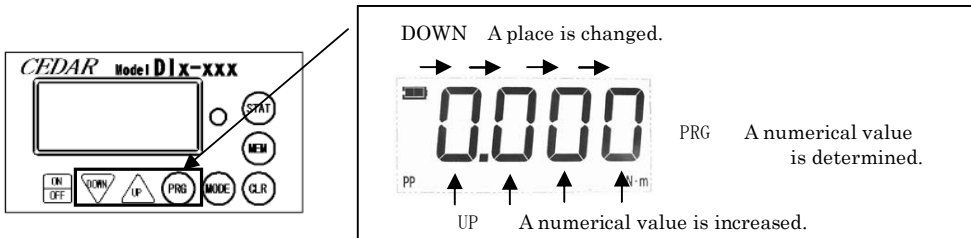

#### 1. Change in Setting Mode, and Setup of Channel

If it continues pressing the PRG key for about 1 second, green LED (GOOD lamp) will stick, The channel set up now is displayed.

The channel which wants to change a channel or the contents to use is set up by the UP key or the DOWN key. (ch1-ch4)

When you change the channel to be used, please press the "CLR" key after change. When changing the contents of a setting of a channel, the PRG key is pressed again. \* After-mentioned  and  cannot do a setup for every channel.

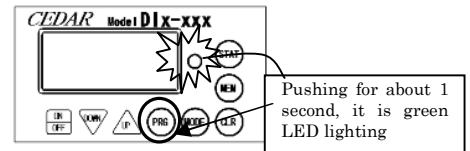

#### 2. Setup of Maximum Value

A maximum value is displayed after displaying  will arrive.

The maximum value is set up by UP and DOWN key.

Since the fourth figure will blink if DOWN key is pressed first, a numerical value is chosen by UP key.

If a setup of a numerical value of the fourth figure finishes, DOWN key will be pressed again. Since the treble figures blink, a numerical value is set up similarly.

The second figures and the first figure are set up similarly.

When a maximum value is set as 1.250

Push DOWN



The fourth figure blinks.

PushUP



The fourth figure blinks by

Push DOWN



The treble figures blink.

It is a numerical increase at UP key. One figure falls by DOWN key.  
If DOWN is pushed again after setting up the first figure,  
since all figures will be displayed, check the set point.

When the setting is corrected, it sets it from the fourth digit again  
pushing DOWN key. If a setup of a maximum value is completed,  
the PRG key will be pressed again.

\* When the PRG key is pressed while setting up, move to the next setting.

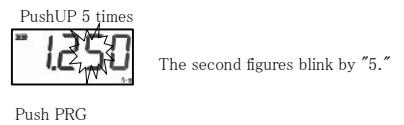
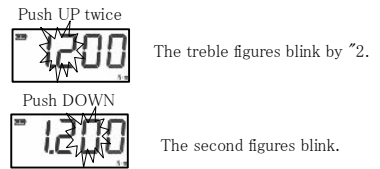

### 3. Setup of Minimum Value

A minimum value is displayed after displaying

The minimum value of torque measurement is set up by UP key  
and DOWN key like a maximum value.

**The a minimum value cannot set a value bigger than  
a maximum limit value.**

If a setup is completed, the PRG key will be pressed again.

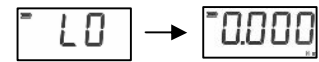

**When a minimum value is set as 1.000**



Push PRG

### 4. Setup of Peak-Down Start Value

After displaying , a peak-down start value is displayed.

A peak-down start value is set up by UP key and DOWN key  
like a maximum value.

( When it fell 15 digits ahead of this value, peak-down displays it.)

If a setup is completed, the PRG key will be pressed again.

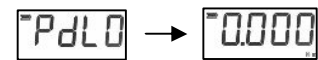

**When a peak down start value is set as 0.600**

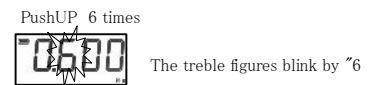
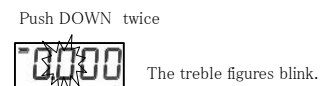

Push PRG

### 5. Setup of Peak Down Judging Numerical Value

After displaying , The judgment numerical value of a peak down  
is displayed. The downward width numerical value of the torque for  
making a peak down judge is set up by the UP key or the DOWN key.

(A setup is [ the whole five ] possible between 5-30)

It decreases by an increase and DOWN by UP.

If a setup of a value is completed, the PRG key will be pressed again.



### 5. Setup of Real-time Output Start Value

After displaying , a real-time output start value is displayed.

A value is set up similarly.

When this value is set to 0, the inside of real-time output mode  
continues outputting data.

The preservation to the memory of real-time data consists of 20 or  
more digits.

When you save in memory, please set this value or more to 20.

If a setup is completed, the PRG key will be pressed again.



**When a real-time output start value is set as 0.010**

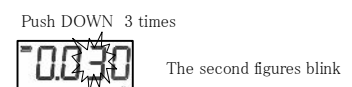

Push UP 8 times



## 6. Auto Clear Setup



After displaying , a time of an auto clearance is displayed.  
Time to carry out the zero clearance of the display is set up by UP or DOWN. (A setup every 0.5 seconds is possible in 0.1 - 3.0)  
It increases by UP. It decreases by DOWN.

Setup-time selection

0.0C-0.1C-0.5C-1.0C-1.5C-2.0C-2.5C-3.0C-0.0C

**If it sets up by 0.0C, it will become the zero clearance in manual operation. \* When set up except 0.0C, a zero clearance is not carried out even if it pushes a Clear key.**

If a setup is completed, the PRG key will be pressed again.

 → 

When auto clear time is set as 1

Push UP twice  

Push PRG/SET

## 7. Setup of a screw bundle number

After displaying , number of counts is displayed.

A screw bundle number is set up by UP or DOWN.

(1-99 Only the direction of the right (CW))

If a setup is completed, the PRG key will be pressed again.

 → 

When a count is set as 10

Push UP 10 times





## 8. Setup of interval time

After displaying , time of an interval will be displayed, set up by UP or DOWN.

(A setup is possible in 2.0 - 24 seconds (every 2 seconds))

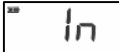
If a setup is completed, the PRG key will be pressed again.

 → 



When interval time is set as 10 seconds

Push UP 10 times



## 9. Setup of Buzzer

After displaying , an ON-OFF-FF setup of a buzzer is displayed. How to sound a buzzer is set up by UP and DOWN.

(: Sound altogether : Don't sound

except exaggerated torque. : Only NG sounds.)

If a setup is completed, the PRG key will be pressed again.

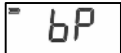
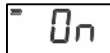
 → 

When setting up for sounding a buzzer

Push PRG/SET

## 10. Setup of Unit

After displaying , It becomes a torque display.

If the UP key is pressed, a measurement unit will change.

If a measurement unit changes, a buzzer will become.

If a setup is completed, the PRG key will be pressed again.



 → 

## 11. End of Setup

It is displayed  and is a setting end. Green LED disappears.

**(The inside of setting mode has turned on Green LED)**

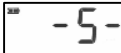
\* When ending a setup on the way, press the CLEAR key.

 → 

It is displayed as -5- and will be in the state where it can measure. Green LED puts out the light.

\* Push MODE key to confirm what you set during setting.

The item of the numerical value set as a display board now is displayed.

( HI , LO , P.d.LO , [LO , AC , bP )



The item under setup is checked.

### 5.3 How to Use Convenient Function

Introduce the method of the measurement using a convenient function.

#### 5.3.1 Yes-no Decision

A measurement result judges the inside of a fiducially point, or the outside of a fiducially point, and tells you about at a lamp or a buzzer.

1. "maximum value" and the "minimum value" that becomes a standard are set. (Reference 5.2)
2. Measurement mode checks in "P-P."(Only measurement mode "PP" of a yes-no decision is effective)
3. When measured value is between a minimum and a maximum, a GOOD lamp lights up.

When measured value is not between a minimum and a maximum, NG lamp blinks and a buzzer sounds.

4. If measurement is completed, the CLEAR key will be pressed and an indication will be given zero.

At same time, the lamp and buzzer of a yes-no decision disappear.

#### **A yes-no decision is performed only when measurement mode is "P-P."(20 or more digits)**

Detection of the value of a peak-down switches on a Green (GOOD) lamp at the time of P-D mode.

#### The buzzer sound of a judgment and the condition of LED

		below low value	in high and low	beyond high value	over-torque
LED	right torque	red long blink	instant green blink	red short blink	red lighting
	left torque		green lighting		
buzzer	right torque	long blink sound	moment sound	short blink sound	continuous sound
	left torque		continuous sound		
		peak down	interval	count O.K.	
LED	right torque	green lighting	red short blink	three green blink	-
	left torque		-	-	
buzzer	right torque	continuous sound	short blink sound	three blink sound	-
	left torque		-	-	

By setup of buzzer sound, it becomes the following operation.

ON: all buzzer sound    OFF: no sound except over-torque    FF: sound only at the time of an error

#### 5.3.2 Maximum, Minimum, and Average

The maximum, the minimum value, and the average value of the measurements data saved can be displayed and checked. However, it becomes calculation of only the data (data of the same measurement direction) of the same mark as a memory number "001" (the first data).

When data 001 is + (the CW direction), only + (the CW direction) is.

- (The CCW direction) Only for - (the CCW direction), a case is.

(1) STAT A key is pressed.

(2) As Opposed to Data Measured and Saved

- 1) The number of data                    -- With no display
- 2) Maximum Torque value            -- "MAX" Display
- 3) Minimum Torque value            -- "MIN" Display
- 4) Average Torque value            -- "AVE" Display

### 5.3.3 To clear indication automatically

When carrying out repeat measurement, even if it does not push the clear button after a measurement end, a display can be cleared automatically.

1. Set up the "auto clear time" of a convenient functional numerical value. ( Reference 5.2)
2. After a measurement end, when setting time passes after a detecting element did not have load, a display will be cleared.

\* When auto clear time is set up, a display is not cleared even if it presses the "CLEAR key."

### 5.4 Real-time data output

A data output (real-time output mode) can be carried out about 160 times in 1 second.

It can switch every 1/ 12 seconds. The change method 「**6.5 Change of Output Speed of Data**」 Reference

1) Set measurement mode as "real-time output" mode.( Reference 3.1.2)

2) If torque load becomes beyond the value  set up beforehand, the data output of the load torque will be carried out.

3) If torque load becomes under , a data output will stop.

\* The preservation to the memory of real-time data consists of 20 or more digits. When you save in memory, set  or more to 20. However, it restricts at the time of a real-time data output, and preservation of data will not be carried out if memory becomes 800 affairs.(Overwrite is not carried out)

\* During a real-time data output, since the torque display changes at high speed, it stops being able to be visible very easily.

\* When the output of data is not carried out by setup of , even if torque has started, the torque display has become with "0."

\* When  is set as "0", the inside of real-time output mode continues taking out data. The data outside the measurement range is used as a reference value.

Although the data near "0" may be fluctuated also in the time of the no-load, it is not failure with the condition on data processing.

## 6 Preservation, Display, and Output of Data

Preservation, a display, and an output can be carried out for data, such as measurement data and the average.

Whenever data press the CLEAR key or require an auto clearance, as soon as memory memorizes, they output a signal also to a data output terminal.

Statistics data output a signal also to a data output terminal at the same time they display data.

### 6.1 Measurement Data

#### 6.1.1 Preservation of Measurement Data

Memory data are always saved, whenever it presses the CLEAR key or an auto clearance starts.

When a lot of data are treated, we recommend you to eliminate data before use.

\* Begin the memory of data from the data number 001. When data are already memorized,

it saves from the following memory number. Preservation of a maximum of 800 data can be performed, and if it exceeds 800 data, it will be overwritten from No. 001. Since front data will disappear, when exceeding 800 data, save them in a personal computer etc.

### 6.1.2 Display and Elimination of Saved Measurement Data

1. If the MEM key is pressed, it will be displayed as "MEM", and the data number and measured value which were saved at the end will be displayed by turns.

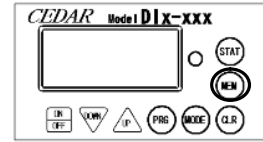

2. If UP key or DOWN key is pressed, a memory number is changed and data can be searched.

If button operation is left for 6 seconds, the "MEM" display will disappear and it will move to measurement mode.

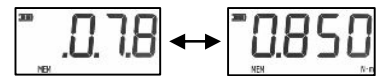

#### \* When memory data are eliminated individually

3. If the CLEAR key is pressed while displaying a memory number and a torque value on alternation, it will blink .

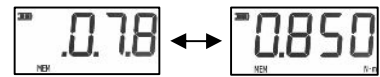

Push CLEAR

4. If the CLEAR key is again pressed during blink, the data which displayed as and were chosen will be eliminated. (Subsequent data slide data to the eliminated portion)



CLR Blink

5. If it is left during blink, it will be in the state which can be measured. (Data are not eliminated)

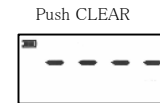

Push CLEAR

Data are eliminated

#### \* When the range is specified and memory data are eliminated

3. Press UP key or DOWN key and display the data of the beginning of data to erase.

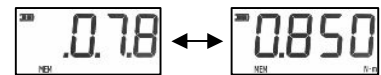

When the data numbers 005-010 are eliminated

Push DOWN

4. If the CLEAR key is pressed while displaying a memory number and a torque value on alternation, it will blink .

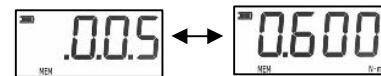

Push CLEAR



CLR Blink

5. Since a data number will increase if UPkey is pressed, display the data of the last of the range to erase.

Push UP

6. If the CLEAR key is pressed while displaying a memory number and a torque value on alternation, the data of the range which displayed as and was chosen will be eliminated.

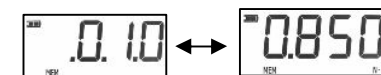

Push CLEAR



Data are eliminated

If no button operations are carried out at this time,

it will check whether it blinks with and eliminates.

When eliminating, the CLEAR key is pressed during blink.

When stopping elimination, it is left as it is.



It returns to a torque display and data are not eliminated.

- \* When memory data are eliminated,  
the data saved after that slide to the data number.

### 6.1.3 Output of Saved Measurement Data

1. A push on the MEM key displays by turns the data number and measured value which were saved at the end.
  2. While displaying a data number and measured value, press the MEM key once again.  
(It becomes data output preparation)
  3. Since a data number is displayed after displaying it as FA (first address), choose the data number of the first data to output by UP or DOWN.
  4. Since a data number is displayed after displaying it as LA (last address), choose the data number of the data of the last to output by UP or DOWN.  
The MEM key will be pressed if selection finishes.
  5. Display it as -P- and output.  
After an output finishes, it returns to a measurement state.
- \* Press the CLEAR key for about 1 second to stop an output during an output.

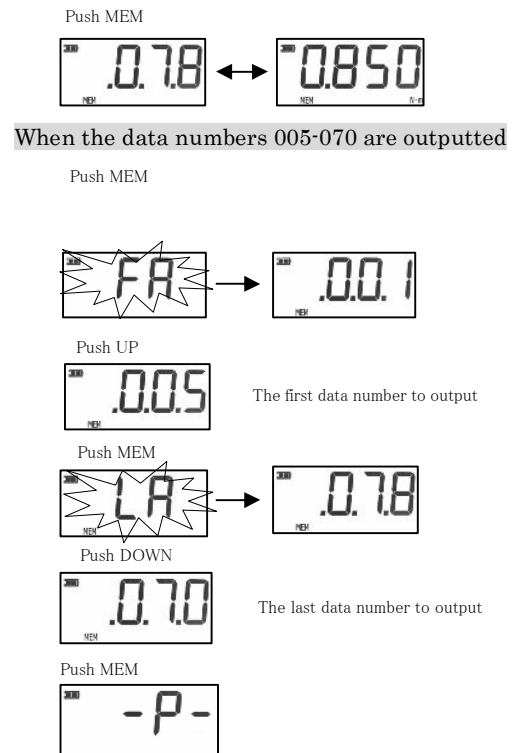

### 6.2 Output data

Output data are outputted in the ASCII format with a USB cable.  
In addition, in order to take in data, a software needs to be installed separately.  
About installation of software

Homepage [http: of our company](http://www.cedar.co.jp/) <http://www.cedar.co.jp/> or  
FTDI Chips Virtual COM Port Drivers <http://www.ftdichip.com/Drivers/VCP.htm>

#### Data Format

Data bit length	start bit 1 + data bit 8 + stop bit 2 + no parity		
Baud rate	19200bps	Connector form	USB (B type)

The format of data has the following two kinds.

#### □Data Format at the Time of Measured Value and Statistics Data Output

18	ooo	OE	20	±	oooo	20	OF	oooooo	OD
CAN	□	SO	Space	Sign	Measured value	Space	SI	Unit	CR
All data 21									

□ Data Format at the Time of Real-time Output Mode

18	±	○○○○	OD
CAN	Sign	Measured value	CR
All data 8			

The contents of data

**CAN**: Cancellation

□ : at the time of a measured-value output

At the time of a memory data output "a data number"

At the time of the output in a clearance "a space"

: At the time of a Statistics Data output "N" The number of data, "MAX" Maximum, "MIN" Minimum value, "m" Average value

**SO** : Double width expansion printing specification

± : Measurement sign + A direction with a bundle - The return direction

**Measured value**: A decimal point is also included. The last is a space when there is no decimal point.

1 0 . 0 0 ---- 10.00

**SI** : Double width expansion printing release

**Unit** : In N·m etc., the remainder is a space.

N · m ( k g f · c m ---- kgf·cm )

**CR** : Carriage return

6.3 All Elimination of Saved Data

1. When carrying out package elimination of all the data, it continues pushing until it displays as ALL by the CLEAR key. (About 4 seconds)

\* Push continuously, and after a while (about 2 seconds), although Red LED switches on the light, it continues pushing as it is.

2. If the CLEAR key is again pressed during ALL blink, it will be indicated by blink with CLA.

3. If the CLEAR key is pressed again, it will be displayed as ---- and all data will be eliminated. (The setting numerical value of each function is not cleared)

\* When operation is left during ALL · CLA blink, it will be in the state which can be measured. (Memory is not cleared)

6.4 Change of Output Speed of Data

The speed of the output at the time of outputting the data saved can be changed.

A. For Printer Output (Low Speed) -- Setup "00"

B. For Personal Computer Output (High Speed) -- Setup "01"

This setup is adapted also for the change of the output timing of real-time output mode.

A. Low Speed (Every about 1 / 12 Seconds) -- Setup "00"

B. High Speed (Every about 1 / 180 Seconds) -- Setup "01"

(It is set as "01" at the time of purchase.)

The change of a setup is performed by the following methods.

1. In the state of a power source OFF, pressing the PRG key, press the ON/OFF key and switch on a power source.
2. If the PRG key is detached, it will be displayed as "01" or "00."

Since it will change if UP key is pressed, a setup is chosen.

3. If the PRG key is pressed again, after displaying it as -5-, it returns to a torque display, and will be in the state which can be measured.

## 7 System Reset

CPU in the tester might not start even if the battery charges it with electricity complete discharged. (When not using it for a long term)

In that case, An AC/DC adaptor is connected and a system reset button is pushed.

It will be in an initial state (all the contents of memory are eliminated).

Do not use it excluding the following condition.

- \* When the display doesn't appear even if this machine is not used for a long term and charged.
- \* Additionally, when the tester doesn't work.

Since all the contents of memory are eliminated when system reset is performed, redo a setup once again.

## 8 Calibration Trust Service

### 8.1 Periodical calibration

A regular proofreading is necessary to manage the accuracy of torque tester.

By our company, the proofreading with the high reliability traced to the national standard is performed, and in order to use it within accuracy, I recommend you one proofreading per year.

(Periodical calibration is a charge.)

An inspection report, a proofreading certificate, and traceability system figure attachment

### 8.2 Guarantee

Although manufactured under sufficient quality control, if the fault which originates in manufacture, transportation, etc. of our company within one year after a purchase should occur,

I will fix this machine gratuitously.

In the following case, it becomes a charge within the term of a guarantee.

Failure and damage by the error, and unjust repair and reconstruction on use

Failure and damage by the natural disaster, pollution, unusual voltage, etc.

### 8.3 When Troubled

The checkpoint when being troubled. Before judging it as failure

When functional fault arises, check based on the following table.

By the corresponding processing, when fault is not canceled, tell repair to our company or a store.

In addition, I am allowed to make a torque tester's term of a guarantee into one year from a purchase.

(It is for a fee depending on the content of the repair.)

condition	checkpoint	solution
A power supply is not turned on.	Is charge carried out?	Carry out regular time charge using the exclusive charger attached.
The power supply cuts at once even if it turns on power.	Charge is insufficient.	Carry out regular time charge using the exclusive charger attached.
It does not display, even if it switches on a power supply after charge of regulation time.	If it is not used over a long period of time, an internal battery will carry out full electric discharge.	An AC/DC adaptor is connected and a system reset button is pushed. After a return, push a clear button and give an indication zero.
It cannot measure.	When torque is applied, does a numerical value change?	The gauge may be damaged when not changing. Request repair.
	Is it the numerical value of each function under setup?	End a setup and return to measurement mode.
A display disappears immediately.(It does not hold by measurement mode PP/PD)	It is used setting up an auto clearance.	Check the setting item of an auto clear function again. When there is no necessity, set it as 0.0C.
A zero point cannot be taken.	Did you clear and make it zero?	"3.5" is seen and zero adjustment is performed.
By real-time output mode, even if it imposes torque, a display does not change. Data are not outputted.	Torque has not reached a real-time output start value.	At real-time output mode, when torque is under a "CLO" real-time output start value, a data output does not give an indication with "0", either. Change the value of "CLO" into a suitable value.

Use a wish attached case and a plastic Case as an object for storage of a measuring instrument.

Moreover, when you convey this product to our company by check, proofreading, repair, etc.,

for product protection, put into this case and is sure to send.

<p><b>For any inquiry, Contact your dealer.</b></p>	<p><b><i>CEDAR</i></b></p> <p><b>-ISO9001-</b></p> <p>E-mail <a href="mailto:sales@cedar.co.jp">sales@cedar.co.jp</a> Homepage <a href="http://www.cedar.co.jp">http://www.cedar.co.jp</a></p> <p><b>SUGISAKI METER CO.,LTD.</b></p>
---	--